

PVC-U

Pipe, Fittings & Valves
for drinking water, chemicals,
sea water, de-mineralised and
de-ionised water, food and
beverage, waste and general
purpose water

Technical Information 2012

Technical Information

For technical data including operating & control pressures, dimensions as well as the use of accessories, please refer to data sheets which are available in both printed and electronic (pdf) formats from the Coventry Sales Office (details on back cover).

For details of our range of plastic pipe, fittings, hand and actuated operated valves in ABS, PVC-C, PP, PVDF, PFA and PE as well as our INSTAFLEX PB and SIGNET measurement and control range, please request details from the Coventry Sales Office or go to www.georgefischer.co.uk

Important Note

The technical data given in this catalogue is for preliminary information purposes only and is published without guarantee. All pictures and drawings are for illustrative purposes only and should not be regarded as wholly accurate in every detail. We reserve the right to withdraw or to alter the specification of any product without notice. Please consult our Terms and Conditions of sale.

www.georgefischer.co.uk



PVC-U Lifetime Warranty

GF PVC-U

What do we offer?

The warranty applies to all PVC-U products with the GF trademark according to metric norm and the British Standard purchased after January 1, 2007. Defective products are immediately replaced by new products of equal value.

Why are we offering this extended warranty?

We want to confirm our confidence in the premium quality of our PVC-U products.

What does the warranty cover?

A lifetime warranty against product failure caused by defects in the product or the material under normal use. By normal we mean conditions as authorized for PVC-U in our planning fundamentals at the time of installation.

What is not covered?

Not covered under warranty are exceptional wear and automation components. Since this is a product guarantee, further legal claims for installation costs or consequential damages of any kind are not included.

Whom does this warranty benefit?

The original owner may put forward a claim directly to Georg Fischer under this warranty. The distributor or seller does not need to be contacted.

How to make a claim?

A complaint is submitted to Georg Fischer including the completed claims sheet and the imperfect part/parts. We promise fast processing of the claim.

How long does the warranty last?

It is effective for the whole planned useful life of the system in which the products are used. For applications with water as the medium this is generally 25 years.

What do you receive from GF in case of claim?

You will receive immediate confirmation of receipt of your complaint and an investigation of the cause of failure will begin within two weeks. For justified complaints you will promptly receive a replacement of the defective parts or products of equal value and function.



Lifetime Warranty for PVC-U Products

What this warranty covers

This Lifetime Warranty is provided to the original user of PVC-U Products (Valves, Fittings and Pipes) marked with the trademark +GF+ sold by Georg Fischer Piping Systems Ltd or its affiliated companies ("George Fischer") as of January 1, 2007.

Georg Fischer warrants that the PVC-U Products, under normal conditions will be free from defects in material and workmanship during their whole useful life.

This Lifetime Warranty applies exclusively to PVC-U Products in accordance with DIN/ISO Standard 15494 and BS EN 1452.

How long this warrant lasts

This Lifetime Warranty lasts, as long as the original user owns the PVC-U Product, for the whole useful life of the PVC-U as defined in Georg Fischer's design fundamentals.

What Georg Fischer will do

At Georg Fischer's option, Georg Fischer will repair, replace or substitute a defective PVC-U product with a PVC-U product of equal value and function.

What this warranty does not cover

This Lifetime Warranty does not apply to one or more of the following:

1. PVC-U Products that have been subject to abuse, misuse, neglect, accident, improper installation, improper storage, improper handling or adjustment, or corrosion.
2. Acts of God, including, but not limited to flood, fire hurricane, tornado, earthquake, electro-static or any other similar natural cause beyond the control of Georg Fischer.
3. PVC-U Products that have been modified or altered outside of or beyond Georg Fischer specifications.
4. PVC-U Products used in application other than those recommended by Georg Fischer, either in its most recent catalogue or in the instructions accompanying the PVC-U Products.

5. Freight charges, installation cost, labor cost, damage to related components, cost incurred due to down time, other incidental or consequential damages of any kind, and normal wear and tear of the product.
6. Electrical and pneumatic devices for PVC-U Valves.
7. PVC-U Products not specified to DIN/ISO 15494 and BS EB 1452 (e.g. ASTM Schedule 40/80, JIS-Standard).
8. PVC-U Products which have been resold or otherwise disposed of by the original end-user.

How to make a claim

To make a claim under this Lifetime Warranty, the PVC-U Product must be returned to Georg Fischer for evaluation and disposition. When returning the product back to Georg Fischer, please include (i) written proof of purchase, which includes the date, amount and place of purchase; (ii) a written description of the claimed defect(s) using the GF claims sheet (available through the local GF sales company) with a photo of the application, if possible.

Georg Fischer shall have two (2) weeks following receipt of any PVC-U Product returned for warranty claim to begin the investigation of the claimed defects, and the original user or authorised distributor shall give Georg Fischer (or its agents) reasonable access to the application, if possible.

Each of the above mentioned terms must be met in order to qualify for the Lifetime Warranty coverage.

Exclusive remedy

Georg Fischer's Lifetime Warranty and remedies set forth herein are the original user's sole and exclusive remedies in relation to Georg Fischer, and are offered by Georg Fischer in lieu of all other warranties, guarantees, and/or remedies whatsoever, including, but not limited to, implied warranties of merchantability and/or fitness for a particular purpose, or other warranties or guarantees arising by operation of law, which are hereby, to the extent permitted by applicable law, expressly disclaimed.

In no event shall Georg Fischer be liable to the original user or authorised distributor or third parties for lost profits, consequential, incidental, punitive, exemplary or other similar damages.

This Lifetime Warranty gives the original user certain specific legal rights, and the original user may also have other rights that vary from country, in particular warranty rights under the purchase contract concluded with his dealer. Some laws do not allow the limitation/exclusion of incidental or consequential damages, particularly for injury to or death of persons, or otherwise restrict the limitations contained herein, so some of the exclusion above may not apply to you.

PVC-U



+GF+

+more

- + Over 50 Years Experience
- + Lifetime Warranty
- + Worldwide Approvals
- + Superior Raw Materials
- + Worldwide Availability
- + Complete PVC-U System
- + Proven Joining Technology
- + Added Value with the PRO-FIT System
- + Worldwide Technical Training & Support
- + CAD Database & Calculation Tools



Optimal Cost of Ownership

Adding Quality to People's Lives
www.piping-germany.com/en

50 years of application knowledge

GF PVC-U

Water, drinking water & chemical conveyance

Fields of Application:

- Water treatment
- Chemical industry
- Drinking water
- Swimming pools
- Marine industry
- Food and beverage production

Product Range

- Pipes
- Fittings
- Manual valves
- Actuated valves
- Pressure safety valves
- Jointing systems
- Flow, pH, conductivity, turbidity, chlorine, level, pressure, and temperature measurement

Available in the widest standards available: BS Inch, EN/ISO metric
ASTM/ANSI SCH80 and JIS:

EN/ISO - 6 - d400mm

BS Inch - 3/8" - 8"

ASTM/ANSI - 1/2" - 16" ASTM SCH80

Application range:

Resistant to acids and alkalis. Suitable for drinking water, food stuffs and beverages, de-mineralised and de-ionised water, paints, sea water, waste and general purpose water.
0°C to 60°C

Jointing system:

Tangit (or Dytex for aggressive chemicals) gap filling solvent weld system.

Worldwide Approval

GF PVC-U is manufactured and tested to the highest quality. Our own compound and strict quality controls for each raw material delivery form the basis for our high quality products.

Our own independently accredited test laboratory for components of plastic piping systems according to EN ISO 45001 assures the highest quality.

Quality and environmental management systems according to ISO 9001 and 14001 are the basis for the continuous improvement of our performance.

Third party approvals for GF PVC-U offer peace of mind to customers using the products.



Distribution, Warehousing and Technical Support

The excellent location of the Distribution Centre in Coventry offers the latest in state of the art distribution and warehousing systems. An enhanced delivery system and 24 hour warehousing programme guarantees prompt delivery to GF customers nationwide.

Our Technical support staff are qualified to offer you advice and guide you through the wealth of products GF can supply. We make sure you feel confident that the product matches your requirements and leaving you fully assured that GF is your preferred supplier.



GF Fleet of delivery vehicles



Tracking delivery of your order

Automation

GF manufacture a complete range of actuators and actuated valves which includes pneumatic as well as electric actuators. Thanks to their modular design, the actuators can be configured specifically to your application (eg. positioner, additional limit switches, fail-safe unit, AS-Interface connection, etc.) Housing material is robust and resistant PPGF. All actuators are sized specific to GF valves, resulting in an increased service life. Connections to third party valves are no problem due to EN ISO 5211 interface.

SIGNET

The GF Signet range of flow control and measurement equipment is at the cutting edge of technology in this field.

Flow, pH, level, conductivity, temperature, turbidity, chlorine, pressure and ORP are all catered for within the range.



Materials used for industrial pipe work

The material polyvinyl chloride unplasticized (PVC-U)

PVC-U properties (reference values)

Characteristics	Value	Units	Test Standard
Density	1.38	g/cm ³	EN ISO 1183-1
Yield stress at 23 °C	≥ 52	N/mm ²	EN ISO 527-1
Tensile e-modulus at 23 °C	≥ 2500	N/mm ²	EN ISO 527-1
Charpy notched impact strength at 23 °C	≥ 6	kJ/m ²	EN ISO 179-1/1eA
Charpy notched impact strength at 0 °C	≥ 3	kJ/m ²	EN ISO 179-1/1eA
Ball indentation hardness (358N)	≥ 105	MP	EN ISO 2039-1
Heat distortion temperature HDT A 1.80 MPa	66	°C	EN ISO 75-2
Vicat heat distortion temperature B/50N	≥ 76	°C	ISO 306
Thermal expansion coefficient	0.07 ... 0.08	mm/m K	DIN 53752
Heat conductivity at 23 °C	0.15	W/m K	EN 12664
Water absorption at 23 °C	≤ 0.1	%	EN ISO 62
Colour	7011	-	RAL
Limiting oxygen index (LOI)	42	%	ISO 4589-1

General

Polyvinylchloride, widely known by its abbreviation PVC, is one of the most important and oldest mass-produced polymers. World-wide consumption of PVC is only exceeded by PE and PP, PVC was first produced in the middle of the nineteenth century. An industrial production process was, however, first patented in 1913. Nowadays, many industrial applications couldn't be realised without PVC. But also in the use of daily products, PVC has become irreplaceable.

PVC is a polymer having approximately 56 % by weight of chlorine. Only by using additives does it become a processable and usable material. The additives allow a wide variation of its characteristics and allows it to be adjusted to the planned application. There are two classes of PVC materials. Soft PVC (PVC-P), produced by adding plasticizers (such as, e. g. phthalate), is not used by GF. Hard PVC, the so-called unplasticized PVC (PVC-U) is used for pipeline engineering.

PVC-U is an amorphous thermoplastic. The characteristics of PVC-U moulded parts are strongly dependent on the composition of the formula, but also on the processing. Because of our 50-year experience in PVC processing and the continuous advancement of our own formula, GF has become a benchmark in the field of PVC-U piping.

GF's PVC-U is characterised by the following characteristics:

- universal use
- very good chemical and corrosion resistance
- proven physiological harmlessness and therefore suitable for contact with food
- no influence on drinking water quality
- biologically inert; no support of microbial growth
- high mechanical tensile strength with good impact strength
- self-extinguishing
- secure solvent cementing using Tangit® and Dytex®
- adhesive development designed for GF PVC-U
- use of tin stabilisers for fittings and valves
- low friction loss owing to smooth surfaces
- recyclable

Mechanical properties

PVC-U from GF reflects a balanced picture regarding the mechanical short-term properties. Because of the strong interaction between the chlorine atoms in the polymer chain, PVC-U shows a high tensile strength and stiffness. At the same time, the elasticity of the GF structural parts is good, a characteristic guaranteed by regular quality control testing.

The long-term behaviour for internal pressure resistance is provided by the hydrostatic strength curve based on the EN ISO 15493 or DIN 8061 standards (also see the Calculation and Long-Term Behaviour of PVC-U section). The application limits for pipes and fittings, as shown in the PVC-U pressure-temperature diagram, can be derived from these curves.

Behaviour during dynamic loading corresponds to the highest quality requirements and is tested regularly.

Chemical and weathering resistance

The outstanding chemical resistance of PVC-U extends to high concentrations. Resistance against the influence of most mineral acids, bases and salt solutions and also sodium hypochlorite solutions is very good. Resistance to aliphatic hydrocarbons and elemental chlorine is also good. PVC-U, in general, shows weakness against aromatic or chlorinated solvents, esters and ketones. Use with gases is also not recommended. If the use of oils, varnish or fats is being considered, a prior investigation is advisable.

For detailed information, please refer to the detailed list of chemical resistance from GF or contact your GF subsidiary.

These specifications are also valid - with exceptions - for adhesive joints, which normally are implemented by applying strongly dissolving gap-filling solvent cement to the PVC-U.

PVC-U is very resistant to weathering. Long-term influence of direct sunlight as well as the effect of wind and rain damage the material only superficially. Despite its very good weathering resistance regarding ultraviolet radiation, PVC-U loses some of its impact strength. In extreme applications it can be advantageous to protect the material from direct sunlight exposure.

Thermal properties

PVC-U shows very good characteristics in the temperature range from 0 to 60 °C. At lower temperatures, the impact strength drops considerably. Tensile strength and stiffness drop with increased temperatures. Please consult the pressure-temperature diagram especially for your maximum working temperature. Because the softening-point temperature of the fitting and valve materials lies above 76 °C, applications must remain limited to temperatures below 60 °C.

The thermal expansion coefficient of PVC-U at 0.07 to 0.08 mm/m K lies clearly above that of metals. Of all the materials for industrial piping installations, available from GF, PVC-U shows one of the lowest expansion coefficients. Nevertheless, the thermal expansion has to be taken into account during the planning of the installation.

Similar to all polymers, PVC-U is a good thermal insulator. At 0.15 W/m K, the heat conductivity of PVC-U is very low. The value for steel, on the other hand, is 250 W/m K.

Combustion behaviour

The high chlorine content of PVC-U causes an advantageous combustion behaviour. Self-ignition resulting from temperature influences occurs only at 450 °C. PVC-U burns when exposed to an open flame, but extinguishes immediately after removing the flame.

The oxygen index amounts to 42 %. (Materials that burn with less than 21 % of oxygen in the air are considered to be flammable).

PVC-U thus falls in the best flammability class V0 according to UL94, and in the B1 building material class (difficult to ignite) according to DIN 4102-1. According to the French test method NF P 92-501, GF PVC-U is tested as M2.

Because the combustion of PVC produces hydrogen chloride, which forms a corrosive acid in connection with water, immediate cleaning of areas susceptible to corrosion is necessary after a fire. Danger to personnel from HCl is minimal because its pungent odour allows early escape from toxic combustion gases, mainly from the odourless carbon monoxide.

There are no restrictions concerning the choice of fire-fighting agents.

Electrical properties

PVC-U is, as all unmodified thermoplastics, non-conductive. This means that no electrochemical corrosion takes place in PVC-U systems. On the other hand, these non-conductive characteristics have to be taken into account because an electrostatic charge can develop in the piping. It is especially important to take this condition into account in areas where explosive gases can appear. There are various methods available to

avoid the occurrence of electrostatic charges on polymer piping systems. Please contact your GF representative for more information regarding these methods.

The specific volume resistance is $>10^{16} \Omega\text{cm}$.

Physiological properties

The PVC-U formulas were developed by GF for use with drinking water and food. PVC-U's physiological harmlessness regarding neutral, acidic and alcoholic foods and the non-influence on drinking water in respect to odour, taste or microbiological effects is regularly checked and monitored by neutral institutions in various countries.

GF offers PVC-U systems free from lead and cadmium for your applications in the fields of drinking water or food. The residual monomer content of vinyl chloride lies below the detection limit of modern analytical methods.

Design of metric and inch piping systems

Application area of pipes and fittings

Pressure/temperature diagram for PVC-U

The following pressure/temperature diagram for PVC-U pipes and fittings is valid for a lifetime of 25 years.

The design factor of 2.5 recommended by GF is incorporated.

It can be used for water or media resembling water, in other words, media which have no derating factor regarding the chemical resistance.

Remark: Please take into account the pressure/temperature diagrams for valves and special fittings. Because of the construction and/or sealing material used, differences are possible when compared with pipes and fittings. This information can be found in the planning fundamentals of the relevant types of valves, respectively special fittings.

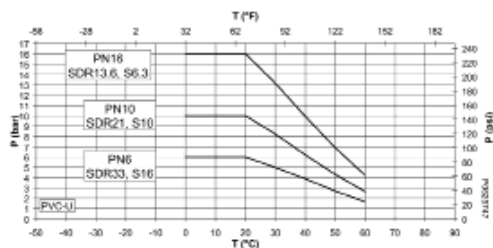

P Permissible pressure in bar, psi

T Temperature in °C, °F

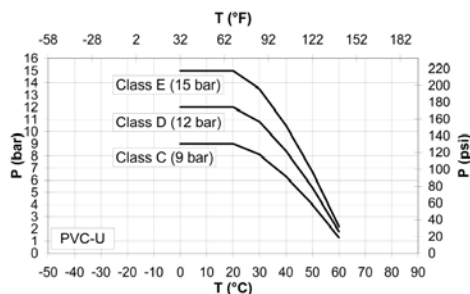

Attention: PVC-U solvent cement jointing fittings d200 to 280 from Georg Fischer are designed and tested to a nominal pressure of PN10. Sizes d315 to d400 are designed and tested to a nominal pressure of PN6.

Our experience and tests show that pipes equal or greater than d315 can be slightly oval, which could produce a heightened cementing gap.

Georg Fischer therefore recommends, that pipes equal or greater than d315 should be operated at a maximum working pressure of 6 bar. Please observe also the special information for these dimensions in the solvent cementing instruction for PVC-U.

Application area of pipes and fittings

BS Inch, metric, and SCH80 industrial piping systems

Georg Fischer offers an unrivalled range of PVC-U systems in both metric and inch sizes. The pressure and temperature ratings for pipe, fittings and valves of each system are valid for a lifetime of 25 years at their maximum rated pressure at 20°C water.

For those unfamiliar with the difference between metric / inch sizes the following note may be helpful.

In imperial systems, the sizes of pipe, fittings and other components such as valves are designated throughout by reference to the nominal size of the bore of the pipe expressed in inches and fractions of an inch. In metric systems, however, sizes are designated by reference to the outside diameter of the pipe expressed in millimetres. Some valves are only available in metric sizes, for which a range of millimetre / inch adaptor fittings is available to install these metric valves into inch systems.

It should be understood that metric sizes are not simply inch sizes which have been converted into millimetres and called metric; their actual dimensions are slightly different, and they are, with the exception of 2 1/2" (75mm) and 5" (140mm) not interchangeable without inch / metric adaptors.

BS Inch system

PVC-U pipes according to BS EN 1452 and fittings according to BS 4346 are available from 3/8" – 8" and use the class system of pressure rating, unless otherwise indicated the maximum pressure ratings are as follows:

Pipes:

Class C	2" – 8"	9 bar
Class D	1 1/4" – 4"	12 bar
Class E	3/8" – 5"	15 bar
Class T	3/8" – 2"	12 bar

Fittings:

Class E	3/8" – 6"	15 bar
Class C	8"	9 bar
Threaded	1/4" – 2"	9 bar

ASTM SCH80 – Inch Sizes

Dimensionally matched for use with all inch size fittings, SCH80 PVC-U pipe manufactured in accordance with ASTM requirements is available in sizes 1/2" – 16" and has a minimum burst pressure rating that changes according to the pipe nominal bore size. The pressure ratings for each pipe size are available for reference next to each pipe product code. However the advised working pressure ratings for ASTM SCH80 pipe and fittings are as follows:

1/2" – 6"	15 bar
8" – 16"	9 bar

Fittings 10" and above in this catalogue are all manufactured to ASTM requirements.

Metric Sizes

PVC-U pipes and fittings in accordance with EN 1452 / EN 15493 / DIN 8062 are available from 6 – 400mm and use the nominal pressure (PN) method of pressure rating, unless otherwise indicated the maximum working pressure ratings are as follows:

Pipes:

PN4	75 – 315mm	4 bar
PN6	50 – 400mm	6 bar
PN10	25 – 315mm	10 bar
PN16	6 – 160mm	16 bar*

Fittings:

PN16	6 – 160mm	16 bar
PN10	200 - 315mm	10 bar
PN6	315 - 400mm	6 bar
Threaded	1/4" – 2"	10 bar

*GF metric PVC-U pipe with wall thickness greater than specified in EN 15493 for industrial applications

Installation of metric industrial piping systems

Change in length and flexible sections

Introduction

General

Thermoplastics are subject to greater thermal expansion and contraction than metals. Pipes installed above ground, against walls or in ducts, especially those exposed to temperature variations, require changes in length to be taken up in order to prevent extra strain on the pipes. Length changes can be taken up by:

- a) flexible sections
- b) compensators

Flexible sections are the most common solution, being the simplest and the most economical. The calculations for and the positioning of flexible sections are therefore described in detail.

Fundamentals

The low modulus of elasticity of thermoplastics allows changes in length to be taken up by special pipe sections, where pipe supports are positioned so that they can take advantage of the natural flexibility of the material. The length of such sections is determined by the diameter of the pipeline and the extent of the thermal expansion to be compensated.

Flexible sections arise naturally at any branching or change in direction of the pipeline. The movement LB of the flexible section as a result of a change ΔL in the length must not be restrained by fixed pipe brackets, protrusions wall, girders or the like.

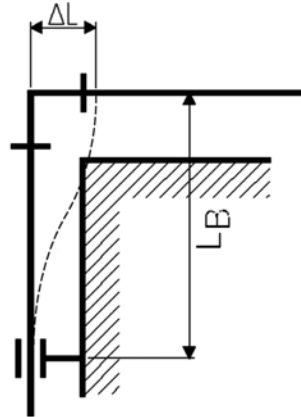
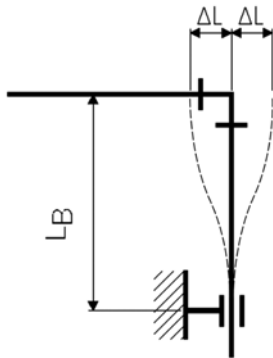

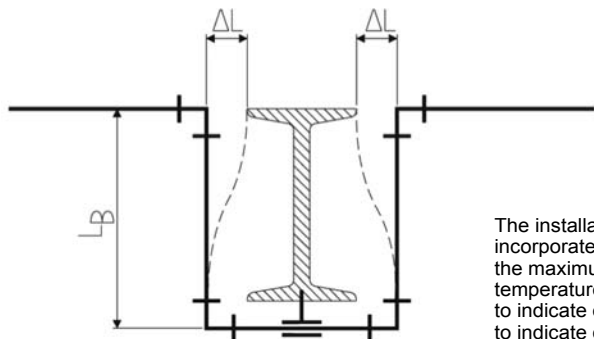

The installation temperature must therefore be incorporated into the calculations as well as the maximum and minimum operating temperatures. It is preferable to use "+" to indicate expansion of the pipe and "-" to indicate contraction. The larger change in length is the one to be used for determining the required length of the flexible section.

Calculation of change in length

The change in length caused by temperature can be calculated using the following formula:

$$\Delta L = L \Delta T \alpha$$

with:

- ΔL = temperature-related change in length (mm)
- L = length of the pipe section (m)
- ΔT = difference of temperature (K)
- α = coefficient of linear expansion (mm / m K)



Coefficients of linear expansion of polymers:

Material	α in mm/m K
ABS	0.10
pre-insulated ABS	0.02 - 0.08*
PA	0.10
PB	0.13
PE	0.15 - 0.20
PP	0.16 - 0.18
PPS	0.15
PVC-U	0.07 - 0.08
PVC-C	0.06 - 0.07
PVDF	0.12 - 0.18

* Exact values can be calculated using GF's online tool or ask your local GF representative.

$$L_B = \sqrt{\frac{3 d_a \Delta L E_{cm}}{\sigma_b}}$$

with:

- d_a = pipe outside diameter (mm)
- ΔL = change in length (mm)
- E_{cm} = average bending creep modulus for $t = 25$ a (N/mm²)
- σ_b = permitted bending stress for $t = 25$ a (N/mm²)



Tip: If the operating temperature is higher than the installation temperature, then the pipe expands. If, on the other hand, the operating temperature is lower than the installation temperature, then the pipe contracts in length.

Remark: Because E_{cm} and σ_b are depending on time, temperature and stress, the calculation of L_B is very difficult. Therefore the following diagrams should be used instead of the formula.

Boundary conditions for using the diagram

For easy determination of the required length of flexible section please use the following diagrams. Please take into account the given boundary conditions.

- Assembly temperature $T_M = 20\text{ °C}$
- T_B Operating temperature
- $\Delta T = T_B - T_M$
- allowable bending stress 15 % of σ_v
- PN 6 .. 16
- Coefficient of friction of the pipe in the loose brackets ≤ 0.5

Information:

The following diagrams show the required flexible sections for straight pipe lengths of 10 m or 70 m. Exceeding the maximally permissible straight pipe distance would lead to buckling of the pipe due to the too large friction in the pipe clamps. Therefore the maximally possible pipe length is to consider depending on the pipe diameter =>above the hatched range.

Example: Determining the required flexible section

Calculating the relevant change in length

The example of an ABS process pipe serves to illustrate the procedure:

Length of piping from the fixed point to the branch point where the change in length is to be taken up:

- $L = 8\text{ m}$.
- Installation temperature: $T_M = 20\text{ °C}$
- Max. working temperature: $T_1 = 35\text{ °C}$
- Min. working temperature: $T_2 = -20\text{ °C}$

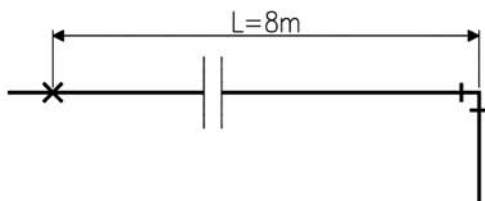

Expansion of the section during heating
 $+\Delta L_1 = L \cdot \Delta T_1 \cdot \alpha = 8 \cdot 15 \cdot 0.10 = 12\text{ mm}$

Contraction during cooling
 $-\Delta L_2 = L \cdot \Delta T_2 \cdot \alpha = 8 \cdot 40 \cdot 0.10 = 32\text{ mm}$

Temperature differences

$$\Delta T_1 = T_1 - T_M = 15\text{ °C}$$

$$\Delta T_2 = T_2 - T_M = -40\text{ °C}$$

Maximum change in temperature chosen

$$\Delta T = 40\text{ °C}$$

Determining the length of the flexible section for PVC-U

The values needed to determine the necessary length are:

- The maximum change in temperature from the 0-position (ie. from the position in which the pipe was installed). But remember that the pipe could just as well contract as expand,
- The pipe diameter d
- The length of the pipe section L

With these values the required length of the flexible section can be read off from the diagram for PVC-U.

Supposing that a PVC-U pipe with $d = 50\text{mm}$ is installed, the maximum change in temperature being $\Delta T = 40^\circ\text{C}$, the required length of the flexible section is seen directly from the diagram to be $L_B = 1300\text{mm}$.

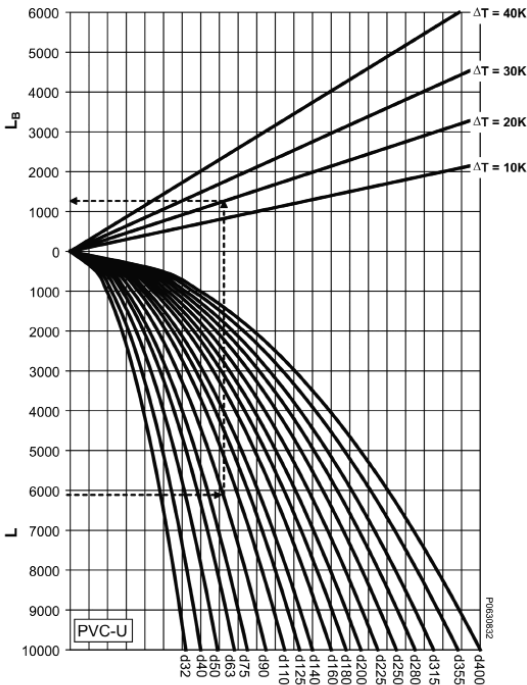

L Length of the pipe section in mm
 L_B Required length of flexible section in mm

The diagram can be used also the other way around, if a maximum flexible section caused by the building construction is given. The the maximum straight length of the pipe can be determined.

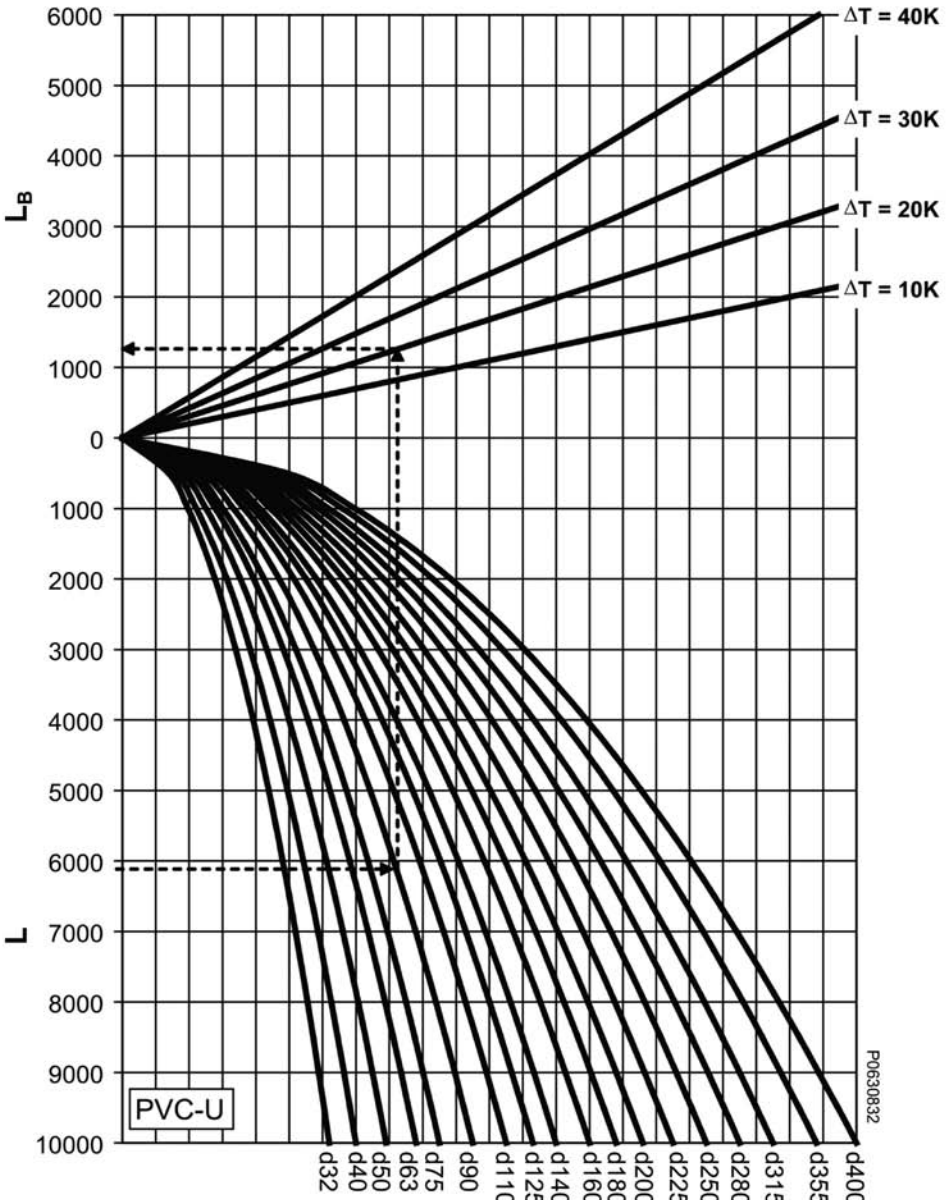

L Length of the pipe section in mm
 L_B Required length of flexible section in mm

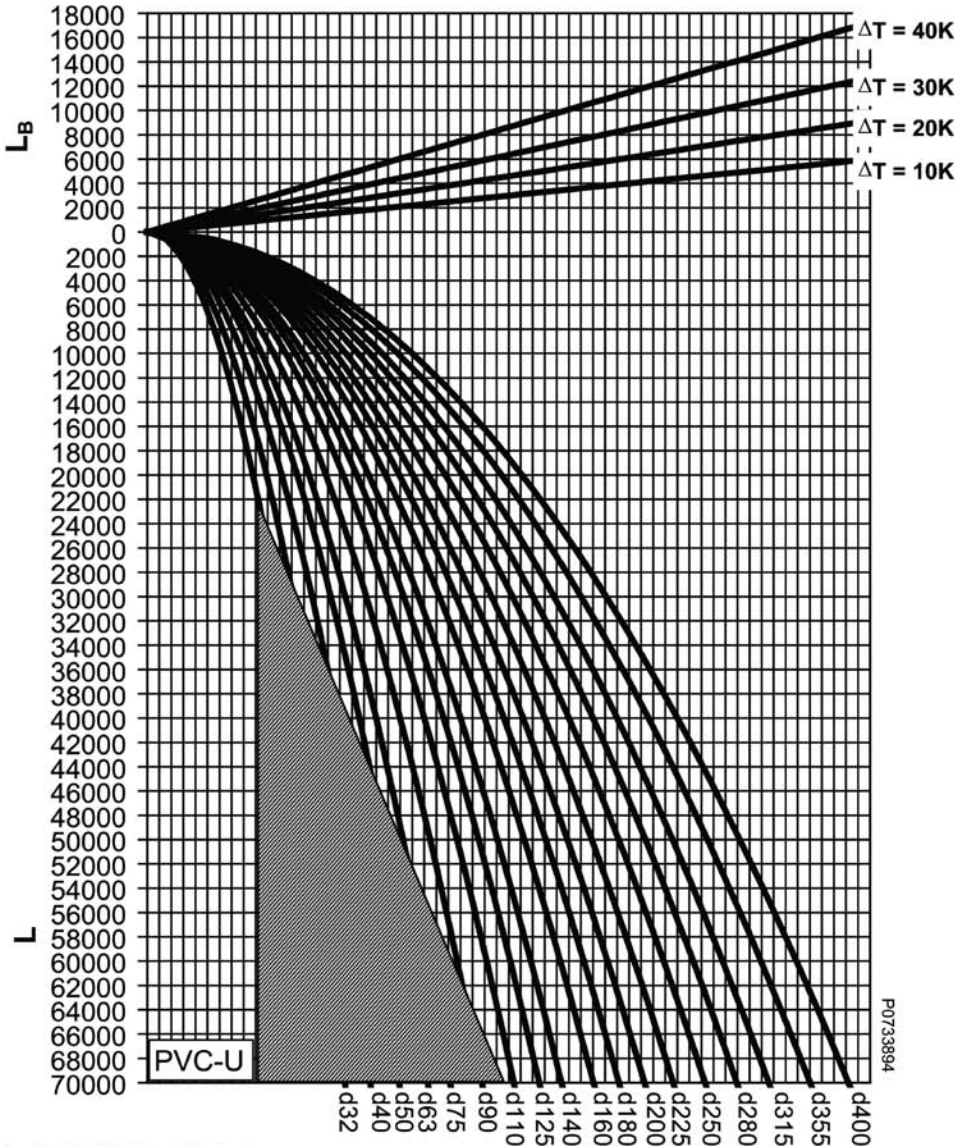

P0733894

L Length of the pipe section in mm

L_B Required length of flexible section in mm

Remark: Please observe the explanations to the hatched area in the clause boundary conditions

Installation of metric industrial piping systems

Recommendations for installation

Length changes in pipe sections should always be accommodated through the arrangement of fixed brackets. The following examples show how the changes can be distributed in pipe sections by suitable positioning of fixed brackets.

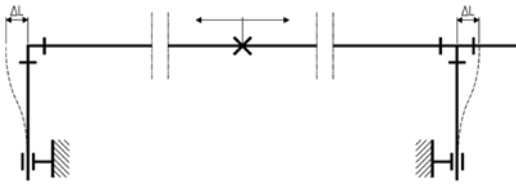

not recommended

recommended

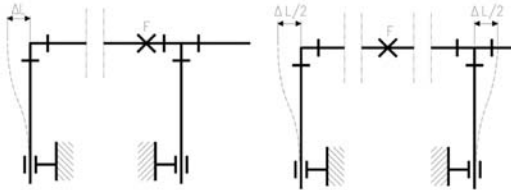

Expansion loops can be installed to take up changes in length when flexible sections cannot be included at a change in direction or branch in the pipeline or if substantial changes in the length of a straight section need to be taken up. In such a case the compensation for changes in length is distributed over two flexible sections.

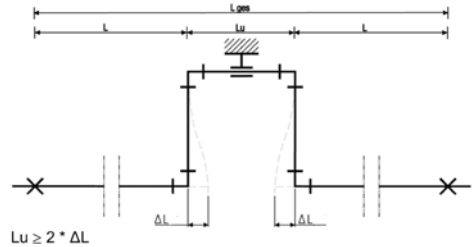

$$L_u \geq 2 * \Delta L$$

NOTICE

Bending load at flexible sections

Caused by the bending load leakages can occur at mechanical joints.

- Within the range of flexible sections and/or expansion loops no screw connections or flange connections shall be used.

Pre-stress

Length changes in pipe sections should always be accommodated through the arrangement of fixed brackets.

The following examples show how the changes can be distributed in pipe sections by suitable positioning of fixed brackets.

Installation data:	L = 10m d = 50mm
Installation temperature:	15 °C
Max. operating temperature:	40 °C
Material:	ABS

a) Change in length

$$+\Delta L = L * \Delta T * \alpha_{ABS} = 10 * 25 * 0.10 = 25 \text{ mm}$$

b) A flexible section to take up a change in length of $\Delta L = 25 \text{ mm}$ needs to be $L_b =$ approx. 1150 mm long according to the diagram.

c) If the flexible section is pre-stressed to $\Delta L/2$ then the required length of the flexible section is reduced to about 800 mm. The variation length from the 0 position is then $\pm \Delta L/2 = 25/2 = 12.5 \text{ mm}$.

Pre-stressing the flexible section makes it possible to reduce its required length in installations where space is restricted. Pre-stressing also reduces the bending of the flexible section in service, improving the appearance of the pipeline.

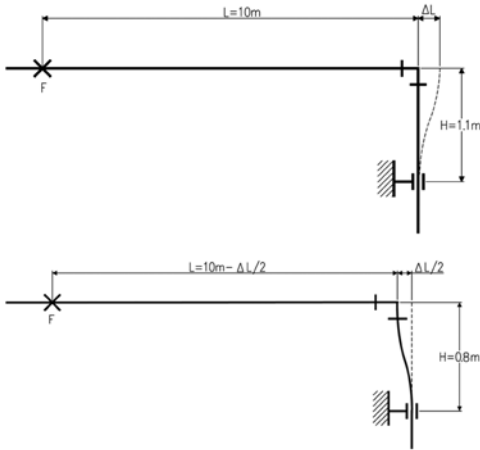

Installing compensators

The low modulus of elasticity means that the reaction force of plastic pipes to thermal changes is low compared to metal pipes. This makes normal compensators designed for use with metal pipes unsuitable because of their high inherent resistance. Only freely moving compensators may be used in plastic pipe systems, i.e. those with a low resistance. The following compensators may be considered: rubber compensators, PTFE corrugated compensators or suitably selected metal multi-disc compensators.

Carefully placed fixed points should be used when fitting compensators for the regulation of the pipe in order to ensure their unhindered operation. The installation temperature provides the basis for the calculations to ensure this.



Tip: When using compensators, additional longitudinal forces are implemented into the pipeline. These forces have to be carried by guiding the pipeline. For example, threaded rods are not suitable. To estimate the lateral forces it can be assumed that they can reach about 15 % of the axial forces. Please contact the manufactures of compensators for further support designing such pipelines.

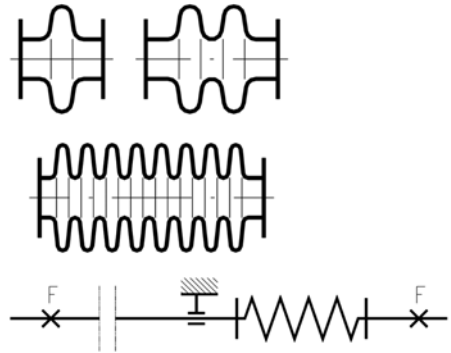

Installing Valves

Valves should be secured as directly as possible, so that the actuation forces are transmitted directly and not via the pipeline. Valve brackets or valves from GF with an integrated fastening device are used to securely fasten plastic valves. These valve brackets are also used to bear the loads of the valve and filling weight of the pipeline. Any changes in length which arise can be prevented with the appropriate fixed points before or after the valve. You will find more information under the respective valve types.

Installing pipework under plaster or embedding it in concrete

Installing Valves

Installing pipework under plaster or embedding it in concrete

Padded pipework

Where pipework is installed under plaster or embedded into concrete, the flexible sections at bends and branches must be padded for the calculated distance H, as also must any branches and elbows included in the affected section. Use only flexible materials as padding, such as glass wool, mineral wool, foam or similar.

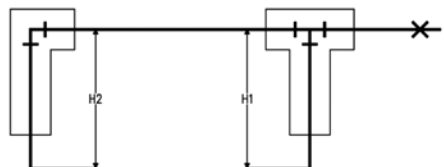

Unpadded pipework

Unpadded pipes can also be plastered or concreted in directly. Since the axial stress arising from internal pressure is half as great as the circumferential stress, pipelines can support limited additional axial stress without becoming overloaded. In such cases the level of stress expected must be calculated. The same is true of any section of pipe between two fixed points where no allowance has been made for changes in length. The load at the fixed points must be calculated and considered when planning the fixed points. The distance between pipe brackets in such cases may have to be reduced from the normal values in order to prevent bowing in the pipeline.

Care must be taken to avoid creating cavities when plastering or concreting in the pipeline, because under unfavourable conditions these can become areas of stress concentration. A rich plaster mixture (1 : 3 to 1 :4) should be used to allow the forces arising from temperature variations to be transmitted away without causing the plaster to crack.

Installation of metric industrial piping systems

Pipe bracket spacing and support of pipelines

General

Pipe support for plastics pipes

Plastic pipe systems should be installed using supports designed for use with plastics and should then be installed taking care not to damage or over stress the pipe.

Arranging Loose Brackets

What is a loose pipe bracket?

A loose pipe bracket is a bracket which allows axial movement of the pipe, to allow stress free compensation of temperature changes and compensation of any other operating condition changes

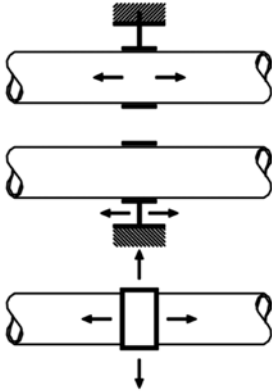

The inner diameter of the bracket should be larger than the outside diameter of the pipe to allow free movement of the pipe. The inner edges of the brackets should be free from any sharp contours which could damage the plastic. If the brackets' inside diameter is not larger than the pipe then the bracket should not be fully tightened, thus allowing the pipe to move.

Another method is to use brackets with spacers which also avoids clamping the bracket on the pipe.

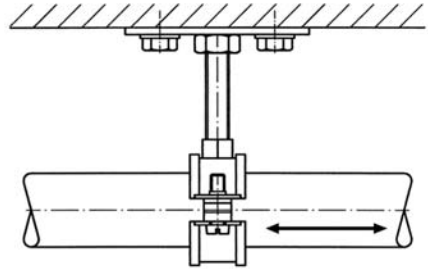

Spacer to avoid clamping

Axial movement of the pipeline must not be prevented by fittings placed next to pipe brackets or by any other component affecting the diameter of the pipe. Sliding brackets and hanging brackets permit the pipe to move in different directions. Attaching a sliding block to the base of the pipe bracket permits free movement of the pipe along a flat supporting surface. Sliding and hanging brackets are needed in situations where the pipeline changes direction and free movement of the pipe must be allowed.

Arranging fixed points

What is a fixed point?

A fixed pipe bracket is a bracket which prevents the pipe from moving in any direction. The aim of which is to control system stresses caused by temperature changes.

NOTICE

Construction of fix point

This should not be done by simply clamping the bracket onto the outside of the pipe! This can cause deformation and physical damage to the pipe, damage that sometimes only later becomes visible.

- It should be done either by using pipe brackets located between two fittings or a double bracket must be used.(double-sided fixed point).
- Placing a pipe bracket immediately adjacent to a fitting restricts movement due to changes in length to one direction (one-sided fixed point).



one-sided fixed point

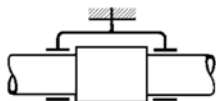

double-sided fixed point

Starting from the dimension d90 the KLIP-IT brackets must be installed standing, like shown in the assembly examples. The support distances given in the following, specified for the KLIP-IT tubing clamps, apply only to this mounting method.

Information:

Pipe brackets must be robust and mounted firmly to be able to take up the forces arising from changes in length in the pipeline. Hanging brackets or KLIP-IT pipe brackets are unsuitable for use as fixed points.

KLIP-IT pipe brackets

These robust plastic pipe brackets can be used not only under rigorous operating conditions, but also where the pipework is subject to aggressive media or atmospheric conditions. They may be used for all materials of pipes. Don't use KLIP-IT pipe brackets as fixed points!



d 16 to d32



d 40 to d 160



d 90 to d 400

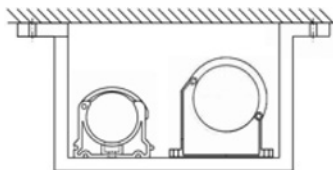
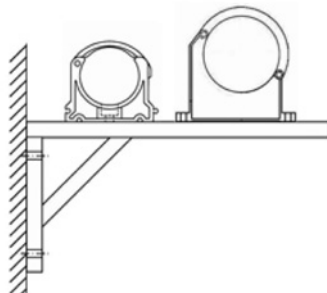
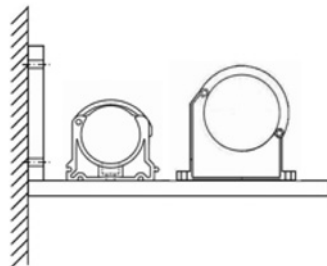

Installation of metric industrial piping systems

Pipe bracket spacing and support of pipelines

Pipe bracket spacing for PVC pipes

PVC-U pipes with liquids with a density of 1 g/cm³

d	DN	Pipe bracket intervals L for SDR21 / S 10 / PN10 pipes in mm at pipe wall temperature:				
		≤20 °C	30 °C	40 °C	50 °C	60 °C
mm	inch					
16	3/8	950	900	850	750	600
20	1/2	1100	1050	1000	900	700
25	3/4	1200	1150	1050	950	750
32	1	1350	1300	1250	1100	900
40	1 1/4	1450	1400	1350	1250	1000
50	1 1/2	1600	1550	1500	1400	1150
63	2	1800	1750	1700	1550	1300
75	2 1/2	2000	1900	1850	1700	1450
90	3	2200	2100	2000	1850	1550
110	4	2400	2300	2250	2050	1750
125	-	2550	2450	2400	2200	1850
140	5	2700	2600	2500	2300	1950
160	6	2900	2800	2700	2500	2100
180	-	3100	2950	2850	2650	2200
200	-	3250	3150	3000	2800	2350
225	8	3450	3300	3200	2950	2500
250	-	3650	3500	3350	3100	2600
280	10	3750	3700	3550	3300	2750
315	12	4100	3900	3750	3500	2950
355	14	4300	4200	4000	3700	3100
400	16	4600	4450	4250	3950	3300

Density of the fluid in g/cm ³	Type of fluid	Factor for pipe bracket spacing
1.00	Water	1.00
1.25	Other	0.96
1.50		0.92
1.75		0.88
2.00		0.84
≤ 0.01	Gaseous	1.42 for SDR21 / S8 / PN10 1.30 for SDR13.6 / S6.3 / PN16 1.20 for SDR11 / S5 / PN20

For other SDR / PN multiply the values given in the table with the following factor:

SDR51 / S25 / PN4 with 0.83

SDR34.3 / S16.7 / PN6 with 0.90

SDR13.6 / S 6.3 / PN16 with 1.08

SDR11 / S 5 / PN20 with 1.15

The pipe bracket spacing given in the table may be increased by 30 % in the case of vertical pipe runs, i. e. multiply the values given by 1.3.

PVC-U pipes with fluids of a density other than 1 g/cm³

If the liquid to be transported has a density not equal 1 g/cm³, then the bracket spacing in the table above should be multiplied by the factor given in the following table.

Pipe brackets for cold insulation (MIP)

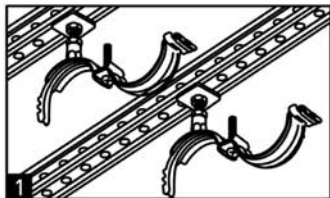

Open handle

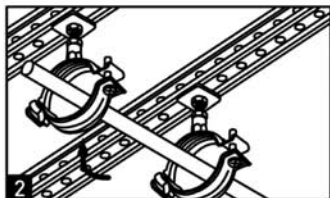

Insert pipe
Close handle with quick-action clamp



Assemble insulation
1. Take off foil
2. Press area of contact

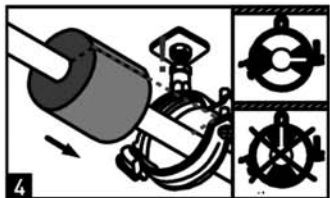

Move insulation into the bracket. Attention!
Make sure the insulator is positioned correctly.

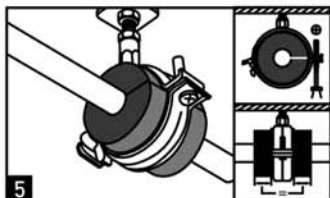

Tighten the screw

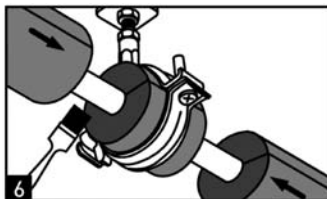

Coat areas of contact with adhesive and bond them

Using the tables for pipe bracket spacing

Plastic pipelines need to be supported at certain intervals depending on several factors: the material, the average pipe wall temperature, the density of the medium transported and the size and wall thickness of the pipe. Determining the spacing between pipe brackets is based on the permissible deflection of the pipe between consecutive brackets.

Information:

The values given in the tables apply only to pipelines which are freely movable in the axial direction.

Pipelines which are fastened tightly in the axial direction (fixed installations) must be checked for buckling. In most cases, this leads to a reduction of the maximum inner pressure and shorter distances between the support brackets. Furthermore, the forces that act on the fixed points must also be taken into consideration. For assistance, please contact your nearest GF representative.



Joining technology

Solvent cement jointing

Instructions for Tangit solvent cement jointing of PVC-U dimension d6 to d400

General

Solvent cement jointing calls for adequate technical know-how, which can be acquired in the appropriate training courses. Your GF representative will gladly provide you with information about training possibilities.



Please consider the appropriate recommendations in the chapter "Chemical Resistance" to the use of Tangit and/or Dytex.

Dimensions and tolerances

The dimensions of GF pipes, fittings and valves conform generally to the various national standards as well as to ISO 727-1 concerning dimensions of sockets. Our fittings and valves can be used with any PVC-U pipes whose outside diameter tolerance conforms to ISO 11922-1.

According to ISO 727-1 the minimal cement lengths are as shown in the table:

Pipe outside diameter / Socket inside diameter d (mm)	Minimal cement length L (mm)
6	12.0
8	12.0
10	12.0
12	12.0
16	14.0
20	16.0
25	18.5
32	22.0
40	26.0
50	31.0
63	37.5
75	43.5
90	51.0
110	61.0
125	68.5
140	76.0
160	86.0
200	106.0
225	118.5
250	131.0
280	146.0
315	163.5
350	183.5
400	206.0

Recommendation for solvent cement jointing of PVC-U fittings of dimensions 250 - 400 mm

PVC-U solvent cement fittings d250 to d280 from GF are designed and tested for a nominal pressure of PN10 (10 bar). The dimensions d315 to d400 are designed and tested for a nominal pressure of PN6 (6 bar).

Our experience and tests reveal that pipes above d315 can be slightly oval, which can produce a heightened cementing gap. GF therefore recommends that pipes from dimensions d315 should be operated at max. 6 bar working pressure.

Please also note the special remarks for dimensions 250 - 400 in the following jointing instructions.

Tools and equipment

Pipe cutter Type KRA	d10 - 63 d50 - 110 d110 - 160	790 109 001 790 109 002 790 109 003
Pipe cutter type KS 355 Pipe cutter type KS 1600	230 V / 50 - 60 Hz	790 202 001 790 109 600
Chamfering tool	d16-75 d32-200	799 495 145 799 495 146
Cleaner	1 litre tin	799 298 010
Tangit PVC-U solvent cement	0.125 kg tin 0.25 kg tin 0.50 kg tin 1.0 kg tin	799 298 000 799 298 001 799 298 002 799 298 003

Brush sizes		
Pipe outside diameter in mm	Brush	
6-10	Round brush ø4 mm	799 299 001
12-32	Round brush ø8 mm	799 299 002
40-63	Flat brush 1" 25 x 3 mm	799 299 003
75-225	Flat brush 2" 50 x 5 mm	799 299 004
250-400	Flat brush 3" 75 x 6 mm	799 299 005
Tin lid		799 298 028
White absorbent paper	commercially available	
Solvent resistant protecting gloves	commercially available	



Cutting the pipe to length



Chamfering the pipe



Solvent cementing equipment

PVC-U Tangit and cleaner: Amounts required

Pipe diameter d (mm)	PVC-U Tangit amount per 100 joints (kg)	PVC-U Tangit number of joints per tin 1 kg
16	0.4	250
20	0.5	200
25	0.6	166
32	0.8	125
40	1.1	91
50	1.5	72
63	1.7	59
75	2.2	45
90	4.0	25
110	8.0	12
140	13.0	7
160	19.0	5
200	24.0	4
225	26.0	3.5
250	31.0	3
280	38.0	2.5
315	52.0	2
355	62.0	1.6
400	75.0	1.2

Pipe diameter d (mm)	Tangit cleaner amount per 100 joints (litre)	Tangit cleaner number of joints per tin 1 litre
16	0.2	500
20	0.3	333
25	0.4	250
32	0.5	200
40	0.7	143
50	0.9	111
63	1.1	91
75	1.3	77
90	1.4	71
110	1.7	59
140	2.1	48
160	2.5	40
200	3.5	29
225	4.5	22
250	5.5	18
280	6.5	15
315	10.2	10
355	14.0	7
400	18.0	5

Note: The quantities specified above are to be understood as practice-orientated maximum values. In principle the quantities depend on gap dimensions, temperatures, working technique.

Preparations

The pipe must be cut off at right angles. Remove the inside edges and chamfer the outside ones as illustrated in the sketch. Only then is an optimal solvent cemented joint possible.

Important: Well-chamfered pipe ends prevent the layer of cement from being removed as the pipe is inserted into the fitting.

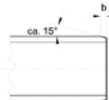

Pipe outside diameter mm	b
6 - 16 mm	1 - 2 mm
20 - 50 mm	2 - 3 mm
63 - 225 mm	3 - 6 mm
250 - 400 mm	6 - 8 mm



Marking the jointing length

Wipe the outside of the pipe and the inside of the socket with a clean cloth to remove obvious dirt. Marking the jointing length on the pipe end makes it possible to check afterwards whether the pipe has been inserted to the full extent of the socket.

Note: If the outside diameter of the pipe and the inside diameter of the socket are at opposite extremes of their tolerances, then the pipe cannot be inserted dry into the fitting socket. This will only become possible once the cement has been applied.



Checking the cement

The Tangit PVC-U cement is supplied ready for use. Stir thoroughly before using! Cement of the correct consistency will run evenly from a wooden spatula held at a slant. Cement which no longer runs smoothly is unusable. The cement must not be thinned.

For more information please consult the safety datasheets under the following link:
<https://www.sdb.henkel.de/index.cfm>

Cement and cleaner should be stored in a cool, dry place (5–35 °C)! Under these conditions the cement and cleaner are durable for 24 months starting from the date of filling (imprinted on the tin).

Cementing

Clean the outside of the pipe end and the inside of the socket **thoroughly** with Tangit cleaner and absorbent paper. Use a fresh piece of paper for each component. Remove any condensation which may have formed on the parts.

Important: Pipe end and fitting socket must be dry and free from grease and dirt and must not be touched after cleaning.



Cleaning the pipe and socket

PVC-U pipes may have a waxy surface. To ensure proper jointing in such a case the cleaning process must be repeated until the pipe surface becomes matt to the eye.

For the range of dimensions d250 - 400, mechanical machining of the pipe surface can be necessary in individual cases. An indication of inadequate jointing quality, which could be expected, is absence of or insufficient adhesion of the jointing parts following fine cleaning ("finger-nail check"). The jointing surfaces should then be roughened evenly with emery cloth of grain 80 or finer, observing the max. permitted gap.

PVC-U pipes should be cemented at temperatures between 5 °C and 40 °C. Take the following protective measures if the temperatures deviate from the above:

At lower temperatures, condensation or frost which may have formed must be removed, e. g. with warm air. Cement and cleaner should be stored at room temperature.

Avoid uneven overheating (→ shorten the opening time) when cementing at higher temperatures by protecting the jointing area from direct sunlight.

The quick curing time of the cement necessitates that the joint is made within the opening time after application of the cement has started. The opening time of the PVC-U cement varies with the ambient temperature and the thickness of the cement applied:

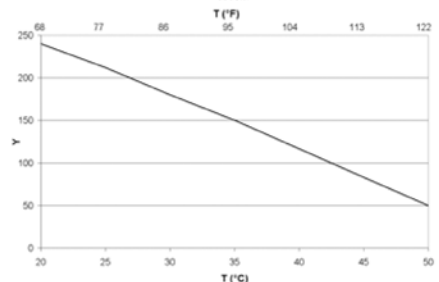

T Temperature in °C, °F

Y Opening time [sec]

Remark: When using Tangit Express the opening time is shortened at 20 °C to 1 minute and at 40 °C to 30 seconds. Therefore the maximum dimension is limited to 110 mm.



Applying the cement

To ensure that both jointing surfaces are completely covered with a smooth, even layer of cement, the brush should be generously loaded with cement.

Range of dimensions up to d75

Apply cement

The cement joints can be produced by one person.

Jointing

After the cement has been applied, insert the pipe to the full depth of the socket immediately without twisting and bring them into the correct alignment. Ensure that the outlet of the fitting is in the correct position. Hold them briefly in this position to allow the cement to set.

Waiting time between cementing

Wait at least 5 minutes before the next joint, extend the waiting time at temperatures under 10 °C to 15 minutes.

Range of dimensions d90 to d225

Apply cement

The fitting socket and end of pipe should be coated with cement simultaneously by two persons, otherwise the opening time of the cement cannot be observed.

Jointing

After the cement has been applied, insert the pipe to the full depth of the socket immediately without twisting and bring them into the correct alignment. Ensure that the outlet of the fitting is in the correct position. Hold them briefly in this position to allow the cement to set.

Waiting time between cementing

Wait at least 5 minutes before the next joint, extend the waiting time at temperatures under 10 °C to 15 minutes.

Range of dimensions d250 to d400

Apply cement

Deviating from the usual method of application, pour the cement directly from the tin onto the middle of the cementing surface and distribute first radially and then axially all over with a flat brush. Make sure that the cement layer is consistent and covers the entire surface as appropriate for the larger tolerances.

Apply a thinner layer of Tangit in the fitting than on the pipe ends. The cementing of pipe work in this range of dimensions should be carried out by at least 2 persons. The minimum thickness of the cement layer for fittings is 1 mm, apply more generously on the pipe ends.

After applying the cement, the pipe and fitting should be slowly pushed together to the stop or the mark without twisting by 3-4 persons and aligned. Ensure that the outlet end of the fitting is in the correct position. Hold the joint in this position for 1 minute.

Waiting time between cementing

A waiting time of 15 minutes should be observed before further jointing; this time should be increased to 30 minutes at temperatures below 10 °C.



Replace the lid of the cement tin during work breaks

Remove any surplus cement immediately, using absorbent paper.

A bead of excess solvent cement around the complete external circumference of the joint and a slightly smaller bead again around the complete internal circumference show that the joint has been performed correctly.

After use, clean the brush of excess cement with dry absorbent paper and then clean thoroughly using TANGIT cleaner. Brushes must be dry before being re-used (shake out).

Replace the lid of the cement tin after use to prevent the solvent evaporating. Using the conical lid allows leaving the brush in the cement tin during breaks.



The pipe trench is not a rubbish tip

Both solvent cement and cleaner dissolve PVC-U. Pipes and fittings must therefore not be laid on or allowed to come into contact with spilled cement or paper containing cement residues.

Do not close off cement pipelines during the drying process. This is particularly important at temperatures below + 5 °C, when there is otherwise a danger of damaging the material.

After the drying process (see waiting times in the following table) the pipelines can be filled. It is recommended to flush the pipeline before use, and leave it filled with water if it is not directly used. Do not use compressed air for flushing.

Drying period and pressure testing

The drying period of the cement before application of the test or working pressure depends on the drying temperature, the dimension and the fit conditions.

The waiting times required between completing the last joint and the pressure test are specified in the following table.

If the pipe is only subjected to the operating pressure, e. g. after adaptation or repair work, the following rule of thumb for the drying waiting time applies:

1 hour waiting time per bar operating pressure.

For temperatures above 20 °C the test pressure must be reduced according to the requirements given in the chapter "Final testing and commissioning".

Remark: When using Tangit Express (only up to d110) the waiting time is shortened to 12 hours, or 1/4-hour waiting time per bar operating pressure.

Dimension	Nominal pressure (PN) of fitting 20 °C, water	Max. working pressure 20 °C, water
up to d225	PN10 or PN16	10 or 16 bar
d250	PN10	10 bar
d280	PN10	10 bar
d315	PN6	6 bar
d350	PN6	6 bar
d400	PN6	6 bar

Dimension	Max. test pressure 20 °C, water	Waiting time after last cementing until test
up to d225	15 or 21 bar	15 or 24 h
d250	15 bar	24 h
d280	15 bar	
d315	9 bar	
d350	9 bar	
d400	9 bar	

Protect pipes and fittings from spilled solvent cement, cleaner and absorbent paper which has been used to wipe off cement. Do not dispose of surplus solvent cement or cleaner in drainage systems.

The use of protective gloves is recommended to avoid contact with skin. If the cement or the cleaner get in contact with eyes, rinse immediately with water. Consult a doctor! Immediately change clothes that have solvent cement on them.

Always obey the safety regulations issued by the authorities responsible.



Adequate ventilation of the workplace



No open flames when cementing. No smoking.

Jointing technology

Solvent cement jointing

Instructions for Dytex solvent cement jointing of PVC-U and PVC-C dimension d12 to d140

General

Dytex solvent cement combined with Dytex solvent /cleaner is a special cementing system for PVC-U / PVC-C piping systems which are exposed to the effects of highly aggressive chemicals, such as concentrated, inorganic acids. For all media not mentioned below or media in lower concentrations, Tangit solvent cement should be used. Because Dytex is not gap-filling, a special cement jointing procedure is required and is described in the following. Dytex solvent cement jointing calls for adequate technical know-how, which can be acquired in the appropriate training courses.

Your GF representative will gladly provide you with information about training possibilities. The dimensions of GF pipes, fittings and valves conform generally to the various national standards as well as to ISO 727-1 concerning dimensions of sockets. Our fittings and valves can be used with any PVC-U or PVC-C pipes whose outside diameter tolerance conforms to ISO 11922-1. According to ISO 727-1 the following minimal cement lengths apply:

Pipe outside diameter - Socket inside diameter d (mm)	Minimal cement length L (mm)
12	11.0
16	13.0
20	15.0
25	17.5
32	21.0
40	25.0
50	30.0
63	36.5
75	42.5
90	50.0
110	60.0
125	67.5
140	75.0

The use of Dytex solvent cement is recommended for cement jointing PVC-U or PVC-C in connection with the acids shown in the table.

Due to the effects of these acids on the pipe material, we recommend using pipes with a pressure rating PN16. For the expected lifetime and strength, please contact your GF representative. Attention! Usually the allowable pressure must be decreased by one pressure rating (thus PN16 to PN10). When using Dytex in PVC-C piping construction with the below mentioned acids, the pressure and temperature requirements for PVC-U must be adhered to. Please refer to the information on the below mentioned acids in our list of chemical resistance.

Medium	Up to % concentration
Sulphuric acid	≥70 % H ₂ SO ₄ concentration
Chromic- sulphuric acid mixture	≥70 % H ₂ SO ₄ concentration plus 5 % K ₂ Cr ₂ O ₇ / Na ₂ Cr ₂ O ₇
Chromic acid	≥10 % CrO ₃ concentration
Hydrochloric acid	≥25 % HCl concentration
Nitric acid	≥20 % HNO ₃ concentration
Sodium hypochlorite (calcium hypochlorite)	≥6 % NaOCl concentration of active chlorine
Hydrogen peroxide	≥5 % H ₂ O ₂ concentration
Hydrofluoric acid	In every HF concentration

Tools and equipment

Pipe cutter Type KRA	d10 - 63 d50 - 110 d110 - 160	790 109 001 790 109 002 790 109 003
Pipe cutter type KS 355	230 V / 50 - 60 Hz	790 202 001
Chamfering tool	d16-75 d32-200	799 495 145 799 495 146
Dytex solvent and cleaner	0.5 litre tin	799 271 383
Dytex solvent cement	0.5 litre tin	799 271 423
Brush sizes		
Pipe outside diameter in mm	Brush	
6-10	Round brush ø4 mm	799 299 001
12-32	Round brush ø8 mm	799 299 002
40-63	Flat brush 1" 25 x 3 mm	799 299 003
75-140	Flat brush 2" 50 x 5 mm	799 299 004
Tin lid		799 298 028
White absorbent paper	commercially available	
Solvent resistant protecting gloves	commercially available	



Cutting the pipe to length



Chamfering the pipe

Important:

Well-chamfered pipe ends prevent the layer of cement from being removed as the pipe is inserted into the fitting.

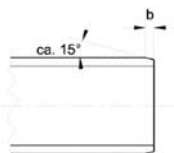

Pipe outside diameter mm	b
6 - 16 mm	1 - 2 mm
20 - 50 mm	2 - 3 mm
63 - 140 mm	3 - 6 mm



Marking the jointing length

Dytex solvent and cleaner: Amounts required

Pipe diameter d (mm)	Dytex cement amount per 100 joints (kg)	Dytex cleaner amount per 100 joints (litre)
16	0.25	0.55
20	0.3	0.65
25	0.4	0.8
32	0.5	1.0
40	0.7	1.2
50	0.9	1.4
63	1.1	1.8
75	1.5	2.3
90	2.1	3.1
110	2.9	4.7
140	4.5	7.9

Note: The quantities specified above are to be understood as practice-orientated maximum values. In principle the quantities depend on gap dimensions, temperatures, working technique.

Preparations

The pipe must be cut off at right angles. Remove the inside edges and chamfer the outside ones as illustrated in the sketch. This is the only way to achieve an optimal solvent cemented joint. Important:

Wipe the outside of the pipe and the inside of the socket with a clean cloth to remove obvious dirt. Marking the jointing length on the pipe end makes it possible to check afterwards whether the pipe has been inserted to the full extent of the socket.

Because Dytex cement is not gap-filling, the fit of the pipe and fitting must be checked in the dry state. If the pipe end can be inserted easily and without resistance to the stop, several applications of cement are necessary.

Dytex solvent cement is supplied ready to use. Stir well before using. Diluting the solvent cement is prohibited. Cement and solvent should be stored in a dry and cool place (5 - 35 °C)! Under these conditions the cement and cleaner are durable for 24 months starting from the date of filling (imprinted on the tin).

For more information please consult the safety datasheets under the following link: <https://www.sdb.henkel.de/index.cfm>

Cementing

Thorough cleaning is done with the Dytex solvent (do not use Tangit cleaner!). Soak a white, absorbent, lint-free paper with Dytex solvent and thoroughly clean the dry surfaces which are to be cemented. Use a new sheet of absorbent paper for each cleaning. Then brush Dytex solvent onto the surfaces to be cemented (pipe ends on the outside, fitting on the inside) until the surface clearly begins to dissolve (becomes sticky). Apply Dytex cement to the dissolved surfaces with a brush in the axial direction and let dry for at least 30 seconds. Repeat this process as indicated in the following table.

Cement gap (diameter difference) of more than 0.4 mm are not permitted! Pipes / fittings from the dimension 110 must be measured to determine the permissible gap.

d up to 16 mm	gap = ± 0.0 mm	max. 2 x both sides
d 16 - 25 mm	gap = + 0.0 mm	max. 3 x both sides
d 32 - 40 mm	gap = + 0.1 mm	max. 4 x both sides
d 50 - 63 mm	gap = + 0.2 mm	max. 6 x both sides
d 75 - 90 mm	gap = + 0.3 mm	max. 8 x both sides
d 110 - 140 mm	gap = + 0.4 mm	max. 10 x both sides

Cement applications in relation to gap (diameter difference)



Remark: If there are smaller gaps than shown in the table, the amount of cement applications can be reduced.

After the final application of cement, coat both surfaces again with the Dytex solvent until they are once again sticky, then insert the parts immediately to the full depth of the fitting, without twisting/tilting and hold for a few seconds. Make sure that the fitting outlet is in the right position. When inserting, you must feel some resistance. The solvent cement bead that forms must be complete and consistent. Excess cement is wiped off immediately. Because the solvent cement bonds quickly, the parts must be joined within max. 1 minute of applying the final coat of Dytex solvent. At temperatures above 25 °C this time frame is reduced to under 1 minute. Due to the short open assembly time of 1 minute, the use of Dytex is limited to a pipe diameter of 140 mm.

The waiting time between the individual work steps (=next cement joint) depends on the size of the gap.

Cement gap less than 0.2 mm	Cement gap greater than 0.2 to 0.4 mm
Waiting time 10 - 15 minutes	Waiting time 30 minutes At temperatures under 10 °C the waiting time extends to 45 minutes

The cementing should be done at temperatures between 5 °C and 40 °C. If there are deviations, please observe the following safety measures:

At temperatures near the freezing point, any condensation or thaw must be removed, e.g. with warm air. The cement and the solvent should be kept beforehand at room temperature. The finished joint must be kept at approx. 25 °C for another 15-30 minutes.

At higher temperatures, protect the jointing area from direct sunlight as the components could heat up too much.

Up to d63 mm, the cement joints can be manufactured by one person alone. From d75 mm one person should apply the cement to the fitting socket while another coats the pipe end, otherwise it is not possible to maintain the open assembly time of max. 1 minute.

Remove any thick cement residue on the brush with a dry absorbent paper and then rinse the brush with the solvent. Before using the cleaned brushes again, they must be dry to touch (shake out).

To prevent the solvent from evaporating (cement dries up), the cement tin should be kept closed during work breaks. A lid that allows keeping the brush in the tin can be used.



The pipe trench is not a rubbish tip

Since Dytex cement and solvent are etching, pipes or fittings may not be placed on spilled cement or cement residue left on the paper or come into contact with them in any way. Do not close off cemented pipelines during the drying process. This is particularly important at temperatures below + 5 °C, when there is otherwise a danger of damaging the material.

Drying period and pressure testing

After a drying period of approx. 48 hours at room temperature, the final strength of the joint is achieved. At lower ambient temperatures, the bonding takes longer. The pipeline may only be filled and the pressure test may only be done at the earliest 48 hours after the last cementing.

For temperatures above 20 °C the test pressure must be reduced according to the requirements given in the chapter "final testing and commissioning".

Safety precautions

Dytex cement and Dytex solvent contain highly volatile solvents. Make sure there is adequate ventilation or exhaust fans in closed rooms. Solvent vapours are heavier than air. The off-take must therefore be on the floor or under the workbench for example. The paper used to clean the parts and to remove the cement must be deposited in closed containers to reduce the amount of solvent vapours in the air.

The cement and the solvent are flammable. Make sure there are no open flames before starting to work. Shut off any electrical equipment that is not designed to be explosion-proof, electric ovens, etc. Do not smoke! Stop all fusion work. Also study the instructions of the cement manufacturer (e.g. on the tin and in the leaflets supplied).

Protect pipes and fittings from spilled cement, solvent and paper that has been used to wipe the cement from the parts. Do not pour cement or solvent no longer required into the sewer pipes.

We recommend using protective gloves to avoid contact with the cement and the solvent. In case of contact with eyes, rinse thoroughly with water. Seek medical advice!

Replace clothing contaminated with the cement immediately.

Observe the respective accident prevention guidelines.



Adequate ventilation of the workplace



No open flames when cementing. No smoking.

Jointing technology

Solvent cement jointing

Retrofit of adapter fittings into an existing ABS, PVC-U or PVC-C pipeline

Existing situation:

Occasionally there is the need to install measuring-devices, venting devices or similar into an existing piping system without using additional installation fittings.

Solution:

At the section of the piping system with greatest wall thickness (in the middle of the joint) a hole is drilled for the spigot of the adapter fitting. Then a suitable adapter fitting is solvent cemented into the hole which acts as socket.

Installation steps in detail:

1. The hole is drilled into a drained pipe section.
2. The hole is drilled at a right angle to the pipe axis.
3. The hole diameters and tolerances given in the attached table correspond to socket dimensions according to ISO 727-1 and are to be observed.
4. The dimension X in the attached table indicates the distance from the entrance of the socket to the middle of the hole to be drilled in order to place it in the middle of the joint.
5. Use a suitable deburring tool to deburr the edges of hole.
6. Shavings should be removed from the pipe.
7. Allowed combinations of pipe and adapter fitting are indicated in the attached table with yes. The selection is such that the spigot of the adapter fitting does not reach into the medium filled pipe for more than 1 mm as well as fully covering the hole drilled into the joint.
8. The spigot is solvent cemented into the drilled hole according to the instructions for solvent cement jointing given in our Planning Fundamentals.
9. Observe the waiting times before refilling and applying pressure to the system.
When correctly installed the above joint is good for PN10 at 20 °C with water as the medium.

Allowed combinations of pipe and adapter dimensions

ABS PN10		Wall thickness, e	Adapter dimensions			
pipe diameter		S8, SDR17	20	25	32	40
75	x	4.5	Yes	Yes	No	No
90	x	5.4	Yes	Yes	No	No
110	x	6.6	Yes	Yes	No	No
125	x	7.4	Yes	Yes	No	No
140	x	8.3	Yes	Yes	No	No
160	x	9.5	Yes	Yes	No	No
180	x	10.7	Yes	Yes	Yes	No
200	x	11.9	Yes	Yes	Yes	No
225	x	13.4	Yes	Yes	Yes	Yes

ABS PN6		Wall thickness, e	Adapter dimensions			
pipe diameter		S12.5, SDR26	20	25	32	40
250	x	9.6	No	Yes	Yes	No
280	x	10.7	No	Yes	Yes	Yes
315	x	12.1	No	No	Yes	Yes

PVC-U PN10		Wall thickness, e	Adapter dimensions			
pipe diameter		S10, SDR21	20	25	32	40
125	x	6.0	No	No	No	No
140	x	6.7	Yes	No	No	No
160	x	7.7	Yes	Yes	No	No
180	x	8.6	Yes	Yes	No	No
200	x	9.6	Yes	Yes	Yes	No
225	x	10.8	Yes	Yes	Yes	Yes
250	x	11.9	No	Yes	Yes	Yes
280	x	13.4	No	Yes	Yes	Yes
315	x	15.0	No	No	Yes	Yes
400	x	19.1	No	No	Yes	Yes

PVC-U PN16		Wall thickness, e	Adapter dimensions			
pipe diameter		S6.3, SDR13.6	20	25	32	40
125	x	9.2	Yes	No	No	No
140	x	10.3	Yes	Yes	No	No
160	x	11.8	Yes	Yes	Yes	No

Dimensions of hole to be drilled

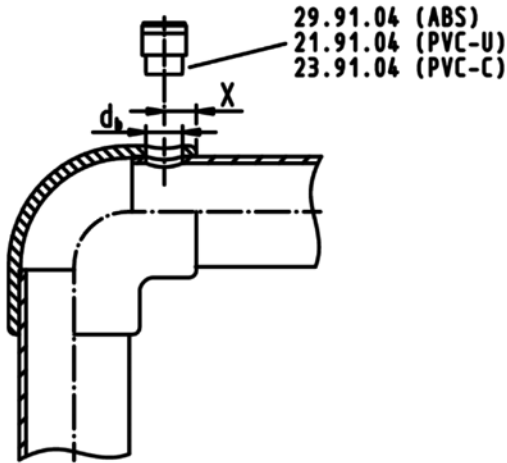

Adapter dimension	Hole diameter, d_b in mm
20	20.2
25	25.2
32	32.2
40	40.2
Tolerance	± 0.1 mm

Pipe dimension	Drill position X in mm
75	22
90	26
110	31
125	34
140	38
160	43
180	48
200	53
225	59
250	66
280	73
315	82
400	103
Tolerance	± 1 mm

Installation of metric industrial piping systems

Internal pressure test and leak test

Internal pressure test with water or a similar incompressible test fluid

General

The internal pressure test is done when installation work has been completed and necessitates an operational pipeline or operational test sections. The test pressure load should furnish experimental proof of operational safety. The test pressure is not based on the working pressure, but rather on the internal pressure load capacity, derived from the pipe wall thickness.

Supplement 2 of DVS 2210-1 forms the basis for the following information. This replaces the data in DVS 2210-1 entirely. The modifications became necessary because

- the reference value "nominal pressure (PN)" is being used less and less to determine the test pressure (1.5 x PN, or 1.3 x PN) and is being replaced by SDR,
- a short-term overload or even a reduction in the service life can occur if in the course of the internal pressure test based on the nominal pressure the pipe wall temperature $T_R = 20\text{ °C}$ is exceeded by more than 5 °C.

Test pressures are therefore determined in relation to SDR and the pipe wall temperature. The 100-h value from the long-term behaviour diagram is used for the test clamping.

Test Parameters

The following table indicates recommended methods of testing the internal pressure.

Object	Pre-test	Main test
Test pressure p_p (depends on the pipe wall temperature or the permissible test pressure of the built-in components, see clause "Determining the test pressure")	$\leq p_{p(\text{perm})}$	$\leq 0.85 p_{p(\text{perm})}$
Test duration (depends on the length of the pipeline, respectively the sections)	$L \leq 100\text{ m}$: 3 h $100\text{ m} < L \leq 500\text{ m}$: 6 h	$L \leq 100\text{ m}$: 3 h $100\text{ m} < L \leq 500\text{ m}$: 6 h
Checks during the testing (test pressure and temperature progression should be recorded)	At least 3 checks, distributed over the test duration with restoring the test pressure	At least 2 checks, distributed over the test duration without restoring the test pressure

Pre-test

The pre-test serves to prepare the piping system for the actual test (main test). In the course of pre-testing, a tension-expansion equilibrium in relation to an increase in volume will develop in the piping system. A material-related drop in pressure will occur which will require repeated pumping to restore the test pressure and also frequently a re-tightening of the flange connection screws.

The guidelines for an expansion-related pressure decrease in pipes are:

Material	Pressure drop
PVC-U	0.5 bar/h
PVC-C	0.5 bar/h
ABS	0.6 bar/h
PP	0.8 bar/h
PE	1.2 bar/h
PB	1.4 bar/h
PVDF	0.8 bar/h

Main test

In the context of the main test, a much smaller drop in pressure can be expected at constant pipe wall temperatures so that it is not necessary to pump again. The checks can focus primarily on leak detection at the flange joints and any position changes of the pipe.

Observe if using compensators

If the pipeline to be tested contains compensators, this has an influence on the expected axial forces of the pipeline. Because the test pressure is higher than the working pressure, the axial forces on the fixed points become higher. This has to be taken into account when designing the fixed points.

Observe if using valves

When using a valve at the end of a pipeline (end or final valve), the valve and the pipe end should be closed by a dummy flange or cap. This prevents inadvertent opening of the valve or any pollution of the inside of the valve.

Filling the pipeline

Before starting with the internal pressure test, the following points must be checked:
Was installation done according to the available plans?

- All pressure relief devices and flap traps mounted in the flow direction?
- All end valves shut?
- Valves in front of other devices are shut to protect against pressure.
- Visual inspection of all joints, pumps, measurement devices and tanks.
- Has the waiting period after the last fusion / cementing been observed?

Now the pipeline can be filled from the geodetic lowest point. Special attention should be given to the air vent. If possible, vents should be provided at all the high points of the pipeline and these should be open when filling the system. Flushing velocity should be at least 1 m/sec.

Reference values for the filling volume are given in the following table.

DN	V (l/sec)	DN	V (l/sec)
≤ 80	0.15	250	2.0
100	0.3	300	3.0
150	0.7	400	6.0
200	1.5	500	>9.0

Adequate time should be allowed between filling and testing the pipeline, so that the air contained in the piping system can escape via the vents:
ca. 6 - 12 h, depending on the nominal diameter

Applying the test pressure

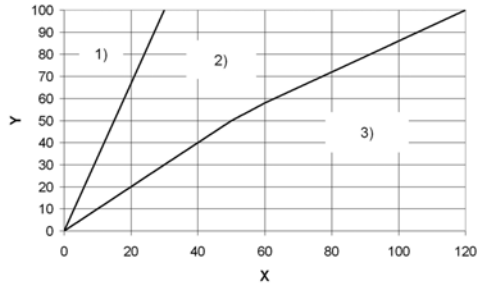

The test pressure is applied according to the diagram.

Here it is important that the pressure increase rate does not cause any water hammer!

Definitions

Y = test pressure in %

X = time for pressure increase in min

1) = pressure increase rate up to DN 100

2) = range of pressure increase rates >DN 100 - 400

3) = reference values for pressure increase rate DN 500 and greater is: 500 / DN [bar/10 min]

Determining the test pressure

The allowable test pressure is calculated according to the following formula:

$$P_{p(\text{perm})} = \frac{1}{\text{SDR}} \frac{20}{S_p A_G} \sigma_{v(T,100h)}$$

with

$\sigma_{v(T,100h)}$ Long-term creep strength for the pipe wall temperature T_R (at $t = 100$ h)

S_p Minimum safety factor for long-term creep strength

A_G Processing or geometrical specific factor that reduces the allowable test pressure

T_R Pipe wall temperature: average value of test medium temperature and pipe surface temperature

NOTICE

Diaphragm valves, types 514-519

Don't overload diaphragm valves!

- If the piping system contains diaphragm valves the maximum allowable test pressure is limited to the nominal pressure.

Material	S _n Minimum safety factor
ABS	1.6
PE80, PE100	1.25
PP-H	1.8
PP-R	1.4
PVC-U, PVC-C	2.5
PVDF	1.4

General

To make things easier, the permissible test pressures can be taken directly from the following diagrams.

Definitions:

P = permissible test pressure in bar

T = pipe wall temperature in °C

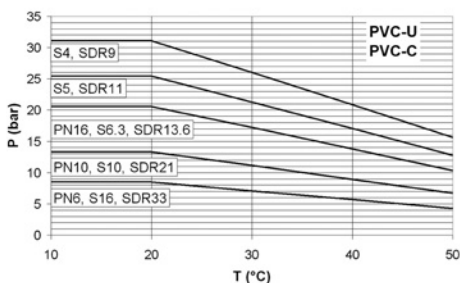
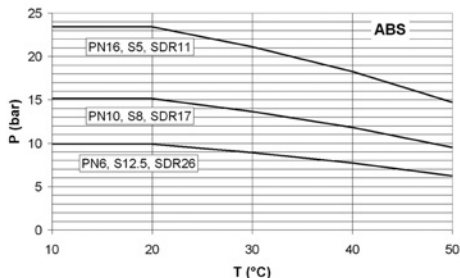
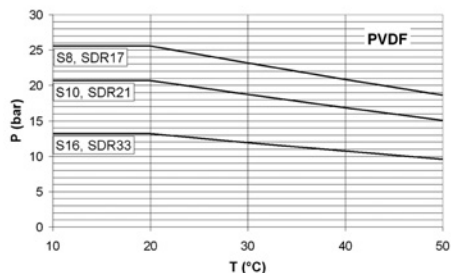
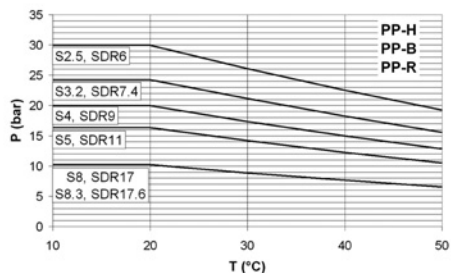
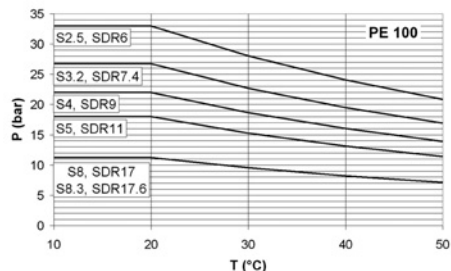
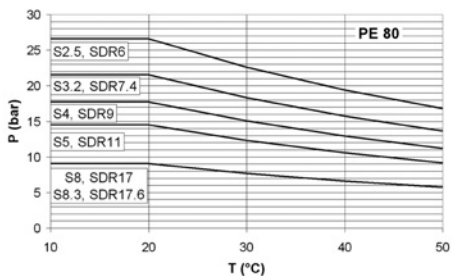

General

- Internal pressure at the absolute low point of the pipeline
- Medium and ambient temperature
- Water volume input
- Water volume output
- Pressure drop rates

Checks during testing

The following measurement values must be recorded consistently during testing:

PVC-U Inch Product Range

(for further details please contact your local Georg Fischer Supplier)

All the below pressure rating are with water at 20°C

Pipe

Class E	15 bar	3/8"-5"
Class D	12 bar	1 1/4"-4"
Class C	9 bar	2"-8"
Class T	12 bar	3/8"-2"
SCH80	15 bar	1/2"-6"
SCH80	9 bar	8"-16"

Fittings

Long Bends	15 bar	1/2"-6"
Short Pattern Bend	9 bar	8"
Elbows 90°	15 bar	3/8"-6"
	9 bar	8"-16"
Tee 90°	15 bar	3/8"-6"
	9 bar	8"-16"
Tee 90° Reduced	15 bar	3/4"-6"
	9 bar	8"-16"
Tee 45°	9 bar	1/2"-2"
	6 bar	2 1/2"-16"
Elbow 45°	15 bar	3/8"-6"
	9 bar	8"-16"
Cross	12 bar	3/4"-2"
	9 bar	2 1/2"
Socket	15 bar	3/8"-6"
	9 bar	8"-16"
Cap	15 bar	3/8"-4"
	9 bar	5"-16"
Flange Adaptors (Serrated, flat)	15 bar	1/2"-6"
	9 bar	8"-10"
	6 bar	12"
Van Stone Type Flanges (Serrated, flat)	9 bar	1/2"-16"
Union (EPDM and FPM)	15 bar	3/8"-2"
	9 bar	2 1/2"-4"
Short Reducing Bushes	15 bar	1/2"-6"
	9 bar	8"-16"
Long Reducing Bushes	15 bar	5"-6"
Reducing Coupling	15 bar	3/4"-6"
	9 bar	8"-16"
Adaptor Sockets (Female Thread x Socket)	15 bar	3/8"-2"
Adaptor Sockets (Female Thread x Nipple)	15 bar	3/8"-2"

PVC-U Inch Product Range

(for further details please contact your local Georg Fischer Supplier)

All the below pressure rating are with water at 20°C

Fittings

Adaptor Bush (Socket x male thread)	15 bar	3/8"-4"
Full Thread Fittings (Thread x Thread)	10 bar	3/8"-2"
Adaptor Unions (Brass, ABS, Stainless Steel Malleable Iron)	15 bar	1/2"-3"
Accessories (Loose flanges, Sets, Pipe Brackets etc.)		Various

Hand-operated and actuated valves

Ball Valve, Type 546	15 bar	3/8"-4" (EPDM, FPM)
3 way Ball Valve, Type 543 FPM)	10 bar	3/8"-2" (EPDM,
2 way Ball Valve, Type 375	15 bar 10 bar	3/8"-2" (EPDM, FPM) 2 1/2"-4"
2 way Ball Valve, Color Type 35X	15 bar	1/2"-2" (EPDM)
Metering & laboratory Valves Type 323 & 322 (EPDM, FPM)	10 bar	1/8"-1/2"
Diaphragm Valve, Type 515, 514, 517, 317 (EPDM, PTFE, FPM, NBR, FPM)	15 bar 10 bar 6 bar	3/8"-2" 3/8"-4" 6"
Butterfly Valve, Type 567, 568, 037, 038 (EPDM, FPM)	10 bar 8 bar	2"-12" 14"-16"
Ball Check Valve Type 360/561 (EPDM, FPM)	15 bar	3/8"-2"
Electrically Actuated Ball Valves, Type 130 and Type 107 (EPDM, FPM)	15 bar	3/8"-4"
Pneumatic Actuated Ball Valves, Type 230 (EPDM, FPM)	15 bar	3/8"-4"
Pneumatic Actuated Diaphragm Valves, Diastar (EPDM, FPM)	15 bar 10 bar 6 bar	3/8"-2" 2"-4" 6"
Electrically Actuated Butterfly Valves, (EPDM, FPM)	10 bar 8 bar	2"-12" 14"-16"
Pneumatic Actuated Butterfly Valves, (EPDM, FPM)	10 bar 8 bar	2"-12" 14"-16"

PVC-U Metric Product Range

(for further details please contact your local Georg Fischer Supplier)

All the below pressure rating are with water at 20°C

Pipe

PN4	4 bar	d75-315
PN6	6 bar	d50-400
PN10	10 bar	d25-315
PN16	16 bar	d6-160
Clear PN4	4 bar	d63-d280
Clear PN6	6 bar	d12-63
Clear PN10	10 bar	d25-d110
Clear PN16	16 bar	d50-160

Fittings

Long Bends	16 bar	d20-160
Short Pattern Bend	10 bar	d225-280
	6 bar	d315-400
Elbows 90°	16 bar	d6-160
	10 bar	d200-250
Tee 90°	16 bar	d6-160
	10 bar	d200-280
	6 bar	d315-400
Tee 90° Reduced	16 bar	d25-160
	10 bar	d200-315
	6 bar	d400
Tee 45°	10 bar	d10-63
	6 bar	d75-250
Elbow 45°	16 bar	d16-160
	10 bar	d200-280
	6 bar	d315-400
Cross	16 bar	d10-63
	10 bar	d75-110
Socket	16 bar	d6-160
	10 bar	d200-280
	6 bar	d315-400
Cap	16 bar	d12-110
	10 bar	d140-280
	6 bar	d315
Flange Adaptors (Serrated, flat)	16 bar	d16-160
	10 bar	d200-280
	6 bar	d315-400
Union (EPDM and FPM)	16 bar	d16-63
	10 bar	d75-110
Short Reducing Bushes	16 bar	d12-160
	10 bar	d200-280
	6 bar	d315-400
Long Reducing Bushes	16 bar	d8-140

PVC-U Metric Product Range

(for further details please contact your local Georg Fischer Supplier)

All the below pressure rating are with water at 20°C

Adaptor Sockets (Female Thread x Socket)	16 bar 10 bar	d12-63 d75-110
Adaptor Sockets (Female Thread x Nipple)	16 bar with reinforcement	d12-63
Adaptor Bush (Socket x male thread)	16 bar 10 bar	d12-63 d75-110
Full Threaded Fittings (thread x thread)	10 bar	3/8"-2"
Adaptor Unions (Brass, ABS, Stainless Steel, Malleable Iron)	16 bar	d20-90
Accessories (Loose Flanges, Sets, Pipe Brackets etc.)		Various

Hand-operated and actuated valves

Ball Valve, Type 546 (EPDM and FPM)	16 bar	d16-110
3 way Ball Valve, Type 543 (EPDM and FPM)	10 bar	d16-d63
2 way Ball Valve, Type 375 (EPDM and FPM)	16 bar 10 bar	d16-63 d75-110
2 way Ball Valves, Coloro Type 35X (EPDM)	16 bar	d20-63
Metering & Laboratory Valves, Type 323 & 322 (EPDM and FPM)	10 bar	d10-20
Diaphragm Valve, Type 515, 514, 517, 317 (EPDM, PTFE, FPM, NBR)	16 bar 10 bar 6 bar	d16-63 d16-110 d160
Butterfly Valves, Type 567/568 (EPDM and FPM)	10 bar 8 bar	d63-315 d355-400
Ball Check Valve, Type 360 (EPDM and FPM)	16 bar 10 bar	d16-d63 d90
Electrically Actuated Ball Valves, Type 130 and Type 107 (EPDM and FPM)	16 bar	d16-d110
Pneumatic Actuated Ball Valves, Type 230 (EPDM and FPM)	16 bar	d16-d110

PVC-U Metric Product Range

(for further details please contact your local Georg Fischer Supplier)

All the below pressure rating are with water at 20°C

Pneumatic Actuated Diaphragm Valves, Diastar (EPDM, FPM)	16 bar	d16-63
	10 bar	d63-110
	6 bar	d160
Electrically Actuated Butterfly Valves, Diastar (EPDM, FPM)	10 bar	d63-315
	8 bar	d355-400
Pneumatic Actuated Butterfly Valves (EPDM, FPM)	10 bar	d63-315
	8 bar	d355-400



Abbreviations

AL	Number of bolt holes
ABS	Acrylonitrile Butadiene Styrene
ANSI	American National Standard Institute
CR	Chloroprene Rubber, e.g. Neopren
d	Pipe outside diameter
DIN	German standard
DN	Nominal bore
e	Wall thickness
EPDM	Ethylene Propylene Rubber
FM	Fusion Method
FPM	Fluorine Rubber, e.g. Viton®
kg	Weight in kilograms
G	Pipe thread, not pressure tight in the thread to ISO 288
HTR	High Temperature Resistant
ISO	International Standardization Organisation
Ms	Brass
NBR	Nitrile Rubber
NPT	Taper male thread pressure tight in the thread to ANSI B 1.20.1
PA	Polyamide
PBTP	Polybutylene terephthalate
PE	Polyethylene
PN	Nominal pressure at 20°C, water
PP	Polypropylene, heat stabilised
PTFE	Polytetrafluorethylene, e.g. Teflon®
PVC-C	Polyvinyl Chloride, chlorinated
PVC-U	Unplasticised Polyvinyl, chloride
PVDF	Polyvinylidene fluoride
R	Taper male thread, pressure tight in the thread to ISO 7
Rp	Parallel female thread, pressure tight in the thread to ISO 7
®	Registered trade-mark
s	Across flats
SAN	Styrene-acrylonitrile
SC	Size of hexagon bolts
SP	Standard pack. The figure given indicates the quantity of fittings contained in a standard pack
St	Steel
Tg	Malleable Iron
TM	Trade-mark
Tr	Trapezoid thread
PP-GF	Polypropylene, glassfibre reinforced

50 Years of application knowledge

GF CONTAIN-IT Plus PVC-U Double Containment System

Double containment is a safe and cost effective solution for the controlled conveyance of aggressive media.

Contain-IT Plus offers a patented pipe joining technology unlike any other containment system on the market. The technology allows the separate joining of the inner and outer pipe so the inner pipe can be joined and pressure tested before the outer is sealed so any leaks in the inner can be found and corrected. This gives a safety and installation advantage over other systems. Fittings are supplied fully contained, whereas pipe is supplied as standard GF inner and outer pipe so no special pipe is required. The pipe is used with centralisers to centre the inner pipe. The fittings offer a completely fixed joint so no further assembly is required for joining. The inner pipe is joined using standard Tangit or Dytex (for aggressive media) solvent cement procedures, and the outer is joined using either PE electrofusion, or EPDM mechanical couplers. A range of PVC-U grey, PE black, or PVC-U clear outer pipe can be used. Depending on the combination of fittings the Contain-IT Plus system can be offered with a 16 bar inner and 16 bar outer pressure rated system. A range of termination fittings, valves, and leak detection is also available from our GF Signet range.

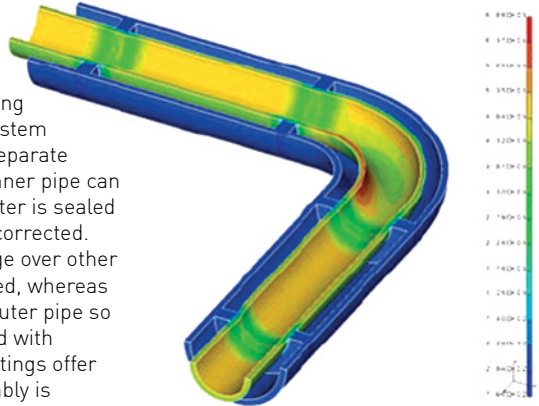

Fields of Application:

- Water treatment
- Chemical industry
- Power generation industry
- Food and beverage production

Product Range:

- Pipes
- Fittings
- Manual valves
- Actuated valves











EN/ISO – d20 – d225mm Inner PVC-U
– d50 – d315mm Outer PVC-U or PE

Contents

	Page
PVC-U BS Inch	3
PVC-U metric	29
Flow Sensors	199
Accessories	203
CONTAIN-IT	231
Index	253

PVC-U BS Inch

		Page
	Pipes	4
	Fittings for solvent cement jointing	6
	Adaptor Fittings	13
	Flanges	19
	Unions	22
	Adaptor unions	23
	Tank adaptors	26
	Saddles	27

Pipes

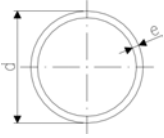

Pipe PVC-U grey class E 15 bar at 20°C

- Material: PVC-U, Polyvinylchloride unplasticised
- Dimensions: BS EN 1452 Part 1 & 2 (formerly BS 3505)
- Pipe length: 6m with plain ends
- Minimum order quantity: 1 length

Size (NB) [inch]	PN	Code	kg/m	e [mm]	di [mm]	d [mm]
3/8	15	161 018 080	0.114	1.5	14.1	17.1
1/2	15	161 018 082	0.161	1.7	17.9	21.3
3/4	15	161 018 083	0.225	1.9	22.9	26.7
1	15	161 018 084	0.325	2.2	29.0	33.4
1 1/4	15	161 018 085	0.503	2.7	36.8	42.2
1 1/2	15	161 018 086	0.659	3.1	42.1	48.3
2	15	161 018 087	1.038	3.9	52.5	60.3
2 1/2	16	161 017 112	1.820	5.6	58.2	
3	15	161 018 088	2.245	5.7	77.5	88.9
4	15	161 018 089	3.667	7.3	99.7	114.3
5	16	161 017 116	6.215	10.3	119.4	

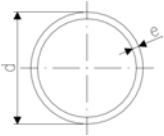

Pipe PVC-U grey class D 12 bar at 20°C

- Material: PVC-U, Polyvinylchloride unplasticised
- Dimensions: BS EN 1452 Part 1 & 2 (formerly BS 3505)
- Pipe length: 6m with plain ends
- Minimum order quantity: 1 length

Size (NB) [inch]	PN	Code	kg/m	e [mm]	di [mm]	d [mm]
1 1/4	12	161 018 059	0.420	2.2	37.8	42.2
1 1/2	12	161 018 060	0.550	2.5	43.3	48.3
2	12	161 018 061	0.900	3.1	54.1	60.3
3	12	161 018 063	1.930	4.6	79.7	88.9
4	12	161 018 064	3.230	6	102.3	114.3

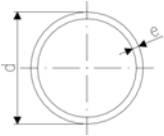

Pipe PVC-U grey class C 9 bar at 20°C

- Material: PVC-U, Polyvinylchloride unplasticised
- Dimensions: BS EN 1452 Part 1 & 2 (formerly BS 3505)
- Pipe length: 6m with plain ends
- Minimum order quantity: 1 length

Size (NB) [inch]	PN	Code	kg/m	e [mm]	di [mm]	d [mm]
2	9	161 018 036	0.694	2.5	55.3	60.3
3	9	161 018 038	1.434	3.5	81.9	88.9
4	9	161 018 039	2.358	4.5	105.3	114.3
6	9	161 018 042	5.058	6.6	155.1	168.3
8	9	161 018 045	1.388	7.8	203.5	219.1

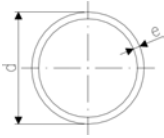

Pipe PVC-U grey class 7 (T) 12 bar at 20°C

- Thick wall pipe to allow for threading
- Material: PVC-U, Polyvinylchloride unplasticised
- Dimensions: BS EN 1452 Part 1 & 2 (formerly BS 3505)
- Pipe length: 6m with plain ends
- Minimum order quantity: 1 length

Size (NB) [inch]	PN	Code	kg/m	e [mm]	di [mm]	d [mm]
3/8	12	161 018 255	0.210	3.8	9.5	17.1
1/2	12	161 018 256	0.310	4	13.3	21.3
3/4	12	161 018 257	0.420	4.2	18.3	26.7
1	12	161 018 258	0.620	4.8	23.8	33.4
1 1/4	12	161 018 259	0.860	5.2	31.8	42.2
1 1/2	12	161 018 260	1.050	5.5	37.3	48.3
2	12	161 018 261	1.430	6	48.3	60.3

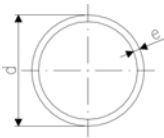

Pipe PVC-U grey SCH80 ASTM

- Material: PVC-U, Polyvinylchloride unplasticised
- Dimensions: ASTM D 1785
- Pipe length: 20ft with plain ends
- Minimum order quantity: 1 length

Size	PN	Code	d [mm]	e [mm]	di [mm]
1/2	58	8008005AB	21.3	3.7	13.9
3/4	47	8008007AB	26.7	3.9	18.8
1	43	8008010AB	33.4	4.5	24.3
1 1/4	35	8008012AB	42.2	4.9	32.5
1 1/2	32	8008015AB	48.3	5.1	38.1
2	27	8008020AB	60.3	5.5	49.3
3	25	8008030AB	88.9	7.6	73.7
4	22	8008040AB	114.3	8.6	97.2
6	19	8008060AB	168.3	11.0	146.3
8	16	8008080AB	219.1	12.7	193.7
10	15	8008100AB	273.0	15.1	242.9
12	15	8008120AB	323.9	17.4	289.0
14	15	8008140AB	355.6	19.1	317.5
16	15	8008160AB	406.4	21.4	363.6

Fittings for solvent cement jointing

21 00 11

Bend 90° PVC-U Inch BS



d [inch]	PN	Code	kg	z [mm]	D [mm]	L [mm]
½	15	721 001 106	0.026	40	29	58
¾	15	721 001 107	0.046	50	35	71
1	15	721 001 108	0.069	64	43	88
1 ¼	15	721 001 109	0.206	80	54	109
1 ½	15	721 001 110	0.312	100	64	131
2	15	721 001 111	0.556	126	76	163
2 ½	16	721 000 112	0.798	150	90	194
3	15	721 001 113	1.763	180	113	231
4	15	721 001 115	7.448	220	137	284
5	16	721 000 116	5.204	280	168	356
6	15	721 001 117	7.700	320	201	411

21 01 11

Bend 90° short pattern PVC-U Inch BS

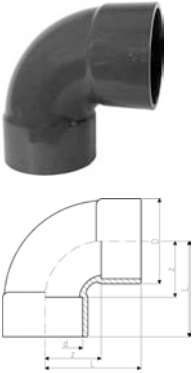

d [inch]	PN	Code	kg	z [mm]	D [mm]	L [mm]
8	9	721 011 120	8.297	168	256	287

21 10 11

Elbow 90° PVC-U Inch

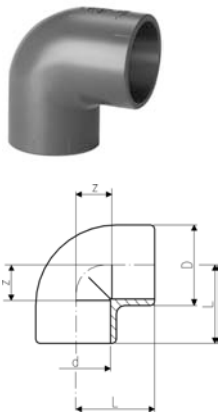

d [inch]	PN	Code	kg	z [mm]	D [mm]	L [mm]
¾	15	721 101 105	0.016	10	24	25
½	15	721 101 106	0.022	13	27	30
¾	15	721 101 107	0.025	14	33	34
1	15	721 101 108	0.038	17	40	39
1 ¼	15	721 101 109	0.078	22	51	49
1 ½	15	721 101 110	0.116	26	58	56
2	15	721 101 111	0.215	32	72	68
2 ½	16	721 100 112	0.330	40	87	83
3	15	721 101 113	0.606	46	107	97
4	15	721 101 115	1.335	59	137	122
5	16	721 100 116	1.945	70	162	146
6	15	721 101 117	4.530	86	201	176
8	15	806080	7.135	117	248	220
10	15	806100	20.450	146	305	273

table continued next page

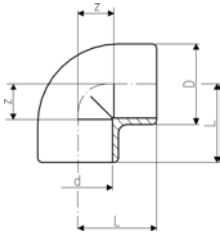

d [inch]	PN	Code	kg	z [mm]	D [mm]	L [mm]
12	15	806120	22.000	154	361	321
14	10	806140N	25.000	489	397	667
16	10	806160N	27.273	559	453	762

21 15 11

Elbow 45° PVC-U Inch

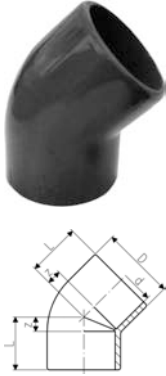

d [inch]	PN	Code	kg	z [mm]	D [mm]	L [mm]
3/8	15	721 151 105	0.008	4	22	19
1/2	15	721 151 106	0.012	5	27	21
3/4	15	721 151 107	0.020	6	33	25
1	15	721 151 108	0.037	8	41	30
1 1/4	15	721 151 109	0.060	10	51	37
1 1/2	15	721 151 110	0.089	11	58	41
2	15	721 151 111	0.137	14	72	50
2 1/2	16	721 150 112	0.253	17	87	61
3	15	721 151 113	0.534	20	107	70
4	15	721 151 115	0.957	25	134	89
5	16	721 150 116	1.570	32	162	108
6	15	721 151 117	2.915	38	198	129
8	9	721 151 120	5.800	52	250	168
10	15	817100	9.090	64	305	191
12	15	817120	11.360	76	361	229
14	10	817140N	13.640	89	397	267
16	10	817160N	15.909	95	453	298

21 20 11

Tee 90° equal PVC-U Inch

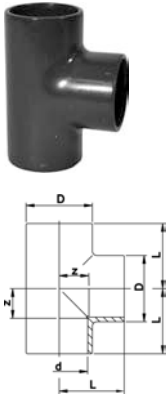

d [inch]	PN	Code	kg	z [mm]	D [mm]	L [mm]
3/8	15	721 201 105	0.018	10	25	25
1/2	15	721 201 106	0.036	13	30	30
3/4	15	721 201 107	0.051	16	35	37
1	15	721 201 108	0.079	19	43	43
1 1/4	15	721 201 109	0.105	22	50	51
1 1/2	15	721 201 110	0.157	26	57	56
2	15	721 201 111	0.294	32	72	68
2 1/2	16	721 200 112	0.476	39	87	83
3	15	721 201 113	0.847	46	107	97
4	15	721 201 115	2.002	59	138	122
5	16	721 200 116	3.487	71	169	147
6	15	721 201 117	5.477	86	202	176
8	9	721 201 120	10.415	114	256	233
10	15	801100	13.640	146	305	276
12	15	801120	15.910	173	361	330
14	10	801140N	18.180	276	397	495
16	10	801160N	20.455	308	453	578

21 20 11

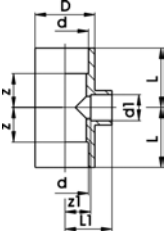
Tee 90° reducing Inch

d-d [inch]	PN	Code	kg	z [mm]	z1 [mm]	D [mm]	L [mm]	L1 [mm]
¾ - ½	15	721 201 134	0.034	14	14	33	33	30
1 - ½	15	721 201 141	0.056	17	17	41	39	33
1 - ¾	15	721 201 138	0.058	17	17	41	39	36
1 ¼ - ¾	15	721 201 151	0.132	22	22	50	49	42
1 ¼ - 1	15	721 201 147	0.128	29	28	62	59	44
1 ½ - ½	15	721 201 009	0.206	29	28	62	59	50
1 ½ - ¾	15	721 201 010	0.185	37	34	77	73	53
1 ½ - 1	15	721 201 164	0.211	37	34	77	73	56
2 - ¾	15	721 201 011	0.385	37	32	77	73	53
2 - 1	15	721 201 178	0.380	37	32	77	73	56
2 - 1 ½	15	721 201 170	0.511	38	32	73	68	68
3 - 2	15	801338	0.720	33	37	106	82	86
4 - 2	15	801420	2.280	32	37	132	89	99
4 - 3	15	721 201 137	1.990	72	59	138	122	122
5 - 2 ½	16	721 200 149	3.319	72	78	172	148	122
6 - 4	15	801532	4.400	89	72	194	167	173
8 - 6	15	801585	9.030	91	89	248	194	191

21 25 11

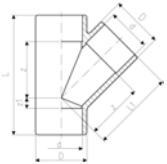
Tee 45° PVC-U Inch

d [inch]	PN	Code	kg	z [mm]	z1 [mm]	D [mm]	L [mm]	L1 [mm]
½	9	721 251 106	0.035	30	6	28	68	46
¾	9	721 251 107	0.052	35	8	33	83	55
1	9	721 251 108	0.090	43	8	41	99	67
1 ¼	9	721 251 109	0.145	55	9	50	118	82
1 ½	9	721 251 110	0.274	67	13	60	140	97
2	9	721 251 111	0.476	87	16	74	175	123
2 ½	6	721 250 112	0.816	101	18	91	207	145
3	6	721 251 113	1.324	122	20	107	245	173
4	6	721 251 115	2.403	147	25	134	298	210
5	6	721 250 116	5.628	190	34	168	376	266
6	10	870060	5.600	216	46	194	419	294
8	10	870080	11.600	281	52	248	540	387
10	6	875100N	25.900	502	140	305	806	629
12	6	875120N	41.500	578	165	361	953	730
14	6	875140N	56.700	660	178	397	1060	838
16	6	875160N	81.600	737	197	453	1200	940

21 30 11

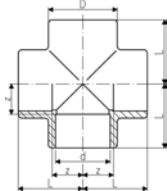
Cross PVC-U Inch BS

d [inch]	PN	Code	kg	z [mm]	D [mm]	L [mm]
3/4	12	721 301 107	0.050	14	36	33
1	12	721 301 108	0.081	17	44	39
1 1/4	12	721 301 109	0.130	22	53	49
1 1/2	12	721 301 110	0.299	30	64	60
2	12	721 301 111	0.556	37	80	74
2 1/2	10	721 300 112	0.725	40	92	83

21 91 11

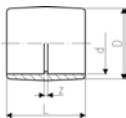
Socket equal PVC-U Inch

d [inch]	PN	Code	kg	z [mm]	D [mm]	L [mm]
3/8	15	721 911 105	0.007	3	23	32
1/2	15	721 911 106	0.011	3	27	36
3/4	15	721 911 107	0.018	3	33	45
1	15	721 911 108	0.029	3	41	51
1 1/4	15	721 911 109	0.048	3	51	57
1 1/2	15	721 911 110	0.070	3	58	63
2	15	721 911 111	0.128	3	72	77
2 1/2	16	721 910 112	0.188	4	87	92
3	15	721 911 113	0.350	7	104	107
4	15	721 911 115	0.606	8	134	135
5	16	721 910 116	1.118	7	162	159
6	15	721 911 117	1.789	11	197	192
8	9	721 911 120	4.140	10	253	248
10	9	829100	6.824	12		268
12	9	829120	9.900	13		319
14	9	829140N	11.364	70		425
16	9	829160N	13.636	76		483

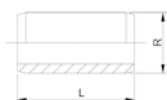
**Barrel Nipple, PVC-U
BS Inch****Model:**

- With solvent cement spigots on both sides
- For the shortest possible distance between fittings
- Overall length L = 2 x socket length

d [inch]	PN	Code	kg	L [mm]
3/8	16	721 901 905	0.002	29
1/2	16	721 901 906	0.004	33
3/4	16	721 901 907	0.008	39
1	16	721 901 908	0.015	45
1 1/4	16	721 901 909	0.027	54
1 1/2	16	721 901 910	0.050	60

table continued next page

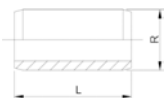

d [inch]	PN	Code	kg	L [mm]
2	16	721 901 911	0.098	72
2 ½	16	721 900 912	0.156	88
3	16	721 901 913	0.226	101
4	16	721 901 914	0.476	126
5	16	721 900 916	0.932	152

21 91 13

Reducing bush short pattern PVC-U Inch

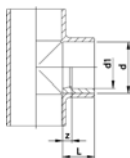

d [inch]	d1 [inch]	PN	Code	kg	z [mm]	L [mm]
* ½	¾	15	721 901 334	0.003	2	18
* ¾	¾	15	721 901 338	0.013	5	21
* ¾	½	15	721 901 337	0.005	3	21
1	¾	15	721 901 343	0.013	8	24
* 1	½	15	721 901 342	0.015	6	24
* 1	¾	15	721 901 341	0.010	3	24
1 ¼	¾	15	721 901 349	0.024	13	29
1 ¼	½	15	721 901 348	0.023	11	29
1 ¼	¾	15	721 901 347	0.025	8	29
* 1 ¼	1	15	721 901 346	0.018	5	29
1 ½	½	15	721 901 355	0.033	13	30
1 ½	¾	15	721 901 354	0.034	10	30
* 1 ½	1	15	721 901 353	0.038	6	30
* 1 ½	1 ¼	15	721 901 352	0.018	2	30
2	¾	15	721 901 361	0.060	16	37
2	1	15	721 901 360	0.063	13	37
* 2	1 ¼	15	721 901 359	0.070	8	37
* 2	1 ½	15	721 901 358	0.051	6	37
* 2 ½	2	15	721 901 364	0.094	8	45
3	1	15	721 901 374	0.178	3	50
3	1 ½	15	721 901 372	0.176	3	50
3	2	15	721 901 371	0.178	3	50
* 3	2 ½	15	721 901 370	0.124	6	51
4	2	15	837420	0.517	29	69
* 4	3	15	721 901 381	0.340	13	64
* 5	4	15	721 901 384	0.530	13	76
6	3	15	837530	0.691	36	93
6	4	15	837532	1.588	29	93
* 6	5	15	721 901 388	0.830	15	91
8	6	9	721 901 396	1.769	33	119
10	6	10	837626FB	3.590	65	144
10	8	15	837628	6.820	40	144
12	8	10	837668FB	9.091	67	171
12	10	15	837670	9.100	41	171
14	10	10	837702N	11.364	51	191
14	12	10	837704N	11.364	25	191
16	12	10	837738N	13.636	51	216
16	14	10	837740N	13.636	25	216

Reducing bush long pattern PVC-U Inch BS

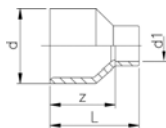

d [inch]	d1 [inch]	PN	Code	kg	z [mm]	L [mm]
5	3	15	721 911 386	0.730	111	162
6	4	15	721 911 389	1.324	133	197

Reducing coupling socket x socket PVC-U Inch

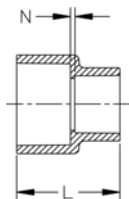

d [inch]	d1 [inch]	PN	Code	L [mm]	N [mm]	Design
¾	½	15	829101	55	4	
1	½	15	829130	54	2	
1	¾	15	829131	57	3	
1 ¼	1	15	829168	65	2	
1 ½	½	15	829209FB	85	4	BUSH
1 ½	¾	15	829210	85	4	BUSH
1 ½	1	15	829211	68	3	
1 ½	1 ¼	15	829212	72	3	
2	½	15	829247FB	85	22	BUSH
2	¾	15	829248FB	85	20	BUSH
2	1	15	829249	79	8	
2	1 ¼	15	829250	76	3	
2	1 ½	15	829251	77	3	
3	1 ½	15	829337FB	116	29	BUSH
3	2	15	829338	92	4	
4	2	15	829420FB	125	28	BUSH
4	3	15	829422	112	7	
6	4	15	829532	260	89	
8	4	15	829582FB	248	87	BUSH
8	6	15	829585	235	53	
10	4	15	829623N	445	267	FAB
10	6	15	829626N	337	133	FAB
10	6	15	829626FB	278	74	BUSH
10	8	15	829628N	324	95	FAB
10	8	15	829628FB	284	53	BUSH
12	8	15	829668N	394	140	FAB
12	8	15	829668FB	340	75	BUSH
12	10	15	829670N	381	102	FAB
12	10	15	829670FB	336	54	BUSH
14	10	10	829702N	432	127	FAB
14	12	10	829704N	419	89	FAB
16	12	10	829738N	489	133	FAB
16	14	10	829740N	495	114	FAB

Cap PVC-U Inch

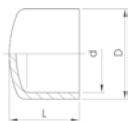

d [inch]	PN	Code	kg	D [mm]	L [mm]
3/8	15	721 961 105	0.007	26	23
1/2	15	721 961 106	0.009	30	25
3/4	15	721 961 107	0.016	37	30
1	15	721 961 108	0.025	44	34
1 1/4	15	721 961 109	0.038	55	41
1 1/2	15	721 961 110	0.071	62	44
2	15	721 961 111	0.133	78	54
2 1/2	16	721 960 112	0.152	87	65
3	15	721 961 113	0.323	112	77
4	15	721 962 115	0.762	145	101
5	10	721 960 116	1.036	164	92
6	15	847060	1.560	194	125
8	15	847080	3.440	248	160
10	15	847100	5.560	305	200
12	15	847120	8.280	361	238
14	10	847140	15.880	397	146
16	10	847160	16.560	453	190

Adaptor Fittings

21 10 12

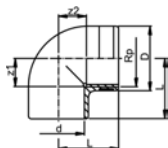

Elbow 90° PVC-U Inch BS Rp

Model:

- With solvent cement socket BS Inch and parallel female thread Rp
- Reinforcing ring stainless (A2)
- Connection to plastic or metal threads
- Do not use thread sealing pastes that are harmful to PVC-U
- Install with low mechanical stress and avoid large cyclic temperature changes

d [inch]	Rp [inch]	PN	Code	kg	z1 [mm]	z2 [mm]	D [mm]	L [mm]
1/2	1/2	15	721 101 206	0.022	10	15	30	27
3/4	3/4	15	721 101 207	0.033	13	19	35	33
1	1	15	721 101 208	0.058	16	24	45	39

21 20 12

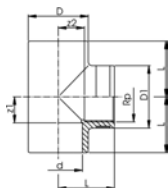

Tee 90°, PVC-U BS Inch - Rp

Model:

- With solvent cement socket BS Inch and parallel female thread Rp
- Reinforcing ring stainless (A2)
- Connection to plastic or metal threads
- Do not use thread sealing pastes that are harmful to PVC-U
- Install with low mechanical stress and avoid large cyclic temperature changes

d [inch]	Rp [inch]	PN	Code	kg	z1 [mm]	z2 [mm]	D [mm]	D1 [mm]	L [mm]
3/8	3/8	16	721 201 205	0.028	10	14	25	25	26
1/2	1/2	16	721 201 206	0.028	10	13	30	26	29
3/4	3/4	16	721 201 207	0.033	13	15	35	32	33
1	1	16	721 201 208	0.111	17	19	45	40	39

21 90 14

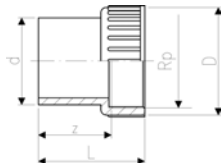

Adaptor Bush equal, PVC-U BS Inch - Rp

Model:

- With solvent cement spigot BS Inch and parallel female thread Rp
- Connection to plastic threads only
- Do not use thread sealing pastes that are harmful to PVC-U
- Install with low mechanical stress and avoid large cyclic temperature changes

d [inch]	Rp [inch]	PN	Code Code	kg	z [mm]	D [mm]	L [mm]
1/2	1/2	15	721 901 406	0.012	21	28	37
3/4	3/4	15	721 901 407	0.019	23	34	41
1	1	15	721 901 408	0.036	27	42	48
1 1/4	1 1/4	15	721 901 409	0.065	33	52	56
1 1/2	1 1/2	15	721 901 410	0.092	38	62	61
2	2	15	721 901 411	0.160	47	77	74

21 91 14

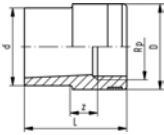

Reducing Bush, PVC-U BS Inch

Model:

- With solvent cement socket BS Inch and parallel female thread Rp
- Reinforcing ring stainless (A2)
- Connection to plastic or metal threads
- Do not use thread sealing pastes that are harmful to PVC-U
- Install with low mechanical stress and avoid large cyclic temperature changes

d [inch]	Rp [inch]	PN	Code Code	kg	D [mm]	L [mm]	z [mm]
3/8	1/2	16	721 911 434	0.020	30	40	8

21 91 17

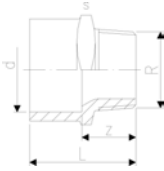

Adaptor Bush equal, PVC-U BS Inch - R

Model:

- With solvent cement socket BS Inch and taper male thread R
- Do not use thread sealing pastes that are harmful to PVC-U
- Install with low mechanical stress and avoid large cyclic temperature changes

d [inch]	R [inch]	PN	Code Code	kg	z [mm]	L [mm]	s [mm]
3/8	3/8	15	721 911 705	0.013	20	34	27
1/2	1/2	15	721 911 706	0.017	24	40	32
3/4	3/4	15	721 911 707	0.022	25	44	36
1	1	15	721 911 708	0.036	28	50	46
1 1/4	1 1/4	15	721 911 709	0.055	31	57	55
1 1/2	1 1/2	15	721 911 710	0.097	32	63	65
2	2	15	721 911 711	0.176	38	76	80
2 1/2	2 1/2	10	721 910 712	0.227	42	86	90

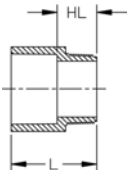

Adaptor bush PVC-U Inch NPT

Model:

- With solvent cement socket Inch and taper male thread NPT
- Do not use thread sealing pastes that are harmful to PVC-U
- Install with low mechanical stress and avoid large cyclic temperature changes

Inch Size [inch]	Code	kg	L [mm]	HL min. [mm]
1/2	836005	0.020	47	24
3/4	836007	0.030	52	25
1	836010	0.040	61	31
1 1/4	836012	0.060	65	33
1 1/2	836015	0.080	69	34
2	836020	0.120	73	34
3	836030	0.310	100	51
4	836040	0.510	112	53

21 91 17

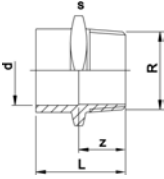

Adaptor Bush reducing, PVC-U BS Inch - R

Model:

- With solvent cement socket BS Inch and taper male thread R
- Do not use thread sealing pastes that are harmful to PVC-U
- Install with low mechanical stress and avoid large cyclic temperature changes

d [inch]	R [inch]	PN	Code Code	kg	z [mm]	L [mm]	s [mm]
1/2	3/4	15	721 911 737	0.050	22	40	36
3/4	1	15	721 911 741	0.034	27	48	46
1	1 1/4	15	721 911 746	0.052	29	53	55
1 1/4	1 1/2	15	721 911 752	0.060	29	58	65
1 1/2	2	15	721 911 758	0.071	34	64	80

21 91 15

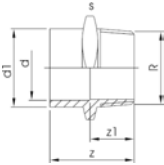

Adaptor Socket Nipple, PVC-U BS Inch - R

Model:

- With solvent cement spigot/reducing socket and taper male thread R
- Do not use thread sealing pastes that are harmful to PVC-U
- Install with low mechanical stress and avoid large cyclic temperature changes

d [inch]	d1 [inch]	R [inch]	PN	Code Code	kg	z [mm]	z1 [mm]	s [mm]
1/4	3/8	3/8	15	721 911 555	0.011	36	21	27
3/8	1/2	1/2	15	721 911 556	0.019	43	28	32
1/2	3/4	3/4	15	721 911 557	0.019	48	31	36
3/4	1	1	15	721 911 558	0.040	55	35	46

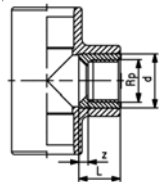

Reducing Bush short, PVC-U BS Inch - Rp

Model:

- With solvent cement spigot BS and parallel female thread Rp
- Connection to plastic threads only
- Do not use thread sealing pastes that are harmful to PVC-U
- Install with low mechanical stress and avoid large cyclic temperature changes

d [inch]	Rp [inch]	PN	Code Code	kg	z [mm]	L [mm]
1/2	3/8	15	721 901 534	0.003	3	18
3/4	1/2	15	721 901 537	0.007	5	21
1	3/4	15	721 901 541	0.011	4	24
1	1/2	15	721 901 542	0.017	8	24

21 91 39

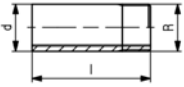

Adaptor Nipple, PVC-U BS Inch - R

Model:

- With solvent cement spigot BS Inch and taper male thread R
- Do not use thread sealing pastes that are harmful to PVC-U
- Install with low mechanical stress and avoid large cyclic temperature changes

d [inch]	R [inch]	PN	Code Code	kg	L [mm]
3/8	3/8	15	721 913 905	0.007	43
1/2	1/2	15	721 913 906	0.013	50
3/4	3/4	15	721 913 907	0.022	56
1	1	15	721 913 908	0.034	63
1 1/4	1 1/4	15	721 913 909	0.060	75
1 1/2	1 1/2	15	721 913 910	0.082	88
2	2	15	721 913 911	0.111	88
3	3	15	721 913 913	0.253	128
4	4	15	721 913 915	0.486	153

21 91 10

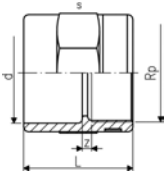

Adaptor socket PVC-U Inch BS Rp

Model:

- With solvent cement socket BS Inch and parallel female thread Rp
- Reinforcing ring stainless (A2)
- Connection to plastic or metal threads
- Do not use thread sealing pastes that are harmful to PVC-U
- Install with low mechanical stress and avoid large cyclic temperature changes

d [inch]	Rp [inch]	PN	Code Code	kg	z [mm]	L [mm]	s [mm]
3/8	3/8	15	721 911 005	0.016	4	31	27
1/2	1/2	15	721 911 006	0.024	4	35	32
3/4	3/4	15	721 911 007	0.030	3	40	36
1	1	15	721 911 008	0.055	3	45	46
1 1/4	1 1/4	15	721 911 009	0.083	3	51	55
1 1/2	1 1/2	15	721 911 010	0.127	8	59	65
2	2	15	721 911 011	0.218	8	69	80

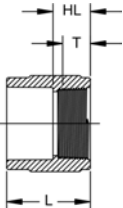

Adaptor socket PVC-U Inch NPT

Model:

- With solvent cement socket Inch and NPT (ASTM) taper female thread
- Connection to plastic threads only
- Do not use thread sealing pastes that are harmful to PVC-U
- Install with low mechanical stress and avoid large cyclic temperature changes

Inch Size [inch]	Code	kg	HL min. [mm]	T [mm]	L [mm]
1/2	835005	0.040	23	13	45
3/4	835007	0.050	24	14	50
1	835010	0.080	28	17	57
1 1/4	835012	0.110	29	18	62
1 1/2	835015	0.140	30	18	66
2	835020	0.200	31	19	70
3	835030	0.470	49	30	97
4	835040	0.720	51	33	109

21 91 31

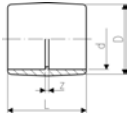

Adaptor Socket, PVC-U metric - BS Inch

Model:

- With solvent cement sockets metric and BS inch

d [mm]	d [inch]	PN	Code	kg	z [mm]	D [mm]	L [mm]
16	3/8	16	721 913 105	0.010	5	23	35
20	1/2	16	721 913 106	0.012	5	27	38
25	3/4	16	721 913 107	0.020	5	33	45
32	1	16	721 913 108	0.031	5	41	51
40	1 1/4	16	721 913 109	0.054	5	51	60
50	1 1/2	16	721 913 110	0.074	4	59	65
63	2	16	721 913 111	0.155	5	75	79
90	3	16	721 913 113	0.340	6	104	108
110	4	16	721 913 115	0.488	4	128	128

21 55 14

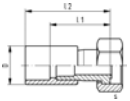

Tap Connector, PVC-U BS Inch - Rp

Model:

- With solvent cement socket BS Inch and brass parallel female thread Rp

d [inch]	Rp [inch]	Code Code	kg	D [mm]	l1 [mm]	l2 [mm]	s [mm]
3/8	1/2	721 551 405	0.040	23	39	55	24
1/2	3/4	721 551 406	0.042	27	43	60	31

21 96 14

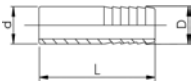

Hose connector PVC-U Inch BS

Model:

- With solvent cement spigot and parallel hose connection

d [inch]	PN	Code	kg	D [mm]	L [mm]
1/4	15	721 961 404	0.005	12	51

21 96 07

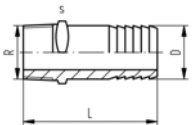

Hose connector PVC-U R

Model:

- With taper male thread R
- With parallel hose connector
- Do not use thread sealing pastes that are harmful to PVC-U

R [inch]	PN	Code	kg	D [mm]	L [mm]	s [mm]
1/4	10	721 960 704	0.003	12	59	14
3/8	10	721 960 705	0.006	16	67	19
1/2	10	721 960 706	0.020	20	86	22
3/4	10	721 960 707	0.027	25	92	27
1	10	721 960 708	0.048	30	103	36
1 1/4	10	721 960 709	0.079	40	115	46

21 96 17

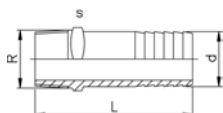

Hose connector PVC-U R reduced

Model:

- With taper male thread R
- With parallel hose connector
- Connection to plastic threads only
- Do not use thread sealing pastes that are harmful to PVC-U

R [inch]	Code	kg	d [mm]	L [mm]	s [mm]
1/2	721 961 706	0.012	14	70	22
3/4	721 961 707	0.021	20	80	27
1	721 961 708	0.042	27	90	36

Flanges

21 79 11

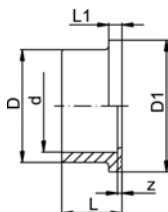

Flange adaptor PVC-U Combined jointing face flat and serrated Inch BS

Model:

- Counterpart:
Flange Adaptor serrated BS Inch No. 21 79 11
Flange Adaptor serrated metric No. 21 79 01
- Gasket: Flat gasket EPDM No. 48 40 03

d [inch]	DN [mm]	PN	Code	kg	z [mm]	D [mm]	D1 [mm]	L [mm]	L1 [mm]
1/2	15	15	721 791 106	0.009	3	27	34	21	6
3/4	20	15	721 791 107	0.014	3	33	41	24	7
1	25	15	721 791 108	0.023	3	41	50	27	7
1 1/4	32	15	721 791 109	0.035	3	50	61	32	8
1 1/2	40	15	721 791 110	0.058	3	61	73	33	8
2	50	15	721 791 111	0.107	3	77	91	40	9
2 1/2	65	16	721 790 112	0.159	3	91	106	47	10
3	80	15	721 791 113	0.269	5	108	125	56	11
4	100	15	721 791 115	0.422	5	136	155	69	12
5	125	16	721 790 116	0.725	5	165	188	81	14
6	150	15	721 791 117	1.172	5	198	217	96	16
8	200	9	721 791 120	2.028	6	248	274	122	20
10	250	9	721 791 122	3.677	9	307	329	151	23
12	300	6	721 791 123	3.418	4	346	379	172	27

21 73 11

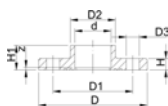

Full face flange PVC-U Inch BS Drilled to BS 10 table D and E

Model:

- Jointing face serrated
- Solvent cement socket BS inch
- It is recommended to use backing flanges in conjunction with all Full Face Flanges
- For pressure ratings over 2 bar backing flanges must be used
- All Full Face Flanges are manufactured with outside diameter to BS EN 1092

AL: number of holes

d [inch]	DN [mm]	PN	Code	kg	D [mm]	D1 [mm]	D2 [mm]	D3 [mm]	H [mm]	H1 [mm]	AL	z [mm]
1/2	15	15	721 731 106	0.083	95	67	27	15	10	21	4	3
3/4	20	15	721 731 107	0.106	105	73	33	15	10	24	4	3
1	25	15	721 731 108	0.129	115	83	41	15	10	27	4	3
1 1/4	32	15	721 731 109	0.189	140	87	50	15	10	32	4	3
1 1/2	40	15	721 731 110	0.236	150	98	61	15	10	33	4	3
2	50	15	721 731 111	0.309	165	114	77	18	10	40	4	3
3	80	15	721 731 113	0.540	200	146	108	18	12	56	4	5
4	100	15	721 731 114	0.889	220	178	136	18	17	69	8	5
6	150	15	721 731 117	2.022	285	235	198	22	22	96	8	5

21 73 01
21 73 11

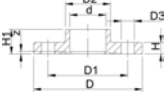

Full face flange PVC-U Inch BS Drilled to BS EN 1092 PN10/16

Model:

- Jointing face serrated
- Solvent cement socket BS inch
- It is recommended to use backing flanges in conjunction with all Full Face Flanges
- For pressure ratings over 2 bar backing flanges must be used
- All Full Face Flanges are manufactured with outside diameter to BS EN 1092
- ¹ connecting dimensions: BS 4504 and BS 10 table E

AL: number of holes

d [inch]	DN [mm]	PN	Code	kg	D [mm]	D1 [mm]	D2 [mm]	D3 [mm]	H [mm]	H1 [mm]	AL	z [mm]
½	15	15	721 731 106	0.083	95	67	27	15	10	21	4	3
¾	20	15	721 731 107	0.106	105	73	33	15	10	24	4	3
1	25	15	721 731 108	0.129	115	83	41	15	10	27	4	3
1 ¼	32	15	721 730 109	0.190	140	100	50	15	10	32	4	3
1 ½	40	15	721 730 110	0.242	150	110	61	15	10	33	4	3
2	50	15	721 730 111	0.320	165	125	77	18	10	40	4	3
3	80	15	721 730 113	0.543	200	160	108	18	12	56	4	5
4	100	15	721 731 114	0.889	220	178	136	18	17	69	8	5
6	150	15	721 730 117	2.084	285	240	198	22	22	96	8	5

21 73 21

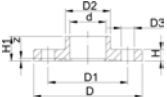

Full face flange PVC-U Inch BS Drilled to ASME B 16.5 class 150

Model:

- Jointing face serrated
- Solvent cement socket BS inch
- It is recommended to use backing flanges in conjunction with all Full Face Flanges
- For pressure ratings over 2 bar backing flanges must be used
- All Full Face Flanges are manufactured with outside diameter to BS EN 1092

AL: number of holes

d [inch]	DN [mm]	PN	Code	kg	D [mm]	D1 [mm]	D2 [mm]	D3 [mm]	H [mm]	H1 [mm]	AL	z [mm]
½	15	15	721 732 106	0.085	95	60	27	16	10	21	4	3
¾	20	15	721 732 107	0.100	105	70	33	16	10	24	4	3
1	25	15	721 732 108	0.134	115	79	41	16	10	27	4	3
1 ¼	32	15	721 731 109	0.189	140	87	50	15	10	32	4	3
1 ½	40	15	721 731 110	0.236	150	98	61	15	10	33	4	3
2	50	15	721 732 111	0.320	165	115	77	19	10	40	4	3
3	80	15	721 732 113	0.720	200	152	108	19	12	56	4	5
4	100	15	721 732 114	0.880	220	190	136	19	17	69	8	5
6	150	15	721 730 117	2.084	285	240	198	22	22	96	8	5

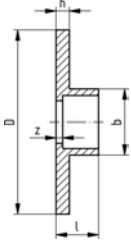

Full face flange PVC-U Inch BS Undrilled

Model:

- Jointing face serrated
- Solvent cement socket BS inch
- It is recommended to use backing flanges in conjunction with all Full Face Flanges
- For pressure ratings over 2 bar backing flanges must be used
- All Full Face Flanges are manufactured with outside diameter to BS EN 1092

d [inch]	DN [mm]	PN	Code	kg	z	D [mm]	h [mm]	b [mm]	l [mm]
½	15	15	721 730 006	0.096	3	95	10	27	21
¾	20	15	721 730 007	0.115	3	105	10	33	24
1	25	15	721 730 008	0.143	3	115	10	41	27
1 ¼	32	15	721 730 009	0.212	3	140	10	50	32
1 ½	40	15	721 730 010	0.262	3	150	10	61	33
2	50	15	721 730 011	0.330	3	165	10	77	40
3	80	15	721 730 013	0.573	5	200	12	108	56
4	100	15	721 730 014	0.957	5	220	17	136	69
6	150	15	721 730 017	2.172	5	285	22	198	96

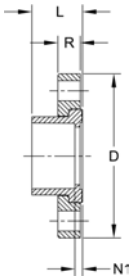

Full Face Van Stone Flange PVC-U Inch Drilled to ANSI B 16.5 class 150

Model:

- With solvent cement socket ASTM
- Jointing face serrated

d [inch]	DN [mm]	PN	Code	kg	D [mm]	R [mm]	L [mm]	N [mm]	AL
½	15	10	854005	0.109	89	14	26	3	4
¾	20	10	854007	0.141	99	15	29	3	4
1	25	10	854010	0.181	108	17	17	3	4
1 ¼	32	10	854012	0.236	118	18	37	4	4
1 ½	40	10	854015	0.299	127	19	40	4	4
2	50	10	854020	0.535	152	21	45	5	4
3	80	10	854030	1.129	191	26	57	8	4
4	100	10	854040	1.574	229	28	67	9	8
6	150	10	854060	2.540	279	35	88	9	8
8	200	10	854080	3.651	343	44	114	10	8
10	250	10	854100	6.486	406	44	143	13	12
12	300	10	854120	10.533	484	44	170	14	12
14	350	6	854140N	15.000	533	25	298	121	12
16	400	6	854160N	15.909	597	25	343	140	16

Unions

21 51 11

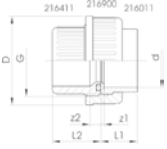

Union for solvent cement jointing PVC-U Inch BS

Model:

- Union End: Solvent cement socket BS Inch
- Union Bush: Solvent cement socket BS Inch
- Gasket: O-Ring EPDM No. 48 41 00, FPM No. 49 41 00

d [inch]	PN	EPDM Code	FPM Code	kg
3/8	15	721 511 105	721 511 130	0.025
1/2	15	721 511 106	721 511 131	0.040
3/4	15	721 511 107	721 511 132	0.064
1	15	721 511 108	721 511 133	0.088
1 1/4	15	721 511 109	721 511 134	0.133
1 1/2	15	721 511 110	721 511 135	0.204
2	15	721 511 111	721 511 136	0.366
2 1/2	10	721 510 112	721 510 137	0.621

d [inch]	z1 [mm]	z2 [mm]	D [mm]	L1 [mm]	L2 [mm]	G/Tr
3/8	3	8	35	19	24	3/4
1/2	3	9	43	21	26	1
3/4	3	9	51	24	29	1 1/4
1	3	9	58	27	33	1 1/2
1 1/4	3	10	72	32	39	2
1 1/2	3	10	83	33	46	2 1/4
2	3	10	100	40	58	2 3/4
2 1/2	3	18	135	47	62	Tr108x5

Adaptor unions

21 51 12

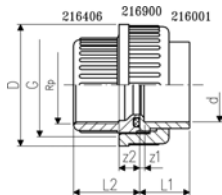

Adaptor union PVC-U Inch BS Rp

Model:

- Union End: Solvent cement socket BS Inch
- Union Bush: Parallel female thread Rp
- Gasket: O-Ring No. 48 41 00
- Connection to plastic threads only
- Do not use thread sealing pastes that are harmful to PVC-U

d [inch]	Rp [inch]	PN	Code	kg	z1 [mm]	z2 [mm]	D [mm]	L1 [mm]	L2 [mm]	G [inch]
3/8	3/8	10	721 511 205	0.025	3	13	35	17	24	3/4
1/2	1/2	10	721 511 206	0.042	3	13	43	19	26	1
3/4	3/4	10	721 511 207	0.068	3	14	51	22	29	1 1/4
1	1	10	721 511 208	0.094	3	15	58	25	32	1 1/2
1 1/4	1 1/4	10	721 511 209	0.168	3	19	72	29	38	2
1 1/2	1 1/2	10	721 511 210	0.223	3	26	83	34	45	2 1/4
2	2	10	721 511 211	0.405	3	33	100	41	56	2 3/4

21 53 13

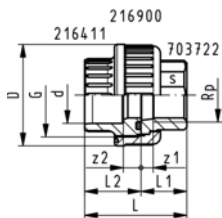

Adaptor union PVC-U/malleable iron galvanised Inch BS Rp

Model:

- Union nut: PVC-U
- Union Bush: Solvent cement socket BS Inch
- Union End: malleable iron with parallel female thread Rp
- Gasket: O-Ring EPDM No. 48 41 00

d [inch]	Rp [inch]	Code	kg
1/2	1/2	721 531 306	0.120
3/4	3/4	721 531 307	0.190
1	1	721 531 308	0.250
1 1/4	1 1/4	721 531 309	0.400
1 1/2	1 1/2	721 531 310	0.510
2	2	721 531 311	0.780
	2 1/2	721 530 312	1.008
3	3	721 531 313	1.740

d [inch]	D [mm]	L [mm]	L1 [mm]	L2 [mm]	z1 [mm]	z2 [mm]	G [inch]	s [mm]
1/2	43	48	22	26	9	10	1	25
3/4	51	51	22	29	7	10	1 1/4	31
1	58	58	26	33	9	10	1 1/2	38
1 1/4	72	69	31	39	12	12	2	48
1 1/2	83	78	33	46	14	14	2 1/4	54
2	100	91	35	58	11	18	2 3/4	67
	127	101	39	62	12	18	Tr 108x5	85
3	150	114	45	69	15	19	Tr 128x5	96

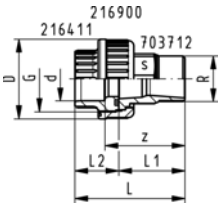

Adaptor union PVC-U/malleable iron galvanised Inch BS R

Model:

- Union nut: PVC-U
- Union Bush: Solvent cement socket BS Inch
- Union End: Malleable iron with taper male thread R
- Gasket: O-Ring EPDM No. 48 41 00

d	R	Code	kg	D	L	L1	L2	z	G	s
[inch]	[inch]			[mm]	[mm]	[mm]	[mm]	[mm]	[inch]	[mm]
1/2	1/2	721 531 806	0.156	43	66	40	26	50		1
3/4	3/4	721 531 807	0.230	51	72	43	29	53		1 1/4
1	1	721 531 808	0.330	58	80	48	33	58		1 1/2
1 1/4	1 1/4	721 531 809	0.480	72	95	57	39	69		2
1 1/2	1 1/2	721 531 810	0.683	83	104	59	46	73		2 1/4
2	2	721 531 811	1.082	100	118	62	58	80		2 3/4
	2 1/2	721 530 812	1.441	127	137	75	62	93	Tr 108x5	85
3	3	721 531 813	1.891	150	149	80	69	99	Tr 128x5	96

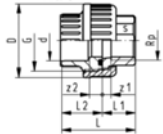

Adaptor union PVC-U/brass Inch BS Rp

Model:

- Union nut: PVC-U
- Union Bush: Solvent cement socket BS Inch
- Union End: Brass with parallel female thread Rp
- Gasket: O-Ring EPDM No. 48 41 00

d	Rp	PN*	Code	kg
[inch]	[inch]	[bar]		
1/2	1/2	15	721 551 506	0.093
3/4	3/4	15	721 551 507	0.145
1	1	15	721 551 508	0.193
1 1/4	1 1/4	15	721 551 509	0.344
1 1/2	1 1/2	15	721 551 510	0.509
2	2	15	721 551 511	0.776
	2 1/2	16	721 550 512	1.360
3	3	15	721 551 513	2.120

d	Rp	D	L	L1	L2	z1	z2	G	s
[inch]	[inch]	[mm]	[mm]	[mm]	[mm]	[mm]	[mm]	[inch]	[mm]
1/2	1/2	43	48	22	26	7	9		1
	3/4	51	54	25	29	9	8		1 1/4
	1	58	60	27	33	8	9		1 1/2
	1 1/4	72	70	31	39	10	11		2
	1 1/2	83	75	35	41	13	11		2 1/4
	2	100	88	40	48	14	12		2 3/4
	2 1/2	127	109	47	62	16	18	Tr 108x5	85
3	3	150	121	52	69	18	19	Tr 128x5	95

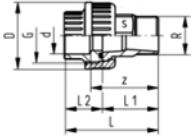

Adaptor union PVC-U/brass Inch BS R

Model:

- Union nut: PVC-U
- Union Bush: Solvent cement socket BS inch
- Union End: Brass with taper male thread R
- Gasket: O-ring EPDM No. 48 41 00

d [inch]	R [inch]	PN* [bar]	Code	kg
1/2	1/2	15	721 551 906	0.132
3/4	3/4	15	721 551 907	0.196
1	1	15	721 551 908	0.297
1 1/4	1 1/4	15	721 551 909	0.519
1 1/2	1 1/2	15	721 551 910	0.723
2	2	15	721 551 911	1.091
	2 1/2	16	721 550 912	1.706
3	3	15	721 551 913	2.788

d [inch]	R [inch]	D [mm]	L [mm]	L1 [mm]	L2 [mm]	z [mm]	G [inch]	s [mm]
1/2	1/2	43	63	37	26	46		1
3/4	3/4	51	71	42	29	50	1 1/4	30
1	1	58	79	46	33	55	1 1/2	36
1 1/4	1 1/4	72	91	52	39	63		2
1 1/2	1 1/2	83	97	56	41	67		2 1/4
2	2	100	115	67	48	78		2 3/4
	2 1/2	127	139	77	62	95	Tr 108x5	85
3	3	150	155	86	69	104	Tr 128x5	95

21 51 31

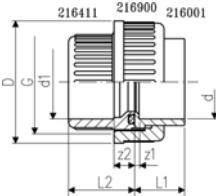

Adaptor union, PVC-U BS Inch

Model:

- Union End: Solvent cement socket metric
- Union Bush: Solvent cement socket BS inch
- Gasket: O-ring EPDM No. 48 41 00
- Can be supplied with FPM O-Ring No. 49 41 00

d [mm]	d1 [inch]	PN	Code	kg	z1 [mm]	z2 [mm]	D [mm]	L1 [mm]	L2 [mm]	G [inch]
16	3/8	15	721 513 105	0.025	3	8	35	17	24	3/4
20	1/2	15	721 513 106	0.040	3	9	43	19	26	1
25	3/4	15	721 513 107	0.065	3	9	51	22	29	1 1/4
32	1	15	721 513 108	0.090	3	9	58	25	33	1 1/2
40	1 1/4	15	721 513 109	0.155	3	10	72	29	39	2
50	1 1/2	15	721 513 110	0.200	3	10	83	34	46	2 1/4
63	2	15	721 513 111	0.341	3	10	100	41	58	2 3/4

Tank adaptors

61 10 87

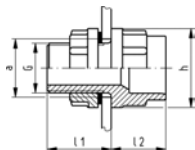

Tank Adaptor, PVC-U BS Inch

Model:

- With solvent cement socket BS Inch and parallel female thread G
- Gasket: flat gasket EPDM
- Can be supplied with FPM O-Ring No. 49 41 00

d [inch]	PN	Code Code	kg	h [mm]	I1 [mm]	I2 [mm]	a [mm]	G [inch]
1/2	15	161 108 706	0.050	37	34	24	23	1/2
3/4	15	161 108 707	0.048	42	34	29	28	3/4

61 05 02

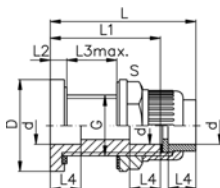

Tank Adaptor, PVC-U BS Inch

Model:

- End connection: Union with solvent cement socket BS Inch
- Gasket: flat gasket EPDM
- Can be supplied with FPM O-Ring No. 49 41 00

d [inch]	Code Code	kg
1/2	161 050 226	0.122
3/4	161 050 227	0.100
1	161 050 228	0.231
1 1/4	161 050 229	0.240
1 1/2	161 050 230	0.463
2	161 050 231	0.692

d [inch]	D [mm]	L [mm]	L1 [mm]	L2 [mm]	L3 max [mm]	L4 [mm]	G [inch]	s [mm]	Diameter of bore in tank side [mm]
1/2	56	89	67	11	30	16	1"	46	35
3/4	65	97	72	12	32	19	1 1/4"	50	43
1	70	103	75	12	33	22	1 1/2"	60	49
1 1/4	95	111	78	12	32	26	2"	80	61
1 1/2	95	119	82	13	32	31	2 1/4"	80	67
2	115	131	87	13	33	38	2 3/4"	95	83

Saddles

21 117

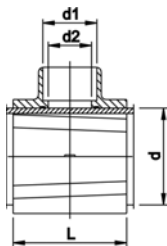

Saddle single branch (rubber gasket joint to main)

Model:

- Outlet with solvent cement socket, BS Inch
- Top saddle with NBR rubber gasket

d1-d	PN	Code Code	kg	L [mm]	
1 1/4 - 3"	10	161 117 055		106	
1 1/2 - 3"	10	161 117 056		106	
2 - 3"	10	161 117 057	0.767	106	
1 1/4 - 4"	10	161 117 065		106	
1 1/2 - 4"	10	161 117 066		106	
2 - 4"	10	161 117 067	0.930	106	
1 1/4 - 6"	10	161 117 095		120	
1 1/2 - 6"	10	161 117 096		120	
2 - 6"	10	161 117 097	1.364	120	

21 137

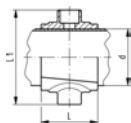

















Saddle double branch (rubber gasket joint to main)

Model:

- Top saddle with NBR rubber gasket
- Outlet with solvent cement socket, BS Inch
- Allowance should be made for a possible weakening effect on the main of the two diametrically opposed tapings. Particular attention should therefore be given to the class of pipe used in relation to the expected maximum working pressures.

d-d [inch]	PN	Code Code	kg	L [mm]	L1 [mm]
1 ¼ - 3	10	161 137 055		106	88
1 ½ - 3	10	161 137 056		106	88
2 - 3	10	161 137 057	0.851	106	88
1 ¼ - 4	10	161 137 065		106	101
1 ½ - 4	10	161 137 066		106	101
2 - 4	10	161 137 067	0.954	106	101
1 ¼ - 6	10	161 137 095		120	121
1 ½ - 6	10	161 137 096		120	121
2 - 6	10	161 137 097	1.332	120	121

PVC-U metric

		Page
	Pipes	32
	Pressure Pipes	37
	Fittings for solvent cement jointing	40
	Adaptor fittings	50
	Threaded fittings	57
	Flange adaptors	61
	Unions for solvent cement jointing	64
	Adaptor unions	67
	Union Ends	73
	Union bushes	79
	Union nuts	80
	Seals	81
	Tank adaptors	82
	Branch and tapping saddles	84
	POLY16 Plus CLAMP SADDLES	86
	Ball valves 546	90



Spare Parts Ball Valve Type 546

105



Ball Valves 375

112



Ball Valve Coloro

115



Ball Valves 543

119



Metering ball valve 323

132



Linear ball valves

134



Laboratory ball cock 322

135



Diaphragm valves

136



Angle seat valves

158



Angle seat check valves

159



Ball check valves

161



Cone check valves

164



Cone check valves

166



Process control valves

173



Wafer check valves

176









Strainers

180



Screen assemblies

183

	Inspection glass	185
	Process control valves	186
	Variable area flow meters	190
	Variable area flow meters accessories	198
	Integral Systems ProcessPro: Flow	199
		

Pipes

61 01 71

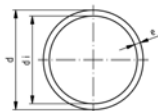

Pipe PVC-U grey Series S6.3 SDR13.6 nominal pressure PN16

Model:

- Material: PVC-U, Polyvinylchloride unplasticised DIN 8061
- Colour: RAL 7011 - dark-grey
- Dimension: DIN EN ISO 15493, DIN 8062
- Pipe length: 5m, with plain ends
- Minimum order quantity: 1 length

d [mm]	Size (NB) [inch]	PN	Code	e [mm]	di [mm]	Weight [kg/m]
12		16	161 017 104	1.0	10.0	0.055
16		16	161 017 105	1.2	13.6	0.090
20		16	161 017 106	1.5	17.0	0.137
25		16	161 017 107	1.9	21.2	0.212
32		16	161 017 108	2.4	27.2	0.342
40		16	161 017 109	3.0	34.0	0.525
50		16	161 017 110	3.7	42.6	0.809
63		16	161 017 111	4.7	53.6	1.290
75	2 ½	16	161 017 112	5.6	58.2	1.820
90		16	161 017 113	6.7	76.6	2.610
110		16	161 017 114	8.1	93.8	3.900
125		16	161 017 115	9.2	106.6	5.010
140	5	16	161 017 116	10.3	119.4	6.270
160		16	161 017 117	11.8	136.4	8.170

61 01 71

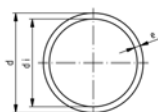

Pipe PVC-U grey Series S4 SDR9 nominal pressure PN16

Model:

- Material: PVC-U, Polyvinylchloride unplasticised DIN 8061
- Colour: RAL 7011 - dark-grey
- Dimension: DIN EN ISO 15493, DIN 8062
- Pipe length: 5m, with plain ends
- **Increased wall thickness for industrial use**
- Minimum order quantity: 1 length

d [mm]	PN	Code	e [mm]	di [mm]	Weight [kg/m]
6	16	161 017 126	1.0	4.0	0.025
8	16	161 017 127	1.0	6.0	0.035
10	16	161 017 128	1.2	7.6	0.053
12	16	161 017 129	1.4	9.2	0.073
16	16	161 017 130	1.8	12.4	0.123
20	16	161 017 131	2.3	15.4	0.196
25	16	161 017 132	2.8	19.4	0.294
32	16	161 017 133	3.6	24.8	0.482
40	16	161 017 134	4.5	31.0	0.750
50	16	161 017 135	5.6	38.8	1.160
63	16	161 017 136	7.0	49.0	1.820
75	16	161 017 137	8.4	58.2	2.600
90	16	161 017 138	10.0	70.0	3.700
110	16	161 017 139	12.3	85.4	5.560

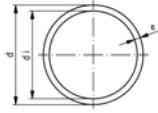

Pipe PVC-U grey Series S10 SDR21 nominal pressure PN10

Model:

- Material: PVC-U, Polyvinylchloride unplasticised DIN 8061
- Colour: RAL 7011 - dark-grey
- Dimension: DIN EN ISO 15493, DIN 8062
- Pipe length: 5m, with plain ends
- Minimum order quantity: 1 length

d [mm]	PN	Code	e [mm]	di [mm]	Weight [kg/m]
25	10	161 017 082	1.5	22.0	0.174
32	10	161 017 083	1.8	28.4	0.264
40	10	161 017 084	1.9	36.2	0.350
50	10	161 017 085	2.4	45.2	0.552
63	10	161 017 086	3.0	57.0	0.854
75	10	161 017 087	3.6	67.8	1.220
90	10	161 017 088	4.3	81.4	1.750
110	10	161 017 089	5.3	99.4	2.610
125	10	161 017 090	6.0	113.0	3.340
140	10	161 017 091	6.7	126.6	4.180
180	10	161 017 093	8.6	162.8	6.880
200	10	161 017 094	9.6	180.8	8.510
225	10	161 017 095	10.8	203.4	10.800
250	10	161 017 096	11.9	226.2	13.200
280	10	161 017 097	13.4	253.2	16.000
315	6	161 017 098	15.0	285.0	20.900

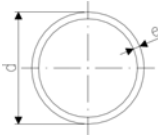

Pipe PVC-U grey SDR34.3 nominal pressure PN6

Model:

- Material: PVC-U, Polyvinylchloride unplasticised DIN 8061
- Colour: RAL 7011 - dark-grey
- Dimension: DIN EN ISO 15493, DIN 8062
- Pipe length: 5m, with plain ends
- Minimum order quantity: 1 length

d [mm]	PN	Code	e [mm]	di [mm]	Weight [kg/m]
50	6	161 017 060	1.8	46.4	0.422
63	6	161 017 061	1.9	59.2	0.562
75	6	161 017 062	2.2	70.6	0.782
90	6	161 017 063	2.7	84.6	1.130
110	6	161 017 064	3.2	103.6	1.640
125	6	161 017 065	3.7		
140	6	161 017 066	4.1	131.8	2.650
160	6	161 017 067	4.7	150.6	3.440
180	6	161 017 068	5.3	169.4	4.370
200	6	161 017 069	5.9	188.2	5.370
225	6	161 017 070	6.6	211.6	6.760
250	6	161 017 071	7.3	235.4	8.310
315	6	161 017 072	9.2	296.6	13.200
355	6	161 017 073	10.4	334.2	16.700
400	6	161 017 074	11.7	376.6	21.100

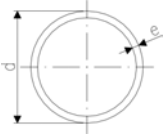

Pipe PVC-U grey SDR51 nominal pressure PN4

Model:

- Material: PVC-U, Polyvinylchloride unplasticised DIN 8061
- Colour: RAL 7011 - dark-grey
- Dimension: DIN EN ISO 15493, DIN 8062
- Pipe length: 5m, with plain ends
- Minimum order quantity: 1 length

d [mm]	PN	Code	e [mm]	di [mm]	Weight [kg/m]
75	4	161 017 037	1.8	71.4	0.642
90	4	161 017 038	1.8	86.4	0.774
110	4	161 017 039	2.2	105.6	1.160
125	4	161 017 040	2.5	120.0	1.480
140	4	161 017 041	2.8	134.4	1.840
160	4	161 017 042	3.2	153.6	2.410
180	4	161 017 043	3.6	172.8	3.020
200	4	161 017 044	4.0	192.0	3.700
225	4	161 017 045	4.5	216.0	4.700
250	4	161 017 046	4.9	240.2	5.650
280	4	161 017 047	5.5	269.0	7.110
315	4	161 017 048	6.2	302.6	9.020

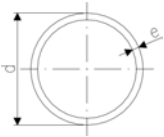

DEKADUR-Vent Pipes PVC-U

Model:

- Material: PVC-U
- Flame retardant acc. DIN 4102 B1 **
- Colour: RAL 7011 - dark-grey
- Dimension: acc. DIN 8062
- Pipe length: 5m, with plain ends

Note:

* Dimensional variations of wall thickness not according to DIN 8062

** up to wallthickness 3,2mm

d [mm]	Code	kg/m	e [mm]
110	324 110 000	0.950	1.8
125	324 125 000	1.080	1.8
140	324 140 000	1.210	1.8
160	324 160 000	1.390	1.8
180	324 180 000	1.570	1.8
200	324 200 000	1.740	1.8
225	324 225 000	1.960	1.8
250	324 250 000	2.400	2.0
280	324 280 000	3.110	2.3
315	324 315 000	3.780	2.5
355	324 355 000	4.870	2.9
400	324 400 000	6.100	3.2
450	324 450 000	7.650	3.6
500	324 500 000	9.370	4.0
160	324 160 001	1.910	2.5
* 180	324 180 001	2.150	2.5

table continued next page

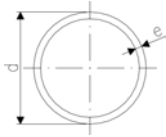

d [mm]	Code	kg/m	e [mm]
* 200	324 200 001	2.390	2.5
* 210	324 210 000	2.954	3.0
* 225	324 225 001	2.970	2.8
* 250	324 250 002	3.420	2.9
* 260	324 260 000	3.668	3.0
* 280	324 280 001	3.720	2.9
* 315	324 315 001	4.320	2.9
* 355	324 355 001	7.600	4.4
* 400	324 400 001	9.300	5.0
* 450	324 450 001	11.710	5.6
* 500	324 500 001	13.400	5.6
* 600	324 600 000	14.010	5.0



Pipe PVC-U transparent Series S6.25 SDR13.5 nominal pressure PN16

Model:

- Material: PVC-U, Polyvinylchloride unplasticised DIN 8061
- Colour: transparent
- Dimension: DIN EN ISO 15493, DIN 8062
- Pipe length: 5m, with plain ends
- The material used fulfills the requirements of DIN 8061 in all aspects except longterm pressure test
- Minimum order quantity: 1 length

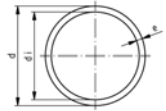

d [mm]	PN	Code	e [mm]	di [mm]	Weight [kg/m]
12	16	192 017 104	1.0	10.0	0.055
16	16	192 017 105	1.2	13.6	0.090
20	16	192 017 106	1.5	17.0	0.137
25	16	192 017 107	1.9	21.2	0.212
32	16	192 017 108	2.4	27.2	0.342
40	16	192 017 109	3.0	34.0	0.525
50	16	192 017 110	3.7	42.6	0.809
63	16	192 017 111	4.7	53.6	1.290



Pipe PVC-U transparent Series S10 SDR21 nominal pressure PN10

Model:

- Material: PVC-U, Polyvinylchloride unplasticised DIN 8061
- Colour: transparent
- Dimension: DIN EN ISO 15493, DIN 8062
- Pipe length: 5m, with plain ends
- Minimum order quantity: 1 length

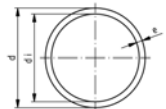

d [mm]	PN	Code	e [mm]	di [mm]	Weight [kg/m]
25	10	192 017 082	1.5	22.0	0.174
32	10	192 017 083	1.8	28.4	0.264
40	10	192 017 084	1.9	36.2	0.366
50	10	192 017 085	2.4	45.2	0.552
63	10	192 017 086	3.0	57.0	0.854

table continued next page

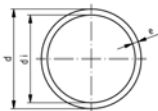

d [mm]	PN	Code	e [mm]	di [mm]	Weight [kg/m]
75	10	192 017 087	3.6	67.8	1.220
90	10	192 017 088	4.3	81.4	1.750
110	10	192 017 089	5.3	99.4	2.610



Pipe PVC-U transparent Series S16.7 SDR34.3 nominal pressure PN6

Model:

- Material: PVC-U, Polyvinylchloride unplasticised DIN 8061
- Colour: transparent
- Dimension: DIN EN ISO 15493, DIN 8062
- Pipe length: 5m, with plain ends
- The material used fulfills the requirements of DIN 8061 in all aspects except longterm pressure test
- Minimum order quantity: 1 length

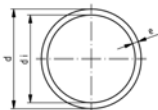

d [mm]	PN	Code	e [mm]	di [mm]	Weight [kg/m]
50	6	192 017 060	1.8	46.4	0.422
160	6	192 017 080	4.7	150.6	3.440



Pipe PVC-U transparent Series S25 SDR51 nominal pressure PN4

Model:

- Material: PVC-U, Polyvinylchloride unplasticised DIN 8061
- Colour: transparent
- Dimension: DIN EN ISO 15493, DIN 8062
- Pipe length: 5m, with plain ends
- The material used fulfills the requirements of DIN 8061 in all aspects except longterm pressure test
- Minimum order quantity: 1 length

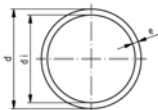

d [mm]	PN	Code	e [mm]	di [mm]	Weight [kg/m]
63	4	192 017 036	1.8	59.4	0.532
75	4	192 017 037	1.8	71.4	0.642
90	4	192 017 038	1.8	86.4	0.774
110	4	192 017 039	2.2	105.6	1.160
125	4	192 017 040	2.5	120.0	1.480
140	4	192 017 041	2.8	134.4	1.840
160	4	192 017 042	3.2	153.6	2.410
200	4	192 017 044	4.0	192.0	3.700
225	4	192 017 045	4.5	216.0	5.650
250	4	192 017 046	4.9	240.2	5.650
280	4	192 017 047	5.5	269.0	7.600

Pressure Pipes

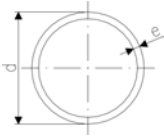

Pipes PVC-U, red L-HP

Model:

- Material: PVC-U
- Dimension: DIN 8061 / 8062
- food grade*
- Colour: red (similar RAL 2002)
- Pipe length: 5m, with plain ends

Note:

* Approved for food contact
Approval on request

d [mm]	Code	kg/m	e [mm]
16	325 016 000	0.123	1.8
20	325 020 000	0.196	2.3
25	325 025 000	0.212	2.8
32	325 032 003	0.342	2.4
40	325 040 003	0.525	3.0
50	325 050 003	0.809	3.7
63	325 063 003	1.290	4.7
75	325 075 002	1.820	5.6
90	325 090 002	2.610	6.7
110	325 110 003	3.900	8.2

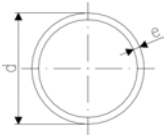

DEKADUR-Pressure Pipes PVC-U SDR 34,4, nominal pressure PN 6

Model:

- Material: PVC-U
- Dimension: acc. DIN 8062
- Colour: RAL 3020 red (troisdorfred)
- Pipe length: 5m, with plain ends

d [mm]	Code	kg/m	e [mm]
110	325 110 000	1.640	3.2

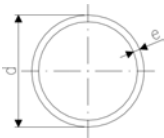

DEKADUR-Pressure Pipes PVC-U SDR 51, nominal pressure PN 4

Model:

- Material: PVC-U
- Dimension: acc. DIN 8062
- Colour: RAL 3020 red (troisdorfred)
- Pipe length: 5m, with plain ends

d [mm]	Code	kg/m	e [mm]
160	325 160 000	2.410	3.2
315	325 315 000	9.020	6.2

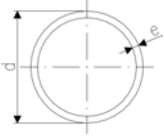

Pipes PVC-U, red SDR 21, nominal pressure PN 10

Model:

- Material: PVC-U
- Dimension: acc. DIN 8062
- Colour: RAL 3020 red (troisdorfred)
- Pipe length: 5m, with plain ends

d [mm]	Code	kg/m	e [mm]
32	325 032 000	0.276	1.9
40	325 040 000	0.350	1.9
50	325 050 001	0.552	2.4
63	325 063 000	0.854	3.0
75	325 075 000	1.222	3.6
90	325 090 000	1.750	4.3
110	325 110 001	2.610	5.3
140	325 140 000	4.180	6.7
160	325 160 001	5.470	7.7
225	325 225 000	10.800	10.8

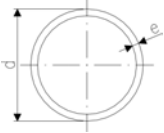

Pipes PVC-U, red SDR 13,6, nominal pressure PN 16

Model:

- Material: PVC-U
- Dimension: acc. DIN 8062
- Colour: RAL 3020 red (troisdorfred)
- Pipe length: 5m, with plain ends

d [mm]	Code	kg/m	e [mm]
12	325 012 000	0.055	1.0
16	325 016 001	0.090	1.2
20	325 020 001	0.137	1.5
25	325 025 002	0.212	1.9
32	325 032 001	0.342	2.4
40	325 040 001	0.525	3.0
50	325 050 000	0.809	3.7
63	325 063 001	1.290	4.7
75	325 075 001	1.820	5.6
90	325 090 001	2.610	6.7
110	325 110 002	3.856	8.2

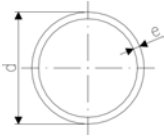

Pipes PVC-U, red
SDR 9, High Performance Nominal Pressure PN16

Model:

- Material: PVC-U
- Dimension: acc. DIN 8062
- Colour: RAL 3020 red (troisdorfred)
- Pipe length: 5m, with plain ends

d [mm]	Code	kg/m	e [mm]
10	325 010 000	0.053	1.2
16	325 016 002	0.123	1.8
20	325 020 002	0.196	2.3
25	325 025 001	0.294	2.8
32	325 032 002	0.482	3.6
40	325 040 002	0.750	4.5
50	325 050 002	1.160	5.6
63	325 063 002	1.820	7.0

Fittings for solvent cement jointing

21 00 01

Bend 90° PVC-U metric

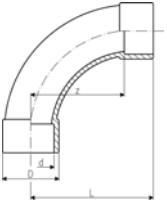

d [mm]	d [inch]	PN	Code	kg	z [mm]	D [mm]	L [mm]
20		16	721 000 106	0.029	40	27	56
25		16	721 000 107	0.049	50	33	69
32		16	721 000 108	0.074	64	38	86
40		16	721 000 109	0.121	80	47	106
50		16	721 000 110	0.298	100	61	131
63		16	721 000 111	0.516	126	76	164
75	2 ½	16	721 000 112	0.798	150	90	194
90		16	721 000 113	1.373	180	108	231
110		16	721 000 114	2.699	220	137	281
140	5	16	721 000 116	5.204	280	168	356
160		16	721 000 117	8.298	320	192	406

21 01 01

Bend 90° short pattern PVC-U metric

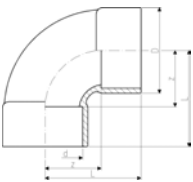

d [mm]	PN	Code	kg	z [mm]	D [mm]	L [mm]
225	10	721 010 120	7.561	168	256	287
280	10	721 010 122	16.987	210	318	357
315	6	721 010 123	21.567	237	356	402
400	6	721 010 125	30.000	300	442	521

21 10 01

Elbow 90° PVC-U metric

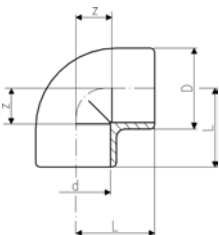

d [mm]	d [inch]	PN	Code	kg	z [mm]	D [mm]	L [mm]
6		16	721 100 101	0.004	4	11	16
8		16	721 100 102	0.004	5	13	17
10		16	721 100 103	0.004	6	14	18
12		16	721 100 104	0.006	7	17	19
16		16	721 100 105	0.007	9	21	23
20		16	721 100 106	0.012	11	25	27
25		16	721 100 107	0.024	14	32	33
32		16	721 100 108	0.043	17	40	39
40		16	721 100 109	0.062	23	47	49
50		16	721 100 110	0.110	26	59	57
63		16	721 100 111	0.209	33	73	71
75	2 ½	16	721 100 112	0.330	40	87	83
90		16	721 100 113	0.582	46	105	97
110		16	721 100 114	1.009	55	128	116

table continued next page

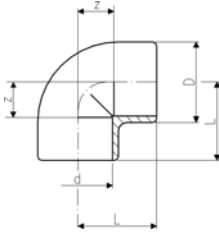

d [mm]	d [inch]	PN	Code	kg	z [mm]	D [mm]	L [mm]
125		16	721 100 115	1.522	63	146	131
140	5	16	721 100 116	1.945	70	162	146
160		16	721 100 117	2.873	80	185	166
200		10	721 100 119	4.446	101	225	207
225		10	721 100 120	5.989	114	252	233
250		10	721 100 121	10.014	131	282	263

21 10 03



PRO-FIT Elbows 90°, PVC-U metric

Model:

- Outlet: A = Solvent cemented socket metric
- Outlet: B = Solvent cemented spigot in combination with reducing socket metric
- Direct connection from fitting to fitting allowing shortest possible overall length

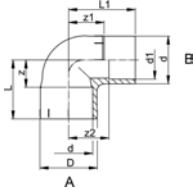

d [mm]	d1 [mm]	PN	Code	kg	z [mm]	z1 [mm]	z2 [mm]	D [mm]	L [mm]	L1 [mm]
20	16	16	721 100 306	0.011	11	16	18	25	27	32
25	20	16	721 100 307	0.020	14	18	21	31	33	37
32	25	16	721 100 308	0.038	17	22	25	38	39	44
40	32	16	721 100 309	0.069	23	30	34	47	49	56
50	40	16	721 100 310	0.122	26	36	41	58	57	67
63	50	16	721 100 311	0.237	33	45	52	73	71	83

21 15 01



Elbow 45° PVC-U metric

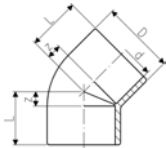

d [mm]	d [inch]	PN	Code	kg	z [mm]	D [mm]	L [mm]
16		16	721 150 105	0.008	5	21	19
20		16	721 150 106	0.011	5	25	21
25		16	721 150 107	0.017	6	31	25
32		16	721 150 108	0.028	8	38	30
40		16	721 150 109	0.049	10	47	36
50		16	721 150 110	0.086	12	59	43
63		16	721 150 111	0.160	14	73	52
75	2 ½	16	721 150 112	0.253	17	87	61
90		16	721 150 113	0.430	20	105	71
110		16	721 150 114	0.750	25	127	86
125		16	721 150 115	1.193	28	146	97
140	5	16	721 150 116	1.570	32	162	108
160		16	721 150 117	2.280	36	185	122
200		10	721 150 119	3.288	43	225	149
225		10	721 150 120	4.191	49	250	168
250		10	721 150 121	7.115	60	282	192
280		10	721 150 122	10.340	66	318	213
315		6	721 150 123	14.292	74	356	239
400		6	721 150 125	25.268	94	442	302

21 15 03

PRO-FIT Elbows 45°, PVC-U metric

Model:

- Outlet: A = Solvent cemented socket metric
- Outlet: B = Solvent cemented spigot in combination with reducing socket metric
- Direct connection from fitting to fitting allowing shortest possible overall length

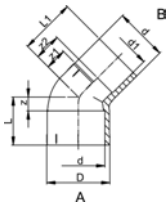

d [mm]	d1 [mm]	PN	Code	kg	z [mm]	z1 [mm]	z2 [mm]	D [mm]	L [mm]	L1 [mm]
20	16	16	721 150 306	0.009	5	9	11	25	21	25
25	20	16	721 150 307	0.015	6	11	14	31	25	30
32	25	16	721 150 308	0.027	8	13	16	38	30	35
40	32	16	721 150 309	0.053	10	17	21	47	36	43
50	40	16	721 150 310	0.090	12	18	23	58	43	49
63	50	16	721 150 311	0.175	14	23	30	73	52	61

21 20 01

Tee 90° equal PVC-U metric

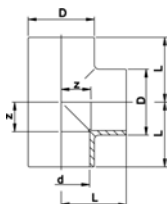

d [mm]	d [inch]	PN	Code	kg	z [mm]	D [mm]	L [mm]
6		16	721 200 101	0.004	4	11	16
8		16	721 200 102	0.008	5	13	17
10		16	721 200 103	0.008	6	16	18
12		16	721 200 104	0.011	7	19	19
16		16	721 200 105	0.011	9	21	23
20		16	721 200 106	0.019	11	25	27
25		16	721 200 107	0.028	14	31	33
32		16	721 200 108	0.055	17	38	39
40		16	721 200 109	0.100	23	48	49
50		16	721 200 110	0.156	26	58	57
63		16	721 200 111	0.291	33	73	71
75	2 ½	16	721 200 112	0.476	39	87	83
90		16	721 200 113	0.824	46	105	97
110		16	721 200 114	1.411	55	127	116
125		16	721 200 115	2.521	66	151	135
140	5	16	721 200 116	3.487	71	169	147
160		16	721 200 117	4.982	81	193	167
200		10	721 200 119	5.780	101	225	207
225		10	721 200 120	9.105	114	256	233
250		10	721 200 121	14.350	132	282	263
280		10	721 200 122	19.541	152	318	298
315		6	721 200 123	27.254	168	356	332
400		6	721 200 125	35.000	214	442	420

21 20 03



PRO-FIT Tees 90° equal, PVC-U metric

Model:

- Outlet: A = Solvent cemented socket metric
- Outlet: B = Solvent cemented spigot in combination with reducing socket metric
- Direct connection from fitting to fitting allowing shortest possible overall length

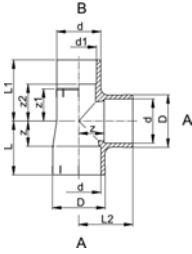

d [mm]	d1 [mm]	PN	Code	kg	z [mm]	z1 [mm]	z2 [mm]	D [mm]	L [mm]	L1 [mm]	L2 [mm]
20	16	16	721 200 306	0.017	11	17	19	25	27	33	27
25	20	16	721 200 307	0.022	14	19	22	31	33	38	33
32	25	16	721 200 308	0.051	17	24	27	38	39	46	39
40	32	16	721 200 309	0.098	23	30	34	47	47	56	49
50	40	16	721 200 310	0.164	26	36	41	58	57	67	57
63	50	16	721 200 311	0.329	33	45	52	73	71	83	71

21 20 01



Tee 90° reducing PVC-U metric

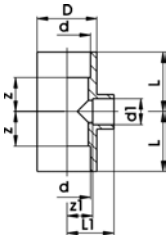

d [mm]	d1 [mm]	PN	d-d [inch]	Code	kg	z [mm]	z1 [mm]	D [mm]	L [mm]	L1 [mm]
25	20	16	-	721 200 134	0.038	14	14	33	33	30
32	20	16	-	721 200 141	0.061	17	17	41	39	33
32	25	16	-	721 200 138	0.063	17	17	41	39	36
40	20	16	-	721 200 155	0.103	23	23	50	49	39
40	25	16	-	721 200 151	0.107	23	23	50	49	42
40	32	16	-	721 200 147	0.109	23	23	50	49	45
50	20	16	-	721 200 009	0.179	28	28	62	59	44
50	25	16	-	721 200 010	0.183	28	28	62	59	47
50	32	16	-	721 200 164	0.189	28	28	62	59	50
50	40	16	-	721 200 161	0.208	28	28	62	59	54
63	25	16	-	721 200 011	0.332	35	34	77	73	53
63	32	16	-	721 200 178	0.336	35	34	77	73	56
63	40	16	-	721 200 174	0.347	35	34	77	73	60
63	50	16	-	721 200 170	0.354	35	34	77	73	65
75	32	16	-	721 200 181	0.535	40	41	92	84	63
75	40	16	-	721 200 182	0.555	40	41	92	84	67
75	50	16	-	721 200 183	0.541	40	41	92	84	72
75	63	16	-	721 200 184	0.570	40	41	92	84	79
90	32	16	-	721 200 142	0.855	46	55	110	97	77
90	50	16	-	721 200 144	0.907	46	55	110	97	86
90	63	16	-	721 200 145	0.931	46	55	110	97	93
90	75	16	-	721 200 146	0.959	46	55	110	97	99
110	32	16	-	721 200 135	1.441	56	67	133	117	89
110	50	16	-	721 200 136	1.471	56	67	133	117	98
110	63	16	-	721 200 132	1.522	56	65	133	117	103
110	90	16	-	721 200 137	1.634	56	65	133	117	116
125	50	16	-	721 200 139	1.970	64	75	151	133	106
125	90	16	-	721 200 140	2.200	64	75	151	133	126
140	50	16	-	721 200 148	3.235	72	82	172	148	113
140	75	16	5 - 2 ½	721 200 149	3.319	72	78	172	148	122

table continued next page

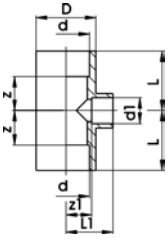

d [mm]	d1 [mm]	PN	d-d [inch]	Code	kg	z [mm]	z1 [mm]	D [mm]	L [mm]	L1 [mm]
140	110	16	-	721 200 150	3.422	72	74	172	148	135
160	110	16	-	721 200 152	4.305	81	81	192	167	142
200	110	10	-	721 200 153	8.782	107	131	232	213	192
200	160	10	-	721 200 154	8.036	107	106	232	213	192
225	110	10	-	721 200 156	10.619	120	143	257	239	204
225	160	10	-	721 200 157	9.707	120	119	257	239	205
250	160	10	-	721 200 159	14.520	132	151	282	263	237
250	200	10	-	721 200 162	12.213	132	131	282	263	237
280	160	10	-	721 200 165	18.402	120	180	318	266	266
280	225	10	-	721 200 167	16.145	120	148	318	266	268
315	160	6	-	721 200 169	22.189	120	197	356	284	283
315	225	6	-	721 200 172	20.154	120	165	356	284	284
400	225	6	-	721 200 176	40.000	163	258	442	369	377
400	315	6	-	721 200 180	35.000	163	213	442	369	377

21 25 01

Tee 45° PVC-U metric

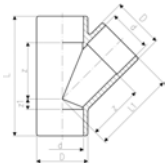

d [mm]	d1 [inch]	PN	Code	kg	z [mm]	z1 [mm]	D [mm]	L [mm]	L1 [mm]
10		10	721 250 103	0.013	18	4	16	46	30
12		10	721 250 104	0.014	21	4	18	49	33
16		10	721 250 105	0.022	25	5	23	58	39
20		10	721 250 106	0.035	30	6	28	68	46
25		10	721 250 107	0.057	36	9	33	83	55
32		10	721 250 108	0.096	45	10	41	99	67
40		10	721 250 109	0.159	56	10	50	118	82
50		10	721 250 110	0.265	66	12	60	140	97
63		10	721 250 111	0.439	85	14	74	175	123
75	2 ½	6	721 250 112	0.816	101	18	91	207	145
90		6	721 250 113	1.275	122	20	107	245	173
110		6	721 250 114	2.579	149	27	134	298	210
125		6	721 250 115	3.616	167	30	147	335	236
145	5	6	721 250 116	5.628	190	34	168	376	266
160		6	721 250 117	7.187	213	41	190	428	300
200		6	721 250 119	12.314	265	48	232	527	372
225		6	721 250 120	15.735	296	54	260	590	416
250		6	721 250 121	20.350	330	60	286	654	462

21 30 01

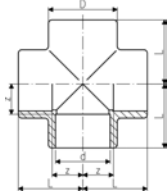
Cross PVC-U metric

d [mm]	d [inch]	PN	Code	kg	z [mm]	D [mm]	L [mm]
10		16	721 300 103	0.009	7	16	19
12		16	721 300 104	0.010	8	18	20
16		16	721 300 105	0.020	10	23	24
20		16	721 300 106	0.036	11	29	27
25		16	721 300 107	0.054	14	35	33
32		16	721 300 108	0.092	17	43	39
40		16	721 300 109	0.155	23	52	49
50		16	721 300 110	0.259	28	63	59
63		16	721 300 111	0.482	34	79	72
75	2 ½	10	721 300 112	0.725	40	92	83
90		10	721 300 113	1.221	48	106	97
110		10	721 300 114	2.111	58	128	117

21 91 01

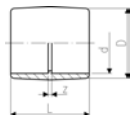
Socket equal PVC-U metric¹ Socket d355 and d400 fabricated from pipe

d [mm]	d [inch]	PN	Code	kg	z [mm]	D [mm]	L [mm]
6		16	721 910 101	0.004	3	12	27
8		16	721 910 102	0.005	3	14	27
10		16	721 910 103	0.004	3	16	27
12		16	721 910 104	0.004	3	19	27
16		16	721 910 105	0.007	3	22	31
20		16	721 910 106	0.010	3	26	35
25		16	721 910 107	0.015	3	32	41
32		16	721 910 108	0.027	3	39	47
40		16	721 910 109	0.045	3	48	55
50		16	721 910 110	0.063	3	58	65
63		16	721 910 111	0.119	3	73	79
75	2 ½	16	721 910 112	0.188	4	87	92
90		16	721 910 113	0.328	5	105	107
110		16	721 910 114	0.554	6	128	128
125		16	721 910 115	0.825	7	142	145
140	5	16	721 910 116	1.118	7	162	159
160		16	721 910 117	1.540	8	183	180
200		10	721 910 119	2.559	9	221	221
225		10	721 910 120	3.519	10	253	248
250		10	721 910 121	5.394	16	284	284
280		10	721 910 122	8.312	16	321	314
315		6	721 910 123	8.300	16	356	348
¹ 355		6	721 910 124	10.706	68	377	454
¹ 400		6	721 910 125	11.326	73	425	505

52 91 01

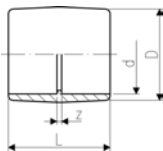
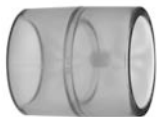
Socket equal PVC-U transparent metric

d [mm]	PN	Code	kg	z [mm]	D [mm]	L [mm]
16	16	752 910 105	0.009	3	23	31
20	16	752 910 106	0.012	3	27	35
25	16	752 910 107	0.016	3	32	41
32	16	752 910 108	0.027	3	40	47
40	16	752 910 109	0.061	3	52	55
50	16	752 910 110	0.068	3	60	65
63	16	752 910 111	0.116	3	75	79

21 90 09

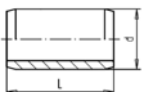
Barrel nipple PVC-U metric

d [mm]	d [inch]	PN	Code	kg	L [mm]
16		16	721 900 905	0.002	28
20		16	721 900 906	0.005	32
25		16	721 900 907	0.009	38
32		16	721 900 908	0.015	44
40		16	721 900 909	0.027	52
50		16	721 900 910	0.050	62
63		16	721 900 911	0.092	76
75	2 ½	16	721 900 912	0.156	88
90		16	721 900 913	0.260	102
110		16	721 900 914	0.455	122
125		16	721 900 915	0.673	138
140	5	16	721 900 916	0.932	152
160		16	721 900 917	1.565	192
200		10	721 900 919	1.779	212
225		10	721 900 920	2.566	238

21 90 03

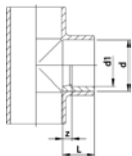

Reducing bush short PVC-U metric

Model:

- With solvent cement spigot and socket metric

d [mm]	d1 [mm]	PN	Code	kg	z [mm]	L [mm]
* 12	8	16	721 900 329	0.002	2	14
* 16	12	16	721 900 331	0.002	2	14
* 20	16	16	721 900 334	0.002	2	16
* 25	20	16	721 900 337	0.004	3	19
* 32	20	16	721 900 342	0.014	6	22
* 32	25	16	721 900 341	0.009	3	22
40	20	16	721 900 348	0.021	10	26
40	25	16	721 900 347	0.021	7	26
* 40	32	16	721 900 346	0.016	4	26
50	20	16	721 900 355	0.037	15	31
50	25	16	721 900 354	0.034	12	31
50	32	16	721 900 353	0.038	9	31
* 50	40	16	721 900 352	0.030	5	31
63	32	16	721 900 360	0.062	16	38
63	40	16	721 900 359	0.066	12	38
* 63	50	16	721 900 358	0.057	7	38
75	50	16	721 900 365	0.109	13	44
* 75	63	16	721 900 364	0.077	6	44
90	50	16	721 900 372	0.185	20	51
90	63	16	721 900 371	0.180	13	51
* 90	75	16	721 900 370	0.133	7	51
110	50	16	721 900 379	0.316	30	61
110	63	16	721 900 378	0.308	23	61
110	75	16	721 900 377	0.295	17	61
* 110	90	16	721 900 376	0.259	10	61
125	90	16	721 900 381	0.465	18	69
* 125	110	16	721 900 380	0.267	8	69
140	90	16	721 900 386	0.562	25	76
* 140	110	16	721 900 385	0.605	15	76
* 140	125	16	721 900 384	0.331	7	76
160	90	16	721 900 391	0.751	35	86
160	110	16	721 900 390	0.883	25	86
* 160	140	16	721 900 388	0.551	10	86
200	110	10	721 900 393	1.985	45	106
200	125	10	721 900 325	2.024	37	106
200	140	10	721 900 394	1.928	30	106
200	160	10	721 900 392	1.085	20	106
225	110	10	721 900 397	2.544	58	119
225	125	10	721 900 399	2.563	50	119
225	140	10	721 900 398	2.609	43	119
225	160	10	721 900 396	2.199	33	119
* 225	200	10	721 900 181	1.360	13	119
250	125	10	721 900 326	3.150	62	131
250	140	10	721 900 300	3.200	55	131
250	160	10	721 900 301	3.390	45	131
* 250	200	10	721 900 302	3.198	25	131
* 250	225	10	721 900 303	1.686	12	131

table continued next page

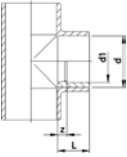

d [mm]	d1 [mm]	PN	Code	kg	z [mm]	L [mm]
280	140	10	721 900 307	4.157	69	148
280	160	10	721 900 308	4.170	59	148
280	200	10	721 900 304	4.577	40	146
* 280	225	10	721 900 305	4.409	27	146
* 280	250	10	721 900 306	2.515	15	146
315	160	6	721 900 313	5.188	77	166
315	200	6	721 900 309	5.480	57	166
315	225	6	721 900 310	5.968	45	164
315	250	6	721 900 311	6.481	33	164
315	280	6	721 900 312	3.651	17	164
355	315	6	721 900 315	5.792	20	184
400	250	6	721 900 319	11.528	75	206
400	280	6	721 900 320	11.366	60	206
400	315	6	721 900 321	13.006	42	206
* 400	355	6	721 900 322	7.524	22	206

21 91 03

Reducing bush long PVC-U metric

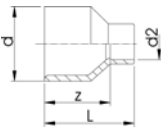

d [mm]	d2 [mm]	PN	Code	kg	z [mm]	L [mm]
8	6	16	721 910 323	0.003	15	27
10	6	16	721 910 326	0.003	15	27
10	8	16	721 910 325	0.003	15	27
20	16	16	721 910 334	0.009	21	35
25	20	16	721 910 337	0.015	25	41
32	25	16	721 910 341	0.025	30	49
40	32	16	721 910 346	0.043	36	58
50	40	16	721 910 352	0.074	44	70
63	50	16	721 910 358	0.148	54	85
75	63	16	721 910 364	0.211	62	100
90	75	16	721 910 370	0.335	74	118
140	110	16	721 910 385	0.808	111	172

21 91 09

PRO-FIT Reducing Bushes, PVC-U metric

Model:

- Outlet: A and B = Solvent cemented spigot in combination with reducing socket metric

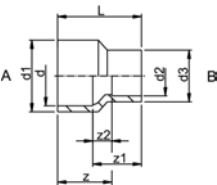

d [mm]	d1 [mm]	d2 [mm]	d3 [mm]	PN	Code	kg	z [mm]	z1 [mm]	z2 [mm]	L [mm]
10	14	8	12	16	721 910 903	0.003	15	15	3	27
12	16	8	12	16	721 910 905	0.004	18	18	6	30
12	16	10	16	16	721 910 906	0.004	18	18	6	30
16	20	10	16	16	721 910 908	0.003	21	19	7	33
16	20	12	16	16	721 910 909	0.004	21	19	7	33
20	25	12	16	16	721 910 910	0.008	25	21	9	37
20	25	16	20	16	721 910 911	0.008	25	23	9	39
25	32	12	16	16	721 910 912	0.014	30	23	11	42
25	32	16	20	16	721 910 913	0.015	30	26	12	44
25	32	20	25	16	721 910 914	0.017	30	27	11	46
32	40	16	20	16	721 910 915	0.025	36	28	14	50
32	40	20	25	16	721 910 916	0.026	36	30	14	52

table continued next page

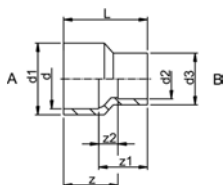

d [mm]	d1 [mm]	d2 [mm]	d3 [mm]	PN	Code	kg	z [mm]	z1 [mm]	z2 [mm]	L [mm]
32	40	25	32	16	721 910 917	0.031	36	33	14	55
40	50	20	25	16	721 910 918	0.045	44	34	18	60
40	50	25	32	16	721 910 919	0.052	44	37	18	63
40	50	32	40	16	721 910 920	0.058	44	40	18	66
50	63	25	32	16	721 910 921	0.092	54	42	23	73
50	63	32	40	16	721 910 922	0.098	54	45	23	76
50	63	40	50	16	721 910 923	0.111	54	49	23	80
63	75	32	40	16	721 910 924	0.127	62	46	24	84
63	75	40	50	16	721 910 925	0.139	62	50	24	88
63	75	50	63	16	721 910 926	0.167	62	55	24	93
75	90	40	50	16	721 910 927	0.224	74	56	30	100
75	90	50	63	16	721 910 928	0.253	74	61	30	105
75	90	63	75	16	721 910 929	0.265	74	68	30	112

21 96 01

Cap PVC-U metric

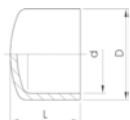

d [mm]	d [inch]	PN	Code	kg	D [mm]	L [mm]
12		16	721 960 104	0.004	19	15
16		16	721 960 105	0.005	23	21
20		16	721 960 106	0.008	27	24
25		16	721 960 107	0.013	33	28
32		16	721 960 108	0.020	40	32
40		16	721 960 109	0.029	47	38
50		16	721 960 110	0.051	59	45
63		16	721 960 111	0.094	74	56
75	2 ½	16	721 960 112	0.152	87	65
90		16	721 960 113	0.269	105	77
110		16	721 960 114	0.459	128	94
140	5	10	721 960 116	1.036	164	92
160		10	721 960 117	1.534	188	130
200		10	721 960 119	2.614	230	170
225		10	721 960 120	3.320	257	185
280		10	721 960 122	6.200	318	230
315		6	721 960 123	8.500	356	255

Adaptor fittings

21 10 02

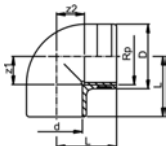

Elbow 90° PVC-U metric Rp

Model:

- With solvent cement socket metric and parallel female thread Rp
- Reinforcing ring stainless (A2)
- Connection to plastic or metal threads
- Do not use thread sealing pastes that are harmful to PVC-U
- Install with low mechanical stress and avoid large cyclic temperature changes

* without reinforcement, connection for plastic threads only

as long as stocks last

d [mm]	Rp [inch]	PN	Code	kg	z1 [mm]	z2 [mm]	D [mm]	L [mm]	
12	¼	16	721 100 204	0.010	7	7	20	19	
16	⅜	16	721 100 205	0.015	9	9	25	23	
20	½	16	721 100 206	0.023	13	11	30	27	
25	¾	16	721 100 207	0.035	16	15	35	33	
32	1	16	721 100 208	0.060	19	19	45	39	
40	1 ¼	16	721 100 209	0.122	23	27	55	50	
50	1 ½	16	721 100 210	0.187	27	36	62	58	
63	2	16	721 100 211	0.324	33	46	75	73	
* # 75	2 ½	10	721 100 212	0.455	40	56	90	84	
* # 90	3	10	721 100 213	0.786	48	68	108	99	
* # 110	4	10	721 100 214	1.259	58	82	132	119	

21 20 02

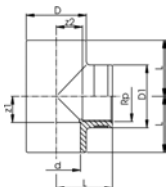

Tee 90° PVC-U metric Rp

Model:

- With solvent cement socket metric, branch with parallel female thread Rp
- Reinforcing ring stainless (A2)
- Connection to plastic or metal threads
- Do not use thread sealing pastes that are harmful to PVC-U
- Install with low mechanical stress and avoid large cyclic temperature changes

* without reinforcement, connection for plastic threads only

as long as stocks last

d [mm]	Rp [inch]	PN	Code	kg	z1 [mm]	z2 [mm]	D [mm]	D1 [mm]	L [mm]	
12	¼	16	721 200 204	0.015	7	7	17	20	19	
16	⅜	16	721 200 205	0.027	9	9	21	25	23	
20	½	16	721 200 206	0.029	11	13	26	30	29	
25	¾	16	721 200 207	0.043	14	15	32	35	33	
32	1	16	721 200 208	0.080	17	19	40	45	39	
40	1 ¼	16	721 200 209	0.134	23	26	47	55	49	
50	1 ½	16	721 200 210	0.212	27	36	59	59	59	
63	2	16	721 200 211	0.379	33	46	74	75	71	
* # 75	2 ½	10	721 200 212	0.635	40	56	92	92	84	
* # 90	3	10	721 200 213	1.095	48	68	110	110	99	
* # 110	4	10	721 200 214	1.697	58	82	133	132	119	

21 91 02

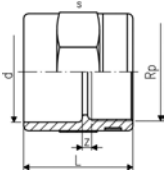

Adaptor socket PVC-U metric Rp

Model:

- With solvent cement socket metric and parallel female thread Rp
- Reinforcing ring stainless (A2)
- Connection to plastic or metal threads
- Do not use thread sealing pastes that are harmful to PVC-U
- Install with low mechanical stress and avoid large cyclic temperature changes

d [mm]	Rp [inch]	PN	Code	kg	z [mm]	L [mm]	s [mm]
12	¼	16	721 910 204	0.010	4	27	22
16	⅜	16	721 910 205	0.016	5	31	27
20	½	16	721 910 206	0.025	5	36	32
25	¾	16	721 910 207	0.032	5	40	36
32	1	16	721 910 208	0.057	5	45	46
40	1 ¼	16	721 910 209	0.087	5	51	55
50	1 ½	16	721 910 210	0.126	7	59	65
63	2	16	721 910 211	0.205	7	69	80

21 91 60

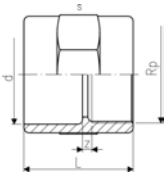

Adaptor socket PVC-U metric Rp

Model:

- With solvent cement socket metric and parallel female thread Rp
- Connection to plastic threads only
- Do not use thread sealing pastes that are harmful to PVC-U
- Install with low mechanical stress and avoid large cyclic temperature changes

d [mm]	Rp [inch]	PN	Code	kg	z [mm]	L [mm]	s [mm]
75	2 ½	10	721 916 012	0.220	7	82	90
90	3	10	721 916 013	0.365	9	94	110
110	4	10	721 916 014	0.536	9	110	130

21 91 42

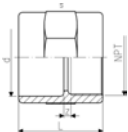

Adaptor socket PVC-U metric NPT

Model:

- With solvent cement socket metric and NPT (ASTM) taper female thread
- Connection to plastic threads only
- Do not use thread sealing pastes that are harmful to PVC-U
- Install with low mechanical stress and avoid large cyclic temperature changes

as long as stocks last

d [mm]	NPT [inch]	PN	Code	kg	z [mm]	L [mm]	s [mm]
20	½	10	721 914 206	0.021	5	35	32
25	¾	10	721 914 207	0.028	6	40	36
32	1	10	721 914 208	0.049	6	45	46
40	1 ¼	10	721 914 209	0.076	6	51	55
50	1 ½	10	721 914 210	0.110	10	59	65
63	2	10	721 914 211	0.175	10	69	80
# 75	2 ½	10	721 914 212	0.242	11	82	90
# 90	3	10	721 914 213	0.372	14	94	110
# 110	4	10	721 914 214	0.543	18	110	130

21 91 04

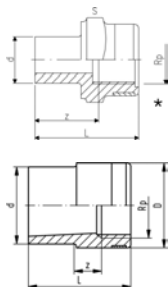

Reducing bush PVC-U metric Rp

Model:

- With solvent cement spigot metric and parallel female thread Rp
- Reinforcing ring stainless (A2)
- Connection to plastic or metal threads
- Do not use thread sealing pastes that are harmful to PVC-U
- Install with low mechanical stress and avoid large cyclic temperature changes

d [mm]	Rp [inch]	PN	Code	kg	z [mm]	D [mm]	L [mm]	s [mm]
* 12	1/4	16	721 910 404	0.007	0	20	27	22
20	3/8	16	721 910 434	0.014	7	25	35	
25	1/2	16	721 910 437	0.021	7	30	41	
32	3/4	16	721 910 441	0.032	15	35	48	
40	1	16	721 910 446	0.058	20	45	56	
50	1 1/4	16	721 910 452	0.097	20	55	66	
63	1 1/2	16	721 910 458	0.151	10	62	77	

21 90 04

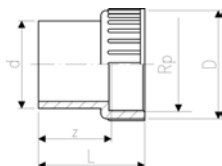

Adaptor bush equal PVC-U metric Rp

Model:

- With solvent cement spigot metric and parallel female thread Rp
- Connection to plastic threads only
- Do not use thread sealing pastes that are harmful to PVC-U
- Install with low mechanical stress and avoid large cyclic temperature changes

d [mm]	Rp [inch]	PN	Code	kg	z [mm]	D [mm]	L [mm]
20	1/2	10	721 900 406	0.012	22	28	37
25	3/4	10	721 900 407	0.018	25	34	41
32	1	10	721 900 408	0.035	29	42	48
40	1 1/4	10	721 900 409	0.063	34	52	56
50	1 1/2	10	721 900 410	0.097	40	62	61
63	2	10	721 900 411	0.170	49	77	74

21 91 05

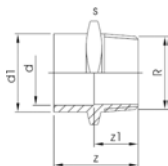

Adaptor socket nipple PVC-U metric R

Model:

- With solvent cement spigot/socket reducing metric and taper male thread R
- Do not use thread sealing pastes that are harmful to PVC-U
- Install with low mechanical stress and avoid large cyclic temperature changes

d [mm]	d1 [mm]	R [inch]	PN	Code	kg	z [mm]	z1 [mm]	s [mm]
12	16	3/8	16	721 910 555	0.010	35	23	27
16	20	1/2	16	721 910 556	0.016	42	28	32
20	25	3/4	16	721 910 557	0.023	47	31	36
25	32	1	16	721 910 558	0.040	54	35	46
32	40	1 1/4	16	721 910 559	0.061	60	38	55
40	50	1 1/2	16	721 910 560	0.094	66	40	65
50	63	2	16	721 910 561	0.164	78	47	80

21 91 07

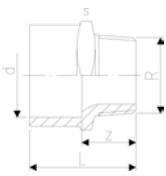

Adaptor bush equal PVC-U metric R

Model:

- With solvent cement socket metric and taper male thread R
- Do not use thread sealing pastes that are harmful to PVC-U
- Install with low mechanical stress and avoid large cyclic temperature changes

d [mm]	R [inch]	PN	d [inch]	Code	kg	z [mm]	L [mm]	s [mm]
16	3/8	16	3/8	721 910 705	0.011	20	34	27
20	1/2	16	1/2	721 910 706	0.018	24	40	32
25	3/4	16	3/4	721 910 707	0.025	25	44	36
32	1	16	1	721 910 708	0.039	28	50	46
40	1 1/4	16	1 1/4	721 910 709	0.061	31	57	55
50	1 1/2	16	1 1/2	721 910 710	0.092	32	63	65
63	2	16	2	721 910 711	0.161	38	76	80
75	2 1/2	10	2 1/2	721 910 712	0.227	42	86	90
90	3	10	3	721 910 713	0.389	46	97	110
110	4	10	4	721 910 714	0.572	53	114	130

21 91 35

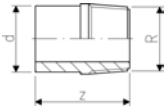

Adaptor nipple PVC-U metric R

Model:

- With solvent cement spigot metric and taper male thread R
- Do not use thread sealing pastes that are harmful to PVC-U
- Install with low mechanical stress and avoid large cyclic temperature changes

d [mm]	R [inch]	PN	Code	kg	z [mm]
16	3/8	10	721 913 505	0.006	31
20	1/2	10	721 913 506	0.010	35
25	3/4	10	721 913 507	0.017	40
32	1	10	721 913 508	0.026	46

21 91 31

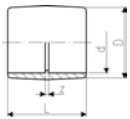

Adaptor socket PVC-U metric Inch/BS

Model:

- With solvent cement sockets metric and BS inch

d [mm]	d [inch]	PN	Code	kg	z [mm]	D [mm]	L [mm]
16	3/8	16	721 913 105	0.010	5	23	35
20	1/2	16	721 913 106	0.012	5	27	38
25	3/4	16	721 913 107	0.020	5	33	45
32	1	16	721 913 108	0.031	5	41	51
40	1 1/4	16	721 913 109	0.054	5	51	60
50	1 1/2	16	721 913 110	0.074	4	59	65
63	2	16	721 913 111	0.155	5	75	79
90	3	16	721 913 113	0.340	6	104	108
110	4	16	721 913 115	0.488	4	128	128



Adaptor Fitting PVC-U/stainless steel Rp

Model:

- Adaptor fitting PVC-U
- Adaptor fitting equally suitable as socket and spigot
- Stainless steel WN 1.4404 (3162) with parallel female thread Rp
- Gasket: O-ring EPDM No. 48 41 01

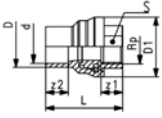

d	D	PN	Rp	Code	kg	z1	z2	D1	L	S
[mm]	[mm]		[inch]			[mm]	[mm]	[mm]	[mm]	[mm]
20	25	16	½	721 940 106	0.099	17.0	16.5	40	69.5	25
25	32	16	¾	721 940 107	0.175	19.0	19.0	50	83.2	30
32	40	16	1	721 940 108	0.267	22.0	22.5	59	95.5	36



Adaptor Fitting PVC-U/stainless steel R

Model:

- Adaptor fitting PVC-U
- Adaptor fitting equally suitable as socket and spigot
- Stainless steel with taper male thread R
- Gasket: O-ring EPDM No. 48 41 01

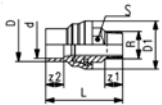

d	D	PN	R	Code	kg	z1	z2	D1	L	S
[mm]	[mm]		[inch]			[mm]	[mm]	[mm]	[mm]	[mm]
20	25	16	½	721 940 606	0.124	17.0	16.5	40	69.5	25
25	32	16	¾	721 940 607	0.220	19.0	19.0	50	83.2	30
32	40	16	1	721 940 608	0.335	22.0	22.5	59	95.5	36



Adaptor Fitting PVC-U/brass Rp

Model:

- Adaptor fitting PVC-U
- Adaptor fitting equally suitable as socket and spigot
- Brass with parallel female thread Rp
- Gasket: O-ring EPDM No. 48 41 01

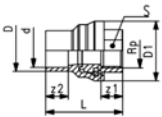

d	D	PN	Rp	Code	kg	z1	z2	D1	L	S
[mm]	[mm]		[inch]			[mm]	[mm]	[mm]	[mm]	[mm]
20	25	16	½	721 950 106	0.103	17.0	16.5	40	54.5	25
25	32	16	¾	721 950 107	0.181	18.5	19.0	50	65.2	30
32	40	16	1	721 950 108	0.279	21.5	22.5	59	76.5	36



Adaptor Fitting PVC-U/brass R

Model:

- Adaptor fitting PVC-U
- Adaptor fitting equally suitable as socket and spigot
- Brass with taper male thread R
- Gasket: O-ring EPDM No. 48 41 01

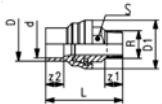

d	D	PN	R	Code	kg	z1	z2	D1	L	S
[mm]	[mm]		[inch]			[mm]	[mm]	[mm]	[mm]	[mm]
20	25	16	½	721 950 606	0.129	17.0	16.5	40	69.5	25
25	32	16	¾	721 950 607	0.232	19.0	19.0	50	83.2	30
32	40	16	1	721 950 608	0.352	22.0	22.5	59	95.5	36

20 91 07

Adaptor Sockets, Brass/PVC-U metric - R

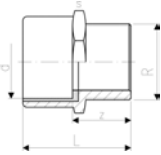

Model:

- Brass with taper male thread R and PVC-U solvent cement socket insert, metric
- Install with low mechanical stress and avoid large cyclic temperature changes

d [mm]	R [inch]	PN	Code	kg	z [mm]	L [mm]	s [mm]
20	1/2	16	720 910 706	0.159	27	45	36
25	3/4	16	720 910 707	0.202	28	49	40
32	1	16	720 910 708	0.303	33	57	48
40	1 1/4	16	720 910 709	0.437	36	64	58
50	1 1/2	16	720 910 710	0.671	38	72	70
63	2	16	720 910 711	1.035	43	84	85

20 91 02

Adaptor socket brass/PVC-U metric Rp

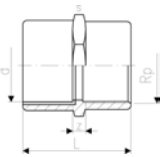

Model:

- Brass with parallel female thread Rp and PVC-U solvent cement socket insert, metric
- Install with low mechanical stress and avoid large cyclic temperature changes

d [mm]	Rp [inch]	PN	Code	kg	z [mm]	L [mm]	s [mm]
20	1/2	16	720 910 206	0.168	14	46	36
25	3/4	16	720 910 207	0.218	14	50	40
32	1	16	720 910 208	0.332	16	58	48
40	1 1/4	16	720 910 209	0.482	17	66	58
50	1 1/2	16	720 910 210	0.737	19	74	70
63	2	16	720 910 211	1.130	19	86	83

21 91 62

Manometer adaptor sockets PVC-U metric G

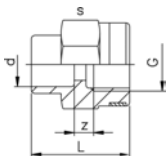

Model:

- With solvent cement socket metric and female thread G
- Reinforcing ring stainless (A2)
- Connection to plastic or metal threads
- Do not use thread sealing pastes that are harmful to PVC-U
- Install with low mechanical stress and avoid large cyclic temperature changes

d [mm]	G [inch]	PN	Code	kg	z [mm]	L [mm]	s [mm]
12	1/4	16	721 916 204	0.010	4	27	22
16	1/2	16	721 916 206	0.026	7	36	32

60 1002



Wall mounting bracket brass/PVC-U Metric/Rp

Model:

- Brass, with parallel female thread Rp and PVC-U solvent socket insert metric

as long as stocks last

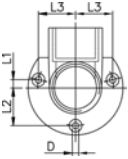
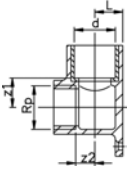

d [mm]	Rp [inch]	PN	Code	kg	z1 [mm]	z2 [mm]	D [mm]	L [mm]	L1 [mm]	L2 [mm]	L3 [mm]
# 16	3/8	16	160 100 250	0.252	21	9	5	14	6	19	18
20	1/2	16	160 100 300	0.278	22	9	5	16	6	19	18
25	3/4	16	160 100 350	0.258	25	11	5	17	5	24	23

21 96 03



Hose connector PVC-U metric

Model:

- With solvent cement spigot metric and tapered hose connection

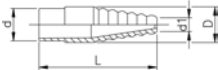

d [mm]	PN	Code	kg	d1 [mm]	D [mm]	L [mm]
10	16	721 960 303	0.004	6	12	51
12	16	721 960 304	0.004	6	12	51
16	16	721 960 305	0.007	8	16	57
20	16	721 960 306	0.016	11	22	73

21 96 04



Hose connector PVC-U metric

Model:

- With solvent cement spigot metric and parallel hose connection

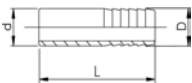

d [mm]	PN	Code	kg	D [mm]	L [mm]
10	16	721 960 403	0.002	8	47
12	16	721 960 404	0.003	12	51
16	16	721 960 405	0.008	16	57
20	16	721 960 406	0.016	20	73
25	16	721 960 407	0.021	25	79
32	16	721 960 408	0.035	30	89
40	16	721 960 409	0.060	40	100
50	16	721 960 410	0.112	50	105
63	16	721 960 411	0.180	60	120

Threaded fittings

21 10 16

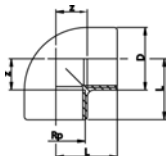

Elbow 90° PVC-U Rp

Model:

- With parallel female thread Rp
- Connection to plastic threads only
- Do not use thread sealing pastes that are harmful to PVC-U
- Install with low mechanical stress and avoid large cyclic temperature changes

as long as stocks last

Rp [inch]	PN	Code	kg	z [mm]	D [mm]	L [mm]
3/8	10	721 101 605	0.013	9	23	23
1/2	10	721 101 606	0.017	12	27	27
3/4	10	721 101 607	0.028	15	33	33
1	10	721 101 608	0.042	19	39	39
1 1/4	10	721 101 609	0.070	27	48	49
1 1/2	10	721 101 610	0.177	35	61	59
2	10	721 101 611	0.322	44	75	72

21 20 16

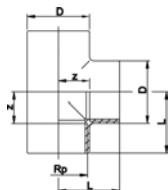

Tee 90° equal PVC-U Rp

Model:

- With parallel female thread Rp
- Connection to plastic threads only
- Do not use thread sealing pastes that are harmful to PVC-U
- Install with low mechanical stress and avoid large cyclic temperature changes

as long as stocks last

Rp [inch]	PN	Code	kg	z [mm]	D [mm]	L [mm]
3/8	10	721 201 605	0.016	9	23	23
1/2	10	721 201 606	0.027	12	28	27
3/4	10	721 201 607	0.039	15	33	33
1	10	721 201 608	0.072	19	41	39
1 1/4	10	721 201 609	0.117	27	50	49
1 1/2	10	721 201 610	0.267	36	62	60
2	10	721 201 611	0.485	44	77	72

21 91 06

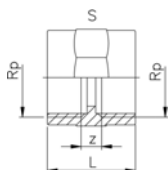

Socket PVC-U Rp

Model:

- With parallel female thread Rp
- Connection to plastic threads only
- Do not use thread sealing pastes that are harmful to PVC-U
- Install with low mechanical stress and avoid large cyclic temperature changes

Rp [inch]	PN	Code	kg	z [mm]	L [mm]	s [mm]
1/4	10	721 910 604	0.010	7	27	22
3/8	10	721 910 605	0.015	7	29	27
1/2	10	721 910 606	0.024	9	35	32
3/4	10	721 910 607	0.029	9	39	36
1	10	721 910 608	0.053	11	45	46

table continued next page

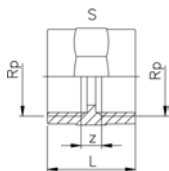

Rp [inch]	PN	Code	kg	z [mm]	L [mm]	s [mm]
1 ¼	10	721 910 609	0.076	11	49	55
1 ½	10	721 910 610	0.106	11	49	65
2	10	721 910 611	0.180	11	57	80

21 91 08

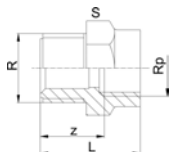

Reducing bush PVC-U R Rp

Model:

- With taper male thread R and parallel female thread Rp
- Connection to plastic threads only
- Do not use thread sealing pastes that are harmful to PVC-U
- Install with low mechanical stress and avoid large cyclic temperature changes

R [inch]	Rp [inch]	PN	Code	kg	z [mm]	L [mm]	s [mm]
½	¾	10	721 910 834	0.014	25	36	27
¾	½	10	721 910 837	0.021	25	39	32
1	½	10	721 910 842	0.028	31	45	32
1	¾	10	721 910 841	0.031	29	45	36
1 ¼	1	10	721 910 846	0.050	32	50	46
1 ½	1 ¼	10	721 910 852	0.065	35	55	55
2	1 ½	10	721 910 858	0.127	45	65	65

21 91 19

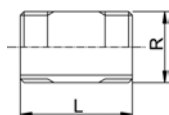
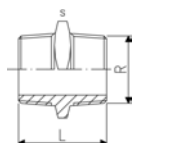

Threaded nipple R PVC-U

Model:

- With taper male thread R
- Do not use thread sealing pastes that are harmful to PVC-U
- Install with low mechanical stress and avoid large cyclic temperature changes

R [inch]	PN	Type	Code	kg	L [mm]	s [mm]
¾	10	A	721 911 905	0.007	37	19
½	10	A	721 911 906	0.012	45	22
¾	10	A	721 911 907	0.019	49	27
1	10	A	721 911 908	0.034	57	36
1 ¼	10	A	721 911 909	0.052	62	46
1 ½	10	A	721 911 910	0.070	67	50
2	10	A	721 911 911	0.126	76	65

21 91 19

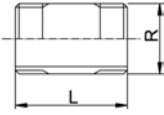

Threaded nipple R PVC-U

Model:

- With taper male thread R
- Do not use thread sealing pastes that are harmful to PVC-U
- Install with low mechanical stress and avoid large cyclic temperature changes

R [inch]	PN	Code	kg	L [mm]
3/8	10	721 911 505	0.010	43
1/2	10	721 911 506	0.012	50
3/4	10	721 911 507	0.018	56
1	10	721 911 508	0.032	63
1 1/4	10	721 911 509	0.055	75
1 1/2	10	721 911 510	0.077	88
2	10	721 911 511	0.120	88
3	10	721 911 513	0.232	102
4	10	721 911 515	0.560	122

21 96 06

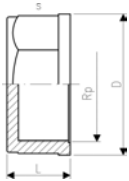

Cap PVC-U Rp

Model:

- With parallel female thread Rp
- Connection to plastic threads only
- Do not use thread sealing pastes that are harmful to PVC-U
- Install with low mechanical stress and avoid large cyclic temperature changes

Rp [inch]	PN	Code	kg	D [mm]	L [mm]	s [mm]
3/8	10	721 960 603	0.013	20	14	17
1/4	10	721 960 604	0.024	25	16	22
3/8	10	721 960 605	0.005	31	19	27
1/2	10	721 960 606	0.018	37	21	32
3/4	10	721 960 607	0.024	42	24	36
1	10	721 960 608	0.040	50	26	46
1 1/4	10	721 960 609	0.059	60	29	55
1 1/2	10	721 960 610	0.072	65	31	60
2	10	721 960 611	0.127	81	36	75

21 96 09

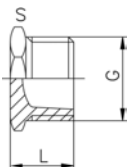

Plug PVC-U G

Model:

- With parallel male thread G
- Connection to plastic threads only
- Flat gasket necessary for sealing
- Do not use thread sealing pastes that are harmful to PVC-U
- Install with low mechanical stress and avoid large cyclic temperature changes

G [inch]	PN	Code	kg	L [mm]	s [mm]
3/8	10	721 960 905	0.005	21	22
1/2	10	721 960 906	0.001	25	27
3/4	10	721 960 907	0.019	29	36
1	10	721 960 908	0.029	32	41
1 1/4	10	721 960 909	0.048	36	50
1 1/2	10	721 960 910	0.070	37	60
2	10	721 960 911	0.120	42	75

21 96 19

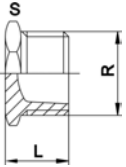

Plug PVC-U R

Model:

- With taper male thread R
- Do not use thread sealing pastes that are harmful to PVC-U
- Install with low mechanical stress and avoid large cyclic temperature changes

R [inch]	PN	Code	kg	L [mm]	s [mm]
3/8	10	721 961 905	0.006	21	22
1/2	10	721 961 906	0.011	25	27
3/4	10	721 961 907	0.020	29	36
1	10	721 961 908	0.030	32	41
1 1/4	10	721 961 909	0.048	36	50
1 1/2	10	721 961 910	0.072	37	60
2	10	721 961 911	0.121	42	75

21 96 07

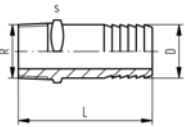

Hose connector PVC-U R

Model:

- With taper male thread R
- With parallel hose connector
- Do not use thread sealing pastes that are harmful to PVC-U

R [inch]	PN	Code	kg	D [mm]	L [mm]	s [mm]
1/4	10	721 960 704	0.003	12	59	14
3/8	10	721 960 705	0.006	16	67	19
1/2	10	721 960 706	0.020	20	86	22
3/4	10	721 960 707	0.027	25	92	27
1	10	721 960 708	0.048	30	103	36
1 1/4	10	721 960 709	0.079	40	115	46

Flange adaptors

21 79 01 / 21 80 01

Flange adaptor PVC-U Combined jointing face flat and serrated metric

Model:

- Solvent cement socket metric
- d63 - d400: Combined Jointing face flat and serrated
- Gasket: Profile flange gasket EPDM No. 48 44 07, FPM No. 49 44 07 or Flat gasket EPDM No. 48 40 03
Only use O-ring EPDM No. 48 41 01, FPM No. 49 41 01 in combination with counterpart Flange Adaptor No. 21 81 01
- Flange: PVC-U No. 21 70 00, PP with steel ring No. 27 70 02, Backing Flange PP-V for socket systems metric No. 27 70 04

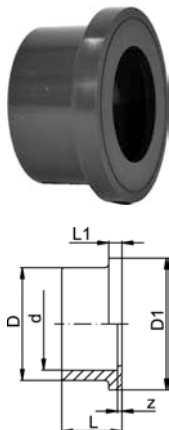

Note: The flat gasket affects the maximum allowable operating pressure!

d [mm]	d [inch]	DN [mm]	PN	Code	kg	z [mm]	D [mm]	D1 [mm]	L [mm]	L1 [mm]
16		10	16	721 800 105	0.006	3	22	29	17	6
20		15	16	721 800 106	0.009	3	27	34	19	6
25		20	16	721 800 107	0.015	3	33	41	22	7
32		25	16	721 800 108	0.024	3	41	50	25	7
40		32	16	721 800 109	0.038	3	50	61	29	8
50		40	16	721 800 110	0.056	3	61	73	34	8
63		50	16	721 790 111	0.102	3	77	90	41	9
75	2 ½	65	16	721 790 112	0.159	3	91	106	47	10
90		80	16	721 790 113	0.253	5	108	125	56	11
110		100	16	721 790 114	0.417	5	131	150	66	12
125		100	16	721 790 115	0.533	5	148	170	74	13
140	5	125	16	721 790 116	0.725	5	165	188	81	14
160		150	16	721 790 117	1.093	5	188	213	91	16
200		200	10	721 790 119	1.443	6	224	250	112	24
225		200	10	721 790 120	1.743	6	248	274	125	25
250		250	10	721 790 121	2.203	9	274	303	140	23
280		250	10	721 790 122	2.967	5	308	329	151	23
315		300	6	721 790 123	4.507	8	346	379	172	27
355		350	6	721 790 124	5.881	10	384	430	194	32
400		400	6	721 790 125	9.041	10	438	482	216	34

21 81 01

Flange adaptor PVC-U

Joining face with O-ring groove metric

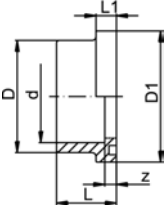

Model:

- Solvent cement socket metric
- Counterpart: Flange Adaptor flat No. 21 80 01
Combined Flange Adaptor (d160, d200, d225, d280, d315)
- Gasket: O-ring EPDM No. 48 41 01, FPM No. 49 41 01
- Flange: PVC-U No. 21 70 00, PP/Steel Nr. 27 70 02, PP-V for socket systems metric No. 27 70 04

d [mm]	DN [mm]	d [inch]	PN	Code	kg	z [mm]	D [mm]	D1 [mm]	L [mm]	L1 [mm]
16	10		16	721 810 105	0.008	6	22	29	20	9
20	15		16	721 810 106	0.011	6	27	34	22	9
25	20		16	721 810 107	0.018	6	33	41	25	10
32	25		16	721 810 108	0.027	6	41	50	28	10
40	32		16	721 810 109	0.046	8	50	61	34	13
50	40		16	721 810 110	0.066	8	61	73	39	13
63	50		16	721 810 111	0.118	8	77	90	46	14
75	65	2 ½	16	721 810 112	0.183	8	91	106	52	15
90	80		16	721 810 113	0.286	10	108	125	61	16
110	100		16	721 810 114	0.478	11	131	150	72	18
125	100		16	721 810 115	0.607	11	148	170	80	19
140	125	5	16	721 810 116	0.804	11	165	188	87	20
160	150		16	721 810 117	1.226	11	188	213	97	22
200	200		10	721 810 119	1.593	12	224	250	118	30
225	200		10	721 810 120	1.878	12	248	274	131	31
250	250		10	721 810 121	2.175	9	274	303	140	23
280	250		10	721 810 122	3.170	13	308	329	158	30
315	300		6	721 810 123	4.891	17	346	379	180	35

21 74 01

Fixed flange PVC-U

Combined joining face: flat and serrated metric

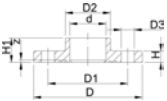

Model:

- Solvent cement socket metric
- Connecting dimension: ISO 7005 PN 10, EN 1092 PN 10, DIN 2501 PN 10, BS 4504 PN 10
- **Bolt circle PN 10**

* Combined Flange, connecting dimensions EN1092 PN 10 and ANSI B 16.5 Class 150

d75 - d110: bolt hole as long hole version

AL: number of holes

d [mm]	DN [mm]	d [inch]	PN	Code	kg
20	15		16	721 740 106	0.100
25	20		16	721 740 107	0.130
32	25		16	721 740 108	0.185

table continued next page

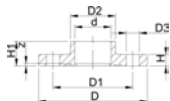

d [mm]	DN [mm]	d [inch]	PN	Code	kg
40	32		16	721 740 109	0.306
50	40		16	721 740 110	0.368
63	50		16	721 740 111	0.513
* 75	65	2 1/2	10	721 740 112	0.536
* 90	80	3	10	721 740 113	0.710
* 110	100	4	10	721 740 114	0.941
* 140	125	5	10	721 740 116	1.395
* 160	150	6	10	721 740 117	2.029

d [mm]	D [mm]	D1 [mm]	D1 max. [mm]	D1 min. [mm]	D2 [mm]	D3 [mm]	H [mm]	H1 [mm]	z [mm]	AL	SC
20	95	65			27	14	12	19	3	4	M12
25	105	75			33	14	13	22	3	4	M12
32	115	85			41	14	14	25	3	4	M12
40	140	100			51	18	17	29	3	4	M16
50	150	110			62	18	17	34	3	4	M16
63	165	125			77	18	20	41	3	4	M16
* 75	185		139.5	144.0	91	19	21	47	3	4	M16
* 90	200		152.5	159.0	108	19	22	56	5	8	M16
* 110	220		181.0	190.5	131	24	24	66	5	8	M20
* 140	250	215			165	23	28	91	5	8	M20
* 160	285	240			188	23	30	91	5	8	M20

Unions for solvent cement jointing

21 51 01

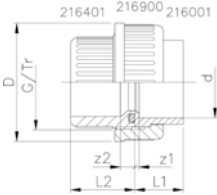

Union for solvent cement jointing PVC-U metric

Model:

- Union End: solvent socket metric
- Union Bush: Solvent socket metric
- Jointing face: With O-ring groove
- Gasket: O-Ring EPDM No. 48 41 00, FPM No. 49 41 00

d [mm]	d [inch]	PN	EPDM Code	FPM Code	kg
10		16	721 510 103	721 510 128	0.020
12		16	721 510 104	721 510 129	0.019
16		16	721 510 105	721 510 130	0.025
20		16	721 510 106	721 510 131	0.042
25		16	721 510 107	721 510 132	0.058
32		16	721 510 108	721 510 133	0.084
40		16	721 510 109	721 510 134	0.152
50		16	721 510 110	721 510 135	0.207
63		16	721 510 111	721 510 136	0.361
75	2 ½	10	721 510 112	721 510 137	0.621
90		10	721 510 313	721 510 338	0.929
110		10	721 510 114	721 510 139	1.492

d [mm]	z1 [mm]	z2 [mm]	D [mm]	L1 [mm]	L2 [mm]	G/Tr
10	3	10	31	15	22	5/8
12	3	10	31	15	22	5/8
16	3	10	35	17	24	3/4
20	3	10	43	19	26	1
25	3	10	51	22	29	1 1/4
32	3	10	58	25	33	1 1/2
40	3	12	72	29	39	2
50	3	14	83	34	46	2 1/4
63	3	18	100	41	58	2 3/4
75	3	18	135	47	62	Tr108x5
90	5	18	158	56	69	Tr128x5
110	5	11	188	66	72	Tr154x6

21 51 03

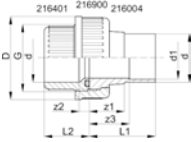

PRO-FIT Unions for solvent cement jointing, PVC-U metric

Model:

- Union End: Solvent cemented spigot in combination with reducing socket metric
- Union Bush: Solvent socket metric
- Gasket: O-Ring EPDM No. 48 41 00, FPM No. 49 41 00

d [mm]	d1 [mm]	PN	EPDM Code	FPM Code	kg
* 16	12	16	721 510 305	721 510 330	0.029
* 20	16	16	721 510 306	721 510 331	0.044
* 25	20	16	721 510 307	721 510 332	0.073
* 32	25	16	721 510 308	721 510 333	0.095
40	32	16	721 510 309	721 510 334	0.171
50	40	16	721 510 310	721 510 335	0.250
63	50	16	721 510 311	721 510 336	0.449

d [mm]	z1 [mm]	z2 [mm]	z3 [mm]	D [mm]	L1 [mm]	L2 [mm]	G [inch]
* 16	22	10	24	35	36	24	¾
* 20	24	10	26	43	40	26	1
* 25	25	10	28	51	44	29	1 ¼
* 32	27	10	30	58	49	33	1 ½
40	31	12	35	74	57	39	2
50	35	14	40	83	66	46	2 ¼
63	39	18	46	100	77	58	2 ¾

21 51 00

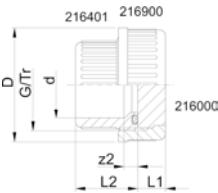

Union with union end blank PVC-U metric

d [mm]	PN	EPDM Code	FPM Code	kg	z2 [mm]	D [mm]	L1 [mm]	L2 [mm]	G/Tr
10	16	721 510 003	721 510 028	0.020	9	31	10	22	5/8
12	16	721 510 004	721 510 029	0.020	9	31	15	22	5/8
16	16	721 510 005	721 510 030	0.026	10	35	10	24	3/4
20	16	721 510 006	721 510 031	0.041	10	43	11	26	1
25	16	721 510 007	721 510 032	0.068	10	51	11	29	1 1/4
32	16	721 510 008	721 510 033	0.095	10	58	12	33	1 1/2
40	16	721 510 009	721 510 034	0.159	12	72	13	39	2
50	16	721 510 010	721 510 035	0.227	14	83	16	46	2 1/4
63	16	721 510 011	721 510 036	0.405	18	100	18	58	2 3/4
75	10	721 510 012	721 510 037	0.693	18	135	22	62	Tr108x5
90	10	721 510 213	721 510 238	1.022	18	158	24	69	Tr128x5
110	10	721 510 014	721 510 039	1.573	11	188	26	72	Tr154x6

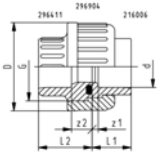

Thread union PVC-U Rp Rp

Model:

- Union End: Parallel female thread Rp
- Union Bush: Parallel female thread Rp
- Union nut: PVC-U
- Gasket: O-Ring EPDM No. 48 41 00
- Can be supplied with FPM O-Ring No. 49 41 00
- Connection to plastic threads only
- Do not use thread sealing pastes that are harmful to PVC-U

Rp [inch]	PN	Code	kg	z1 [mm]	z2 [mm]	D [mm]	L1 [mm]	L2 [mm]	G [inch]	
1/4	10	721 510 604	0.019	3	12	31	22	15	5/8	
3/8	10	721 510 605	0.027	3	13	35	24	17	3/4	
1/2	10	721 510 606	0.042	3	13	43	26	19	1	
3/4	10	721 510 607	0.065	3	14	51	29	22	1 1/4	
1	10	721 510 608	0.093	3	15	58	32	25	1 1/2	
1 1/4	10	721 510 609	0.160	3	19	72	38	29	2	
1 1/2	10	721 510 610	0.220	3	26	83	45	34	2 1/4	
2	10	721 510 611	0.415	3	33	100	56	41	2 3/4	

Adaptor unions

21 51 31

Unions for solvent cement jointing, PVC-U metric - BS

Model:

- Union End: Solvent cement socket metric
- Union Bush: Solvent cement socket BS inch
- Gasket: O-ring EPDM No. 48 41 00
- Can be supplied with FPM O-Ring No. 49 41 00

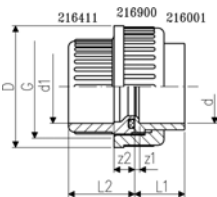

d [mm]	d1 [inch]	PN	Code	kg	z1 [mm]	z2 [mm]	D [mm]	L1 [mm]	L2 [mm]	G [inch]
16	3/8	15	721 513 105	0.025	3	8	35	17	24	3/4
20	1/2	15	721 513 106	0.040	3	9	43	19	26	1
25	3/4	15	721 513 107	0.065	3	9	51	22	29	1 1/4
32	1	15	721 513 108	0.090	3	9	58	25	33	1 1/2
40	1 1/4	15	721 513 109	0.155	3	10	72	29	39	2
50	1 1/2	15	721 513 110	0.200	3	10	83	34	46	2 1/4
63	2	15	721 513 111	0.341	3	10	100	41	58	2 3/4

21 51 41

Unions for solvent cement jointing, PVC-U metric - ASTM

Model:

- Union End: Solvent cement socket ASTM
- Union Bush: Solvent socket metric
- Gasket: O-ring EPDM No. 48 41 00
- Can be supplied with FPM O-Ring No. 49 41 00

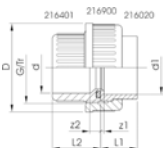

d [mm]	d1 [inch]	PN	Code	kg	z1 [mm]	z2 [mm]	D [mm]	L1 [mm]	L2 [mm]	G [inch]
16	3/8	16	721 514 105	0.022	3	10	35	22	24	3/4
20	1/2	16	721 514 106	0.042	3	10	43	25	26	1
25	3/4	16	721 514 107	0.065	3	10	51	28	29	1 1/4
32	1	16	721 514 108	0.103	3	10	58	32	33	1 1/2
40	1 1/4	16	721 514 109	0.174	3	12	72	35	39	2
50	1 1/2	16	721 514 110	0.239	3	14	83	38	46	2 1/4
63	2	16	721 514 111	0.356	3	18	100	41	58	2 3/4

21 51 02

Adaptor union PVC-U metric Rp

Model:

- Union End: Solvent cement socket metric
- Union Bush: Parallel female thread Rp
- Gasket: O-Ring No. 48 41 00
- Can be supplied with FPM O-Ring No. 49 41 00
- Connection to plastic threads only
- Do not use thread sealing pastes that are harmful to PVC-U

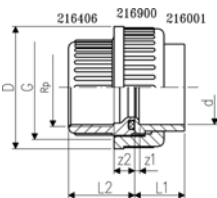

d [mm]	Rp [inch]	PN	Code	kg	z1 [mm]	z2 [mm]	D [mm]	L1 [mm]	L2 [mm]	G [inch]
12	1/4	10	721 510 204	0.019	3	12	31	15	22	5/8
16	3/8	10	721 510 205	0.020	3	13	35	17	24	3/4
20	1/2	10	721 510 206	0.040	3	13	43	19	26	1
25	3/4	10	721 510 207	0.057	3	14	51	22	29	1 1/4
32	1	10	721 510 208	0.084	3	15	58	25	33	1 1/2

table continued next page

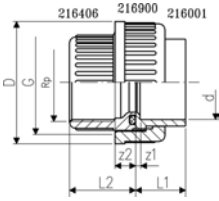

d	Rp	PN	Code	kg	z1	z2	D	L1	L2	G	
[mm]	[inch]				[mm]	[mm]	[mm]	[mm]	[mm]	[inch]	
40	1 ¼	10	721 510 209	0.147	3	19	72	29	39	2	
50	1 ½	10	721 510 210	0.218	3	26	83	34	46	2 ¼	
63	2	10	721 510 211	0.383	3	33	100	41	58	2 ¾	

21 51 04

PRO-FIT adaptor union PVC-U metric Rp

Model:

- Union End: Solvent cemented spigot in combination with reducing socket metric
- Union Bush: Threaded socket with parallel female thread Rp
- Gasket: O-Ring EPDM No. 48 41 00, FPM No. 49 41 00
- Can be supplied with FPM O-Ring No. 49 41 00
- Connection to plastic threads only
- Do not use thread sealing pastes that are harmful to PVC-U



*

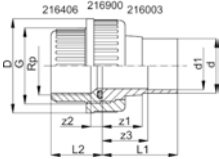

d	d1	Rp	PN	EPDM Code	kg	z1	z2	z3	D	L1	L2	G	
[mm]	[mm]	[inch]				[mm]	[mm]	[mm]	[mm]	[mm]	[mm]	[inch]	
* 16	12	¾	10	721 510 405	0.032	22	13	24	35	36	24	¾	
* 20	16	¾	10	721 510 406	0.046	24	13	26	43	40	26	1	
* 25	20	¾	10	721 510 407	0.079	25	14	28	51	44	29	1 ¼	
* 32	25	1	10	721 510 408	0.116	27	15	30	58	49	32	1 ½	
40	32	1 ¼	10	721 510 409	0.192	31	19	35	74	57	38	2	
50	40	1 ½	10	721 510 410	0.263	35	26	40	83	66	45	2 ¼	
63	50	2	10	721 510 411	0.496	39	33	46	100	77	56	2 ¾	

21 51 42

Adaptor union PVC-U metric NPT

Model:

- Union End: Taper female thread NPT (ASTM)
- Union Bush: Solvent socket metric
- Gasket: O-ring EPDM No. 48 41 00
- Can be supplied with FPM O-Ring No. 49 41 00
- Connection to plastic threads only
- Do not use thread sealing pastes that are harmful to PVC-U

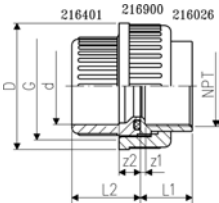

d	NPT	PN	Code	kg	z1	z2	D	L1	L2	G	
[mm]	[inch]				[mm]	[mm]	[mm]	[mm]	[mm]	[inch]	
16	¾	10	721 514 205	0.026	4	10	35	17	24	¾	
20	½	10	721 514 206	0.042	2	10	43	19	26	1	
25	¾	10	721 514 207	0.068	4	10	51	22	29	1 ¼	
32	1	10	721 514 208	0.093	4	10	58	25	33	1 ½	
40	1 ¼	10	721 514 209	0.150	6	12	72	29	39	2	
50	1 ½	10	721 514 210	0.228	11	14	83	34	46	2 ¼	
63	2	10	721 514 211	0.387	17	18	100	41	58	2 ¾	

21 54 02

Adaptor union PVC-U/stainless steel metric Rp

Model:

- Union End: Stainless Steel 1.4404 (316L), parallel female thread Rp
- Union Bush: Solvent cement socket PVC-U metric
- Union nut: PVC-U
- Gasket: O-Ring EPDM No. 48 41 00, FPM No. 49 41 00

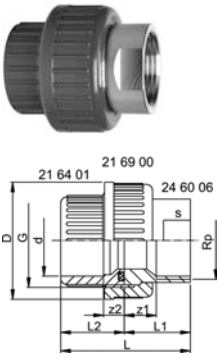

d [mm]	Rp [inch]	PN	EPDM Code	FPM Code	kg
16	3/8	16	721 540 205	721 540 230	0.053
20	1/2	16	721 540 206	721 540 231	0.096
25	3/4	16	721 540 207	721 540 232	0.134
32	1	16	721 540 208	721 540 233	0.212
40	1 1/4	16	721 540 209	721 540 234	0.343
50	1 1/2	16	721 540 210	721 540 235	0.455
63	2	16	721 540 211	721 540 236	0.721

d [mm]	z1 [mm]	z2 [mm]	D [mm]	L [mm]	L1 [mm]	L2 [mm]	G [inch]	s [mm]
16	9	10	35	43	19	24	3/4	19
20	11	10	43	50	24	26	1	24
25	11	10	51	55	26	29	1 1/4	29
32	12	10	58	61	29	33	1 1/2	36
40	14	12	72	71	33	39	2	45
50	15	14	83	79	34	46	2 1/4	54
63	15	18	100	95	39	58	2 3/4	63

21 54 07

Adaptor union PVC-U/stainless steel metric R

Model:

- Union End: Stainless Steel 1.4404 (316L), taper male thread R
- Union Bush: Solvent cement socket PVC-U metric
- Union nut: PVC-U
- Gasket: O-Ring EPDM No. 48 41 00, FPM No. 49 41 00

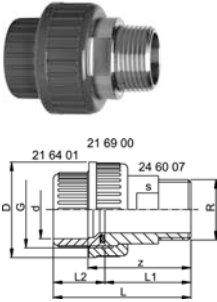

d [mm]	R [inch]	PN	EPDM Code	FPM Code	kg
16	3/8	16	721 540 705	721 540 730	0.073
20	1/2	16	721 540 706	721 540 731	0.126
25	3/4	16	721 540 707	721 540 732	0.170
32	1	16	721 540 708	721 540 733	0.262
40	1 1/4	16	721 540 709	721 540 734	0.472
50	1 1/2	16	721 540 710	721 540 735	0.535
63	2	16	721 540 711	721 540 736	0.931

d [mm]	z [mm]	D [mm]	L [mm]	L1 [mm]	L2 [mm]	G [inch]	s [mm]
16	40	35	54	30	24	3/4	19
20	44	43	60	34	26	1	24
25	46	51	65	36	29	1 1/4	32
32	50	58	72	40	33	1 1/2	37
40	58	72	84	46	39	2	48
50	62	83	93	48	46	2 1/4	54
63	73	100	111	55	58	2 3/4	69

21 54 55

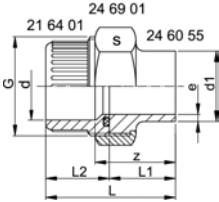

Adaptor union PVC-U/stainless steel metric Welding end

Model:

- Union End: Stainless Steel 1.4404 (316L) with welding end
- Union Bush: Solvent cement socket PVC-U metric
- Union Nut: Stainless Steel WN 1.4404 (316L)
- Gasket: O-Ring EPDM No. 48 41 00, FPM No. 49 41 00

d [mm]	d1 [mm]	PN	EPDM Code	FPM Code	kg
16	17	16	721 545 505	721 545 530	0.101
20	21	16	721 545 506	721 545 531	0.168
25	27	16	721 545 507	721 545 532	0.198
32	34	16	721 545 508	721 545 533	0.313
40	42	16	721 545 509	721 545 534	0.493
50	48	16	721 545 510	721 545 535	0.605
63	60	16	721 545 511	721 545 536	0.902

d [mm]	z [mm]	L [mm]	L1 [mm]	L2 [mm]	e [mm]	G [inch]	s [mm]
16	28	42	18	24	1.6	¾	32
20	32	48	22	26	2.0	1	41
25	33	52	23	29	2.0	1 ¼	46
32	36	58	26	33	2.0	1 ½	55
40	38	64	26	39	2.0	2	68
50	42	73	28	46	2.0	2 ¼	74
63	50	88	32	58	2.6	2 ¾	88

21 53 03

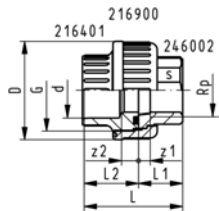

Adaptor union PVC-U/malleable iron galvanised metric Rp

Model:

- Union nut: PVC-U
- Union Bush: Solvent cement socket PVC-U metric
- Union End: malleable iron with parallel female thread Rp
- Gasket: O-Ring EPDM No. 48 41 00

d [mm]	Rp [inch]	Code	kg
20	½	721 530 306	0.073
25	¾	721 530 307	0.107
32	1	721 530 308	0.154
40	1 ¼	721 530 309	0.282
50	1 ½	721 530 310	0.377
63	2	721 530 311	0.594
75	2 ½	721 530 312	1.008
90	3	721 530 313	1.350

d [mm]	D [mm]	L [mm]	L1 [mm]	L2 [mm]	z1 [mm]	z2 [mm]	G [inch]	s [mm]
20	43	48	22	26	9	10		1
25	51	51	22	29	7	10		1 1/4
32	58	58	26	33	9	10		1 1/2
40	72	69	31	39	12	12		2
50	83	78	33	46	14	14		2 1/4
63	100	91	35	58	11	18		2 3/4
75	127	101	39	62	12	18		Tr 108x5
90	150	114	45	69	15	19		Tr 128x5

21 53 08

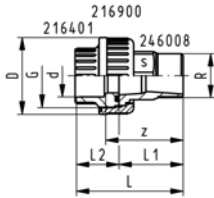

Adaptor union PVC-U/malleable iron galvanized metric R

Model:

- Union nut: PVC-U
- Union Bush: Solvent cement socket PVC-U metric
- Union End: Malleable iron with taper male thread R
- Gasket: O-Ring EPDM No. 48 41 00

d [mm]	R [inch]	Code	kg	D [mm]	L [mm]	L1 [mm]	L2 [mm]	z [mm]	G [inch]	s [mm]
20	1/2	721 530 806	0.107	43	66	40	26	50	1	25
25	3/4	721 530 807	0.159	51	72	43	29	53	1 1/4	31
32	1	721 530 808	0.213	58	80	48	33	58	1 1/2	38
40	1 1/4	721 530 809	0.426	72	95	57	39	69	2	48
50	1 1/2	721 530 810	0.528	83	104	59	46	73	2 1/4	54
63	2	721 530 811	0.863	100	118	62	58	80	2 3/4	67
75	2 1/2	721 530 812	1.441	127	137	75	62	93	Tr 108x5	85
90	3	721 530 813	1.873	150	149	80	69	99	Tr 128x5	96

21 55 05

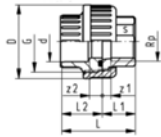

Adaptor union PVC-U/brass metric Rp

Model:

- Union nut: PVC-U
- Union bush: Solvent cement socket metric
- Union End: Brass with parallel female thread Rp
- Gasket: O-ring EPDM No. 48 41 00

d [mm]	Rp [inch]	PN* [bar]	Code	kg
20	1/2	16	721 550 506	0.088
25	3/4	16	721 550 507	0.145
32	1	16	721 550 508	0.175
40	1 1/4	16	721 550 509	0.322
50	1 1/2	16	721 550 510	0.467
63	2	16	721 550 511	0.776
75	2 1/2	16	721 550 512	1.360
90	3	16	721 550 513	2.003

d [mm]	Rp [inch]	D [mm]	L [mm]	L1 [mm]	L2 [mm]	z1 [mm]	z2 [mm]	G [inch]	s [mm]
20	1/2	43	48	22	26	7	10	1	25
25	3/4	51	54	25	29	9	10	1 1/4	30
32	1	58	60	27	33	8	11	1 1/2	36
40	1 1/4	72	70	31	39	10	13	2	46
50	1 1/2	83	81	35	46	13	15	2 1/4	55
63	2	100	98	40	58	14	20	2 3/4	65
75	2 1/2	127	109	47	62	16	18	Tr 108x5	85
90	3	150	121	52	69	18	18	Tr 128x5	95

21 55 09

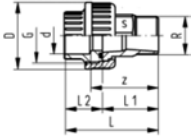

Adaptor union PVC-U/brass metric R

Model:

- Union nut: PVC-U
- Union Bush: Solvent cement socket PVC-U metric
- Union End: Brass with taper male thread R
- Gasket: O-Ring EPDM No. 48 41 00

d	R	PN*	Code	kg
[mm]	[inch]	[bar]		
20	½	16	721 550 906	0.125
25	½	16	721 550 957	0.196
25	¾	16	721 550 907	0.196
25	1	16	721 550 967	0.307
32	½	16	721 550 958	0.297
32	¾	16	721 550 968	0.297
32	1	16	721 550 908	0.283
40	1 ¼	16	721 550 909	0.502
50	1 ½	16	721 550 910	0.681
63	2	16	721 550 911	1.101
75	2 ½	16	721 550 912	1.706
90	3	16	721 550 913	2.662

d	R	D	L	L1	L2	z	G	s
[mm]	[inch]	[mm]	[mm]	[mm]	[mm]	[mm]	[inch]	[mm]
20	½	43	63	37	26	47		1
25	½	51	66	37	29	47		1 1/4
25	¾	51	71	42	29	52		1 1/4
25	1	51	75	46	29	56		1 1/4
32	½	58	70	37	33	48		1 1/2
32	¾	58	75	42	33	53		1 1/2
32	1	58	79	46	33	57		1 1/2
40	1 ¼	72	91	52	39	65		2
50	1 ½	83	102	56	46	71		2 1/4
63	2	100	125	67	58	87		2 3/4
75	2 ½	127	139	77	62	95	Tr 108x5	85
90	3	150	155	86	69	104	Tr 125x8	95

21 55 03

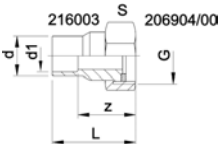

Tap connectors PVC-U/brass metric G

Model:

- Union End: PVC-U, solvent cement socket / spigot metric
- Union Nut: brass with female thread G
- Gasket: flat gasket EPDM No. 48 40 02

d	d1	G	PN	Code	kg	z	L	s
[mm]	[mm]	[inch]				[mm]	[mm]	[mm]
16	12	½	16	721 550 305	0.031	22	34	24
20	16	¾	16	721 550 306	0.049	24	38	30
25	20	1	16	721 550 307	0.079	27	43	38

Union Ends

21 60 01

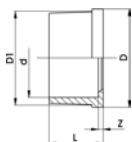

Union end PVC-U metric

Model:

- Solvent cement socket metric
- Suitable for unions, tank connectors and diaphragm valves Type 514

* for Adaptor Unions 21 53 02, 21 53 07, 21 55 02, 21 55 07 old version

d [mm]	PN	Code	kg	z [mm]	D [mm]	D1 [mm]	L [mm]
10	16	721 500 103	0.004	3	20	18	15
12	16	721 500 104	0.004	3	20	18	15
16	16	721 500 105	0.005	3	24	22	17
20	16	721 500 106	0.009	3	30	28	19
25	16	721 500 107	0.015	3	39	36	22
32	16	721 500 108	0.020	3	45	42	25
40	16	721 500 109	0.037	3	57	53	29
50	16	721 500 110	0.039	3	63	59	34
63	16	721 500 111	0.072	3	78	74	41
75	10	721 500 162	0.140	3	101	90	47
90	10	721 500 163	0.242	5	121	108	56
110	10	721 500 164	0.390	5	146	131	66
* 75	10	721 600 112	0.155	3	97	90	47
* 90	10	721 600 113	0.188	5	110	105	56

21 60 11

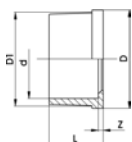

Union end PVC-U Inch BS

Model:

- Solvent cement socket BS inch

d [inch]	PN	Code	kg	z [mm]	D [mm]	D1 [mm]	L [mm]
3/8	15	721 601 105	0.001	3	24	22	19
1/2	15	721 601 106	0.008	3	30	27	21
3/4	15	721 601 107	0.013	3	38	36	24
1	15	721 601 108	0.018	3	44	41	27
1 1/4	15	721 601 109	0.033	3	56	53	32
1 1/2	15	721 601 110	0.051	3	62	59	33
2	15	721 601 111	0.077	3	78	74	40
3	9	721 601 113	0.196	6	110	105	56

21 60 20

Union end PVC-U ASTM

Model:

- With solvent cement socket ASTM

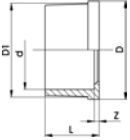

d [inch]	PN	Code	kg	z [mm]	D [mm]	D1 [mm]	L [mm]
3/8	16	721 602 005	0.005	3	24	22	22
1/2	16	721 602 006	0.029	3	30	28	25
3/4	16	721 602 007	0.015	3	39	36	28
1	16	721 602 008	0.023	3	45	42	32
1 1/4	16	721 602 009	0.034	3	57	53	35
1 1/2	16	721 602 010	0.047	3	63	59	38
2	16	721 602 011	0.075	3	78	74	41
2 1/2	10	721 602 012	0.164	3	101	90	47
3	10	721 602 013	0.255	5	121	108	56
3 1/2	10	721 602 014	0.334	5	146	131	66

21 60 04

Union end with spigot PVC-U metric

Model:

- Solvent cement spigot in combination with reducing socket metric
- Suitable for unions, tank connectors and diaphragm valves Type 514

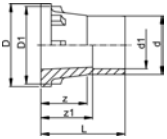

d [mm]	d1 [mm]	PN	Code	kg	z [mm]	z1 [mm]	D [mm]	D1 [mm]	L [mm]
* 16	12	16	721 500 405	0.001	22	24	24	22	36
* 20	16	16	721 500 406	0.009	24	26	30	28	40
* 25	20	16	721 500 407	0.026	25	28	39	36	44
* 32	25	16	721 500 408	0.200	27	30	45	42	49
40	32	16	721 500 409	0.055	31	35	57	53	57
50	40	16	721 500 410	0.085	35	40	63	59	66
63	50	16	721 500 411	0.108	39	46	79	74	77

21 60 03

Union end PVC-U metric

Model:

- For tap connector No. 21 55 03

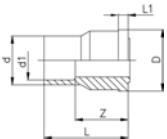

d [mm]	d1 [mm]	PN	Code	kg	z [mm]	D [mm]	L [mm]	L1 [mm]
16	12	16	721 600 305	0.005	22	19	34	3
20	16	16	721 600 306	0.009	24	24	38	5
25	20	16	721 600 307	0.016	27	30	43	5

21 60 06

Union end PVC-U Rp

Model:

- Parallel female thread Rp

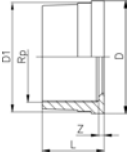

Rp [inch]	PN	Code	kg	z [mm]	D [mm]	D1 [mm]	L [mm]
1/4	10	721 600 654	0.004	5	20	18	15
3/8	10	721 600 655	0.005	6	24	22	17
1/2	10	721 600 656	0.010	6	30	28	19
3/4	10	721 600 657	0.012	7	39	36	22
1	10	721 600 658	0.019	8	45	42	25
1 1/4	10	721 600 659	0.038	10	57	53	29
1 1/2	10	721 600 660	0.057	11	63	59	34
2	10	721 600 661	0.102	18	78	74	41

21 60 26

Union end PVC-U NPT ASTM

Model:

- Taper female thread NPT (ASTM)

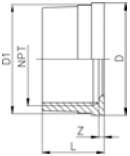

NPT [inch]	PN	Code	kg	z [mm]	D [mm]	D1 [mm]	L [mm]
3/8	10	721 602 655	0.005	4	24	22	17
1/2	10	721 602 656	0.009	2	30	28	19
3/4	10	721 602 657	0.015	4	39	36	22
1	10	721 602 658	0.025	3	45	42	25
1 1/4	10	721 602 659	0.040	6	57	53	29
1 1/2	10	721 602 660	0.055	11	63	59	34
2	10	721 602 661	0.128	17	78	74	41

21 60 00

Union end blank PVC-U

Model:

- For unions, tank adaptor and daphragm valve type 514
- Flat sealing faces



d [mm]	DN [mm]	Inch	PN	Code	kg	D [mm]	D1 [mm]	L [mm]	L1 [mm]
10/12		1/8	16	721 600 004	0.006	20	18	9	4
16	10	3/8	16	721 600 005	0.004	24	22	10	5
20	15	1/2	16	721 600 006	0.009	30	28	11	5
25	20	3/4	16	721 600 007	0.017	39	36	11	6
32	25	1	16	721 600 008	0.025	45	42	12	6
40	32	1 1/4	16	721 600 009	0.042	57	53	13	7
50	40	1 1/2	16	721 600 010	0.061	63	59	16	7
63	50	2	16	721 600 011	0.108	78	74	18	8
75	65	2 1/2	10	721 600 012	0.216	101	90	22	10
90	80	3	10	721 600 013	0.333	121	108	24	11
110	100	4	10	721 600 014	0.530	146	131	26	12

34 60 01

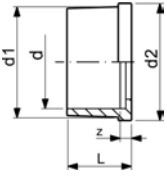

Union end PE80

Model:

- With fusion socket metric
- Suitable for unions, tank connectors and diaphragm valves Type 514

d [mm]	PN	Code	kg	d1 [mm]	d2 [mm]	L [mm]	L1 [mm]	z [mm]
20	10	734 600 106	0.006	28	30	19	5	5
25	10	734 600 107	0.013	36	39	21	5	5
32	10	734 600 108	0.015	42	45	23	6	5
40	10	734 600 109	0.026	53	57	25	6	5
50	10	734 600 110	0.025	59	63	28	7	5
63	10	734 600 111	0.044	74	79	32	8	5

Union end long PE100

Model:

- For butt-, IR Plus® and electrofusion
- Suitable for unions, tank connectors and diaphragm valves Type 514

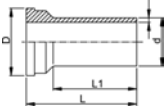

d [mm]	PN	FM	Code	kg	D [mm]	L [mm]	L1 [mm]	e [mm]
20	16	IR	753 508 616	0.006	30	67	52	1,9
25	16	IR	753 508 617	0.019	39	71	53	2,3
32	16	IR	753 508 618	0.006	45	73	55	2,9
40	16	IR	753 508 619	0.006	57	81	60	3,7
50	16	IR	753 508 620	0.006	63	87	66	4,6
63	16	IR	753 508 621	0.119	78	93	70	5,8

24 60 06

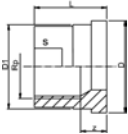

Union end stainless steel Rp

Model:

- Material: Stainless Steel 1.4404 (316L)
- Parallel female thread Rp

Rp [inch]	PN	Code	kg	z [mm]	D [mm]	D1 [mm]	L [mm]	s [mm]
3/8	16	724 600 655	0.030	9	24	22	19	19
1/2	16	724 600 656	0.060	11	30	28	24	24
3/4	16	724 600 657	0.092	11	39	36	26	29
1	16	724 600 658	0.137	12	45	42	29	36
1 1/4	16	724 600 659	0.226	14	57	53	33	45
1 1/2	16	724 600 660	0.314	15	63	59	34	54
2	16	724 600 661	0.450	15	78	74	39	63

24 60 07

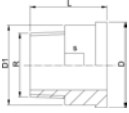

Union end stainless steel R

Model:

- Material: Stainless Steel 1.4404 (316L)
- Taper male thread R

R [inch]	PN	Code	kg	D [mm]	D1 [mm]	L [mm]	s [mm]	
3/8	16	724 600 705	0.052	24	22	30	19	
1/2	16	724 600 706	0.083	30	28	34	24	
3/4	16	724 600 707	0.125	39	36	36	32	
1	16	724 600 708	0.189	45	42	40	37	
1 1/4	16	724 600 709	0.356	57	53	46	48	
1 1/2	16	724 600 710	0.407	63	59	48	54	
2	16	724 600 711	0.668	78	74	55	69	

24 60 55

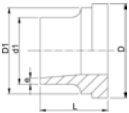

Union end stainless steel Welding end

Model:

- Material: Stainless Steel 1.4404 (316L)

d [mm]	d1 [mm]	PN	Code	kg	D [mm]	D1 [mm]	L [mm]	e [mm]	
16	17	16	724 605 505	0.029	24	22	18	1.6	
20	21	16	724 605 506	0.046	30	28	22	2.0	
25	26	16	724 605 507	0.080	39	36	23	2.0	
32	33	16	724 605 508	0.112	45	42	26	2.0	
40	42	16	724 605 509	0.188	57	53	26	2.0	
50	48	16	724 605 510	0.222	63	59	28	2.0	
63	60	16	724 605 511	0.361	78	74	32	2.6	

20 60 02

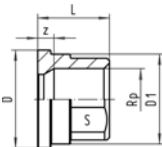

Union end brass Rp

Model:

- Union End: Brass with parallel female thread Rp

d [mm]	Rp [inch]	Code	kg	D [mm]	D1 [mm]	z [mm]	L [mm]	s [mm]	
20	1/2	720 600 236	0.059	30	28	5	22	25	
25	3/4	720 600 237	0.100	39	36	6	25	30	
32	1	720 600 238	0.128	45	42	6	27	36	
40	1 1/4	720 600 239	0.211	56	53	7	31	46	
50	1 1/2	720 600 240	0.324	62	59	7	35	55	
63	2	720 600 241	0.510	78	74	8	40	65	
75	2 1/2	720 600 242	0.893	100	92	10	47	85	
90	3	720 600 243	1.395	121	110	11	52	95	

20 60 02

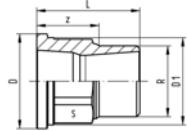
**Union end brass R****Model:**

- Union End: Brass with taper male thread R

d	R	Code	kg	D	D1	L	z	s	
[mm]	[inch]			[mm]	[mm]	[mm]	[mm]	[mm]	
20	1/2	720 600 246	0.092	30	28	37	22	25	
25	3/4	720 600 247	0.151	39	36	42	25	30	
25	1/2	720 600 257	0.142	39	36	42	27	30	
32	1	720 600 248	0.216	45	42	46	28	36	
32	1/2	720 600 258	0.113	45	42	46	31	36	
32	3/4	720 600 268	0.206	45	42	46	30	36	
40	1 1/4	720 600 249	0.408	56	53	52	32	46	
50	1 1/2	720 600 250	0.538	62	59	56	36	55	
63	2	720 600 251	0.859	78	74	67	42	65	
75	2 1/2	720 600 252	1.446	100	92	77	49	85	
90	3	720 600 253	2.063	121	110	86	54	95	

24 60 02

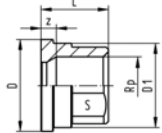
**Union end malleable iron galvanized Rp****Model:**

- Union End: malleable iron with parallel female thread Rp

d	Rp	PN	Code	kg	D	D1	L	z	s	
[mm]	[inch]				[mm]	[mm]	[mm]	[mm]	[mm]	
20	1/2	16	724 600 206	0.037	30	27	22	9	25	
25	3/4	16	724 600 207	0.072	39	36	22	7	31	
32	1	16	724 600 208	0.088	44	41	26	9	38	
32	1 1/4	16	724 600 209	0.172	56	52	31	12	48	
50	1 1/2	16	724 600 210	0.210	62	58	33	14	54	
63	2	16	724 600 211	0.331	78	73	35	11	67	
75	2 1/2	16	724 600 212	0.557	100	92	39	12	85	
90	3	16	724 600 213	0.650	121	110	45	15	96	

24 60 08

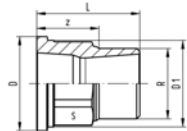
**Union end malleable iron galvanized R****Model:**

- Union End: Malleable iron with taper male thread R

d	R	Code	kg	D	D1	L	z	s	
[mm]	[inch]			[mm]	[mm]	[mm]	[mm]	[mm]	
20	1/2	724 600 806	0.069	30	27	40	25	23	
25	3/4	724 600 807	0.115	39	36	43	27	30	
32	1	724 600 808	0.161	44	41	48	29	36	
40	1 1/4	724 600 809	0.294	56	52	57	36	48	
50	1 1/2	724 600 810	0.353	62	58	59	37	54	
63	2	724 600 811	0.570	78	73	62	36	66	
75	2 1/2	724 600 812	0.980	100	92	75	45	85	
90	3	724 600 813	1.217	121	110	80	47	95	

Union bushes

21 64 01

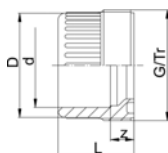

Union bush PVC-U metric

d [mm]	PN	Code	kg	z [mm]	D [mm]	L [mm]	G/Tr
10	16	721 840 103	0.002	10	20	22	5/8
12	16	721 840 104	0.014	10	20	22	5/8
16	16	721 840 105	0.009	10	24	24	3/4
20	16	721 840 106	0.014	10	29	26	1
25	16	721 840 107	0.022	10	34	29	1 1/4
32	16	721 840 108	0.035	10	42	33	1 1/2
40	16	721 840 109	0.063	12	52	39	2
50	16	721 840 110	0.073	14	62	46	2 1/4
63	16	721 840 111	0.132	18	78	58	2 3/4
75	10	721 840 112	0.210	18	93	62	Tr108x5
90	10	721 840 123	0.355	18	110	69	Tr128x5
110	10	721 840 114	0.445	11	133	72	Tr154x6

21 64 11

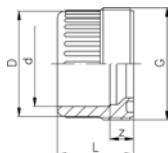

Union bush PVC-U Inch BS

Model:

- Solvent cement socket BS inch
- Jointing face: With O-Ring groove
- Gasket: O-Ring EPDM No. 48 41 00, FPM No. 49 41 00

d [inch]	PN	Code	kg	z [mm]	D [mm]	L [mm]	G [inch]
3/8	15	721 841 105	0.588	8	24	24	3/4"
1/2	15	721 841 106	0.012	9	29	26	1"
3/4	15	721 841 107	0.021	9	34	29	1 1/4"
1	15	721 841 108	0.031	9	42	33	1 1/2"
1 1/4	15	721 841 109	0.056	10	52	39	2"
1 1/2	15	721 841 110	0.075	10	62	46	2 1/4"
2	15	721 841 111	0.139	10	78	58	2 3/4"

21 64 06

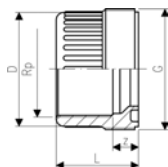

Union bush PVC-U Rp

Model:

- With parallel female thread Rp
- Jointing face: With O-Ring groove
- Gasket: O-Ring EPDM No. 48 41 00, FPM No. 49 41 00
- Connection to plastic threads only
- Do not use thread sealing pastes that are harmful to PVC-U

Rp [inch]	PN	Code	kg	z [mm]	D [mm]	L [mm]	G [inch]
1/4	10	721 840 604	0.069	12	20	22	5/8
3/8	10	721 840 605	0.900	13	24	24	3/4
1/2	10	721 840 606	0.013	13	29	26	1
3/4	10	721 840 607	0.021	14	34	29	1 1/4
1	10	721 840 608	0.036	15	42	32	1 1/2
1 1/4	10	721 840 609	0.063	19	53	38	2
1 1/2	10	721 840 610	0.098	26	63	45	2 1/4
2	10	721 840 611	0.187	33	78	56	2 3/4

Union nuts

21 69 00

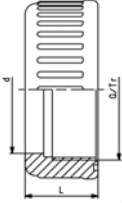

Union nut PVC-U

* for Adaptor unions PVC-U / malleable iron only

d [mm]	PN	Code	kg	L [mm]	G [inch]	Tr	d [mm]
10 - 12	16	721 890 004	0.009	19	$\frac{5}{8}$		19
16	16	721 890 005	0.012	21	$\frac{3}{4}$		22
20	16	721 890 006	0.026	23	1		28
25	16	721 890 007	0.020	24	1 $\frac{1}{4}$		36
32	16	721 890 008	0.029	26	1 $\frac{1}{2}$		41
40	16	721 890 009	0.049	29	2		53
50	16	721 890 010	0.089	34	2 $\frac{1}{4}$		59
63	16	721 890 011	0.129	38	2 $\frac{3}{4}$		74
75	10	721 890 012	0.256	40		Tr 108x5	92
90	10	721 890 013	0.370	43		Tr 128x5	110
* 90	10	721 890 023	0.355	43		Tr 128x5	105
110	10	721 890 014	0.574	48		Tr 154x6	133

24 69 01



Union nut stainless steel 1.4404 (316L)

* Octagon union nut

d [mm]	PN	Code	kg	L [mm]	G [inch]	s [mm]
16	16	724 690 105	0.060	19	$\frac{3}{4}$	32
20	16	724 690 106	0.105	21	1	41
25	16	724 690 107	0.091	23	1 $\frac{1}{4}$	46
32	16	724 690 108	0.170	24	1 $\frac{1}{2}$	55
* 40	16	724 690 109	0.218	27	2	68
* 50	16	724 690 110	0.316	31	2 $\frac{1}{4}$	74
* 63	16	724 690 111	0.364	35	2 $\frac{3}{4}$	88

20 69 00

20 69 04



Union nut, brass

• d12 - d20 for tap connector No. 21 55 03

d [mm]	G [inch]	PN	Code	kg	L [mm]	s [mm]
16	$\frac{1}{2}$	16	720 690 405	0.024	16	24
16	$\frac{3}{4}$	16	720 690 005	0.040	17	30
20	1	16	720 690 006	0.065	19	38
25	1 $\frac{1}{4}$	16	720 690 007	0.105	20	47
32	1 $\frac{1}{2}$	16	720 690 008	0.102	22	52
40	2	16	720 690 009	0.199	25	66
50	2 $\frac{1}{4}$	16	720 690 010	0.268	25	72
63	2 $\frac{3}{4}$	16	720 690 011	0.280	27	87
75	3 $\frac{1}{2}$	16	720 690 012	0.675	34	110

Seals

EPDM 48 41 00
FPM 49 41 00

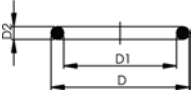

O-Ring gasket

Model:

- For unions and adaptor unions
- Hardness approx. 65° Shore
- EPDM minimum temperature -40°C
- FPM minimum temperature -15°C

* for unions PVC-U, PVC-C and ABS: 21 51 01, 21 51 11, 21 53 03, 21 53 08, 21 55 04, 21 55 13, 21 55 18, 23 51 01 and 29 51 01 only

d [mm]	DN [mm]	EPDM Code	FPM Code	kg	D [mm]	D1 [mm]	D2 [mm]
10 - 12	8	748 410 004	749 410 004	0.001	18	12	2.62
16	10	748 410 005	749 410 005	0.001	21	16	2.62
20	15	748 410 006	749 410 006	0.001	27	20	3.53
25	20	748 410 007	749 410 007	0.002	35	28	3.53
32	25	748 410 008	749 410 008	0.002	40	33	3.53
40	32	748 410 009	749 410 009	0.007	51	41	5.34
50	40	748 410 010	749 410 010	0.001	58	47	5.34
63	50	748 410 011	749 410 011	0.010	70	60	5.34
75	65	748 410 014	749 410 014	0.012	93	82	5.34
90	80	748 410 015	749 410 015	0.015	112	101	5.34
* 90	80	748 410 248	749 410 248	0.020	105	95	5.34
110	100	748 410 016	749 410 016	0.031	134	120	6.99

Tank adaptors

610502

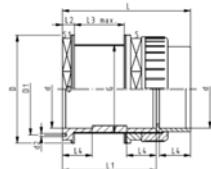

Tank adaptor for fix position stop PVC-U, Union end with socket metric

Model:

- End connection: union with solvent cement socket, metric
- Gaskets: flat gaskets EPDM
- Washer: PP
- Run-out holes: Two holes in octagonal head
- FPM flat gaskets available for tank adaptor type 050

d [mm]	PN	Code	kg
16	16	161 050 245	0.064
20	16	161 050 246	0.070
25	16	161 050 247	0.100
32	16	161 050 248	0.196
40	16	161 050 249	0.328
50	16	161 050 250	0.395
63	16	161 050 251	0.530

d [mm]	d2 [mm]	D [mm]	D1 [mm]	L [mm]	L1 [mm]	L2 [mm]	L3 max [mm]	L4 [mm]	G [inch]	S [mm]	S1 [mm]	Diameter of bore in tank side [mm]
16	5	44	29	77	58	11	19	14	¾	32	40	28
20	5	54	35	83	61	12	17	16	1	40	50	35
25	5	60	42	90	65	13	18	19	1 ¼	50	55	43
32	5	69	49	95	67	13	19	22	1 ½	56	65	49
40	5	84	59	104	72	13	16	26	2	69	80	61
50	5	92	70	113	76	15	16	31	2 ¼	76	85	67
63	5	108	82	128	84	15	19	38	2 ¾	95	100	83

610503

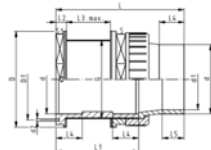

Tank adaptor for fix position stop PVC-U, Union end with spigot / reducing socket metric

Model:

- End connection: union with union end spigot/reducing socket, metric
- Gaskets: flat gaskets EPDM
- Washer: PP
- Run-out holes: Two holes in octagonal head
- FPM flat gaskets available for tank adaptor type 050

d [mm]	d1 [mm]	PN	EPDM Code	kg
16	12	16	161 050 345	0.068
20	16	16	161 050 346	0.102
25	20	16	161 050 347	0.157
32	25	16	161 050 348	0.220
40	32	16	161 050 349	0.353
50	40	16	161 050 350	0.438
63	50	16	161 050 351	0.680

table continued next page

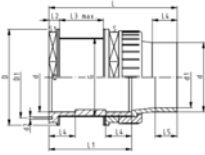

d [mm]	d2 [mm]	D [mm]	D1 [mm]	L [mm]	L1 [mm]	L2 [mm]	L3 max [mm]	L4 [mm]	L5 [mm]	G [inch]	S [mm]	S1 [mm]	Diameter of bore in tank side [mm]
16	5	44	29	96	58	11	19	14	12	¾	32	40	28
20	5	54	35	104	61	12	17	16	14	1	40	50	35
25	5	60	42	112	65	13	18	19	16	1 ¼	50	55	43
32	5	69	49	119	67	13	19	22	19	1 ½	56	65	49
40	5	84	59	132	72	13	16	26	22	2	69	80	61
50	5	92	70	145	76	15	16	31	26	2 ¼	76	85	67
63	5	108	82	163	84	15	19	38	31	2 ¾	95	100	83

Branch and tapping saddles

Branch Saddle

Model:



- For PVC pipes
- Top saddle for solvent cement bonding
- This article is also available upon request in inch sizes according to BS 3505:1968 under cat. no. 21 116
- Outlet with solvent cement socket
- For operating pressure up to 10 bar water

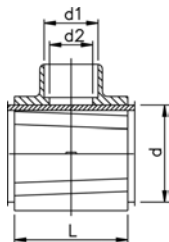

d [mm]	Code	kg	d1 [mm]	d2 [mm]	Tapping-Ø [mm]	L [mm]
63	161 110 035	0.690	40	31	30	105
63	161 110 036	0.652	50	31	30	105
90	161 110 055	0.817	40	49	30	105
90	161 110 056	0.851	50	40	39	105
90	161 110 057	0.798	63	40	39	105
110	161 110 065	0.921	40	31	30	105
110	161 110 066	0.944	50	40	39	105
110	161 110 067	0.986	63	40	39	105
160	161 110 095	1.240	40	31	30	120
160	161 110 096	1.234	50	40	39	120
160	161 110 097	1.475	63	49	48	120
225	161 110 116	1.570	50	40	39	120
225	161 110 117	1.573	63	49	48	120

21 111

Branch saddle



- Outlet with solvent cement socket metric
- For operating pressure up to 10 bar water
- Top saddle with rubber seal
- Seal: NBR (Nitrile-Rubber) shore hardness: 60 ±5 Shore A

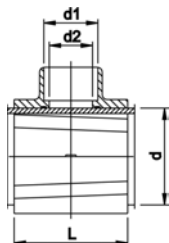

d [mm]	Code	kg	d1 [mm]	d2 [mm]	L [mm]
63	161 111 035	0.697	40	22	105
63	161 111 036	0.733	50	22	105
75	161 111 046	0.775	50	31	105
90	161 111 055	0.829	40	31	105
90	161 111 056	0.867	50	31	105
110	161 111 065	0.935	40	31	105
110	161 111 066	0.970	50	40	105
110	161 111 067	1.003	63	40	105
160	161 111 095	1.252	40	31	120
160	161 111 096	1.281	50	40	120
160	161 111 097	1.488	63	40	120
225	161 111 116	1.587	50	40	120
225	161 111 117	1.756	63	40	120

21 110 200

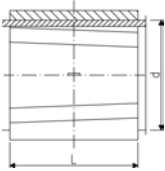

Repair saddle

- For operating pressure up to 10 bar water
- For repair of damaged pipes
- Saddle halves can be solvent cemented
- Cementing only possible on dry mains without pressure

d [mm]	Code	kg	Max. pipe aperture [mm]	L [mm]	
63	161 110 230	0.663	39	105	
90	161 110 250	0.761	48	105	
110	161 110 260	0.900	48	105	
160	161 110 290	1.369	60	120	
225	161 110 310	1.490	60	120	

61 49 06



Backing nut PVC-U

Model:

- With parallel female thread Rp
- Spare part for tank adaptor type 050

Rp [inch]	Code	kg	D [mm]	L [mm]	
½	161 280 026	0.009	37	13	
¾	161 280 027	0.012	42	13	
1	161 280 113	0.030	55	15	
1 ¼	161 280 114	0.030	59	17	
1 ½	161 280 115	0.050	70	19	
2	161 280 116	0.080	94	23	

POLY16 Plus CLAMP SADDLES

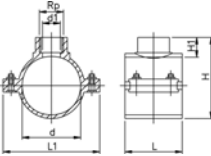

654 - Blue clamp saddles with stainless steel reinforcing ring, flat gasket and galvanized bolts and nuts (PN16-PN10)

- water PN16-10
- suitable for PE and PVC pipes
- female thread: ISO 7 (parallel)
- material: PP
- gasket: O-ring with flat lip (NBR)
- reinforcement ring: stainless steel AISI430
- bolts and nuts : galvanized
- colour: blue
- B= N° of bolts
- M= bolt type
- (*) with O-ring gasket

d [mm]	Rp [inch]	PN	B	M	Code	kg
* 20	1/2	16	2	M8X40	158 001 041	0.119
* 25	1/2	16	2	M8X30	158 001 042	0.110
* 25	3/4	16	2	M8X30	158 001 043	0.123
* 32	1/2	16	2	M8X30	158 001 044	0.103
* 32	3/4	16	2	M8X30	158 001 045	0.115
* 32	1	16	2	M8X40	158 001 046	0.162
40	1/2	16	2	M8X40	158 001 047	0.135
40	3/4	16	2	M8X40	158 001 048	0.146
40	1	16	2	M8X40	158 001 049	0.153
50	1/2	16	4	M8X40	158 001 050	0.196
50	3/4	16	4	M8X40	158 001 051	0.209
50	1	16	4	M8X40	158 001 052	0.217
50	1 1/4	16	4	M8X40	158 001 053	0.221
63	1/2	16	4	M8X40	158 001 054	0.212
63	3/4	16	4	M8X40	158 001 055	0.222
63	1	16	4	M8X40	158 001 056	0.228
63	1 1/4	16	4	M8X40	158 001 058	0.268
63	1 1/2	16	4	M8X40	158 001 057	0.275
75	1/2	16	4	M8X60	158 001 059	0.364
75	3/4	16	4	M8X60	158 001 060	0.376
75	1	16	4	M8X60	158 001 061	0.384
75	1 1/4	16	4	M8X60	158 001 063	0.421
75	1 1/2	16	4	M8X60	158 001 062	0.428
75	2	16	4	M8X60	158 001 064	0.437
90	1/2	16	4	M8X60	158 001 065	0.412
90	3/4	16	4	M8X60	158 001 066	0.421
90	1	16	4	M8X60	158 001 067	0.432
90	1 1/4	16	4	M8X60	158 001 069	0.472
90	1 1/2	16	4	M8X60	158 001 068	0.474
90	2	16	4	M8X60	158 001 070	0.481
110	1/2	16	6	M8X50	158 001 071	0.511
110	3/4	16	6	M8X50	158 001 072	0.523
110	1	16	6	M8X50	158 001 073	0.533
110	1 1/4	16	6	M8X50	158 001 075	0.565
110	1 1/2	16	6	M8X50	158 001 074	0.566

table continued next page

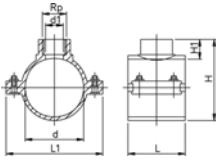

d [mm]	Rp [inch]	PN	B	M	Code	kg
110	2	16	6	M8X50	158 001 076	0.570
110	3	6	6	M8x70	158 001 077	1.108
125	½	16	6	M8X50	158 001 078	0.578
125	¾	16	6	M8X50	158 001 079	0.590
125	1	16	6	M8X50	158 001 080	0.592
125	1 ¼	16	6	M8X50	158 001 082	0.629
125	1 ½	16	6	M8X50	158 001 081	0.627
125	2	16	6	M8X50	158 001 083	0.640
125	3	6	6	M8X70	158 001 084	1.009
125	4	6	6	M8X70	158 001 085	1.051
140	½	16	6	M8X70	158 001 086	0.830
140	¾	16	6	M8X70	158 001 087	0.843
140	1	16	6	M8X70	158 001 088	0.849
140	1 ¼	16	6	M8X70	158 001 090	0.880
140	1 ½	16	6	M8X70	158 001 089	0.892
140	2	16	6	M8X70	158 001 091	0.898
140	3	10	6	M8X70	158 001 092	1.132
140	4	10	6	M8X70	158 001 093	1.196
160	½	16	6	M8X70	158 001 094	0.899
160	¾	16	6	M8X70	158 001 095	0.908
160	1	16	6	M8X70	158 001 096	0.917
160	1 ¼	16	6	M8X70	158 001 098	0.950
160	1 ½	16	6	M8X70	158 001 097	0.954
160	2	16	6	M8X70	158 001 099	0.956
160	3	10	6	M8X70	158 001 100	1.185
160	4	10	6	M8X70	158 001 101	1.262
* 180	1	10	6	M10X80	158 001 102	1.980
* 180	1 ¼	10	6	M10X80	158 001 104	2.013
* 180	1 ½	10	6	M10X80	158 001 103	2.007
* 180	2	10	6	M10X80	158 001 105	2.018
* 180	3	10	6	M10X80	158 001 106	2.043
* 180	4	10	6	M10X80	158 001 107	2.092
* 200	1 ½	10	6	M10X80	158 001 108	1.966
* 200	2	10	6	M10X80	158 001 109	1.946
* 200	3	10	6	M10X80	158 001 110	1.980
* 200	4	10	6	M10X80	158 001 111	2.020
* 225	1 ½	10	6	M10X80	158 001 112	2.049
* 225	2	10	6	M10X80	158 001 113	2.050
* 225	3	10	6	M10X80	158 001 114	2.150
* 225	4	10	6	M10X80	158 001 115	2.184
* 250	2	10	6	M10X80	158 001 116	2.472
* 250	3	10	6	M10X80	158 001 117	2.466
* 250	4	10	6	M10X80	158 001 118	2.478
280	2	10	6	M10X160	158 001 119	3.440
* 280	3	10	6	M10X160	158 001 120	3.543
* 280	4	10	6	M10X160	158 001 121	3.585
315	2	10	6	M10X110	158 001 122	4.156
* 315	3	10	6	M10X110	158 001 123	4.267
* 315	4	10	6	M10X110	158 001 124	4.279

table continued next page

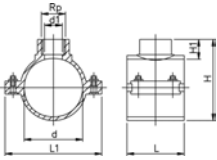

d [mm]	Rp [inch]	d1 [mm]	L [mm]	L1 [mm]	H [mm]	H1 [mm]
* 20	1/2	12	46	77	59	26
* 25	1/2	13	49	79	58	15
* 25	3/4	13	49	79	58	15
* 32	1/2	14	49	79	62	20
* 32	3/4	14	49	79	62	20
* 32	1	14	62	87	70	20
40	1/2	21	62	86	71	20
40	3/4	21	62	86	71	20
40	1	21	62	86	70	19
50	1/2	21	62	86	82	20
50	3/4	21	62	86	82	20
50	1	21	62	86	82	20
50	1 1/4	21	62	86	82	20
63	1/2	18	62	101	96	21
63	3/4	24	62	101	96	21
63	1	31	62	101	96	21
63	1 1/4	31	62	101	96	21
63	1 1/2	31	62	101	96	21
75	1/2	16	79	123	102	14
75	3/4	21	79	123	104	16
75	1	27	79	123	107	19
75	1 1/4	35	79	123	109	21
75	1 1/2	42	79	123	109	21
75	2	53	79	123	112	24
90	1/2	16	87	138	116	14
90	3/4	21	87	138	118	16
90	1	27	87	138	121	19
90	1 1/4	35	87	138	123	21
90	1 1/2	42	87	138	123	21
90	2	53	87	138	126	24
110	1/2	15	99	152	150	23
110	3/4	20	99	152	150	23
110	1	26	99	152	150	23
110	1 1/4	35	99	152	150	23
110	1 1/2	41	99	152	150	23
110	2	51	99	152	150	23
110	3	85	99	152	150	23
125	1/2	15	101	166	169	24
125	3/4	20	101	166	169	24
125	1	26	101	166	169	24
125	1 1/4	35	101	166	168	23
125	1 1/2	41	101	166	168	23
125	2	50	101	166	168	23
125	3	85	139	178	180	37
125	4	90	139	178	181	38
140	1/2	18	114	207	191	25
140	3/4	24	114	207	191	25
140	1	30	114	207	191	25
140	1 1/4	38	114	207	191	25
140	1 1/2	45	114	207	191	24
140	2	50	114	207	191	24

table continued next page

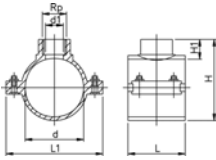

d [mm]	Rp [inch]	d1 [mm]	L [mm]	L1 [mm]	H [mm]	H1 [mm]
140	3	85	142	208	201	38
140	4	90	142	208	201	38
160	1/2	18	114	226	215	24
160	3/4	24	114	226	215	24
160	1	30	114	226	215	24
160	1 1/4	37	114	226	215	24
160	1 1/2	45	114	226	215	24
160	2	51	114	226	215	24
160	3	84	142	228	222	38
160	4	90	142	228	222	38
* 180	1	30	169	262	265	38
* 180	1 1/4	36	169	262	265	38
* 180	1 1/2	54	169	262	265	38
* 180	2	54	169	262	265	38
* 180	3	85	169	262	265	38
* 180	4	103	169	262	267	40
* 200	1 1/2	45	169	262	265	38
* 200	2	54	169	262	265	38
* 200	3	85	169	262	265	38
* 200	4	103	169	262	267	40
* 225	1 1/2	45	145	287	287	26
* 225	2	51	145	287	287	26
* 225	3	85	174	287	295	37
* 225	4	103	174	287	295	38
* 250	2	55	178	310	314	38
* 250	3	85	178	310	314	38
* 250	4	103	178	310	314	38
280	2	51	179	335	326	31
* 280	3	78	179	335	338	41
* 280	4	98	179	335	338	46
315	2	51	246	390	350	31
* 315	3	78	246	390	363	41
* 315	4	98	246	390	363	46

Ball valves 546

Ball valve type 546 PVC-U With solvent cement sockets Inch BS

Model:

- For easy installation and removal
- z-dimension, valve end and union nut are **not compatible** with type 346 (DN10/15-50) resp. type 370 (DN65-100)
- Ball seals PTFE
- Without mounting inserts

Option:

- Individual configuration of the valve (see diagram)
- Multifunctional module with integrated limit switches
- Pneumatic or electric actuators from +GF+

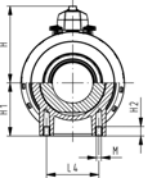
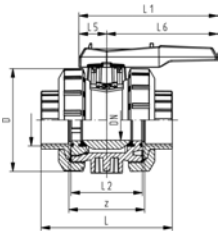
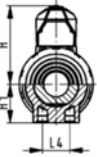
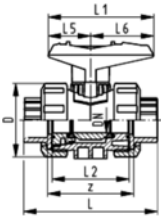

Inch	DN [mm]	PN	kv-value ($\Delta p=1$ bar) [l/min]	EPDM Code	FPM Code	kg
3/8	10	16	71	161 546 201	161 546 211	0.150
1/2	15	16	185	161 546 202	161 546 212	0.150
3/4	20	16	350	161 546 203	161 546 213	0.230
1	25	16	700	161 546 204	161 546 214	0.336
1 1/4	32	16	1000	161 546 205	161 546 215	0.585
1 1/2	40	16	1600	161 546 206	161 546 216	0.815
2	50	16	3100	161 546 207	161 546 217	1.577
	65	16	5000	161 546 008	161 546 018	3.794
3	80	16	7000	161 546 209	161 546 219	7.400
4	100	16	11000	161 546 210	161 546 220	11.600

Inch	D [mm]	H [mm]	H1 [mm]	L [mm]	L1 [mm]	L2 [mm]	L4 [mm]	L5 [mm]	L6 [mm]	z [mm]
3/8	50	57	27	92	77	56	25	32	45	60
1/2	50	57	27	95	77	56	25	32	45	60
3/4	58	67	30	110	97	65	25	39	58	69
1	68	73	36	123	97	71	25	39	58	75
1 1/4	84	90	44	146	128	85	45	54	74	89
1 1/2	97	97	51	157	128	89	45	54	74	97
2	124	116	64	183	152	101	45	66	87	110
	166	149	85	233	270	136	70	64	206	144
3	200	161	105	254	270	141	70	64	206	151
4	238	178	123	301	320	164	120	64	256	174



DN10/15 - 50



Ball valve type 546 PVC-U
With mounting inserts
With solvent cement sockets inch BS

Model:

- For easy installation and removal
- z-dimension, valve end and union nut are **not compatible** with type 346 (DN10/15-50) resp. type 370 (DN65-100)
- Ball seals PTFE
- Integrated stainless steel mounting inserts

Option:

- Individual configuration of the valve (see diagram)
- Multifunctional module with integrated limit switches
- Pneumatic or electric actuators from +GF+

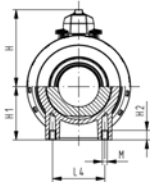
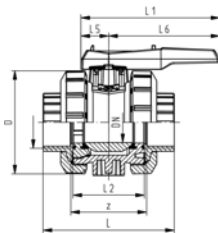
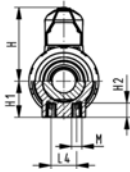
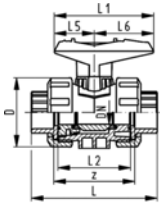

Inch	DN [mm]	PN	kv-value ($\Delta p=1$ bar) [l/min]	EPDM Code	FPM Code	kg
3/8	10	16	71	161 546 241	161 546 251	0.150
1/2	15	16	185	161 546 242	161 546 252	0.150
3/4	20	16	350	161 546 243	161 546 253	0.230
1	25	16	700	161 546 244	161 546 254	0.330
1 1/4	32	16	1000	161 546 245	161 546 255	0.585
1 1/2	40	16	1600	161 546 246	161 546 256	0.862
2	50	16	3100	161 546 247	161 546 257	1.582
2 1/2	65	16	5000	161 546 068	161 546 078	3.563
3	80	16	7000	161 546 249	161 546 259	5.404
4	100	16	11000	161 546 250	161 546 260	8.581

Inch	D [mm]	H [mm]	H1 [mm]	H2 [mm]	L [mm]	L1 [mm]	L2 [mm]	L4 [mm]	L5 [mm]	L6 [mm]	M	z [mm]
3/8	50	57	27	12	92	77	56	25	32	45	6	67
1/2	50	57	27	12	95	77	56	25	32	45	6	61
3/4	58	67	30	12	110	97	65	25	39	58	6	70
1	68	73	36	12	123	97	71	25	39	58	6	76
1 1/4	84	90	44	15	146	128	85	45	54	74	8	90
1 1/2	97	97	51	15	157	128	89	45	54	74	8	94
2	124	116	64	15	183	152	101	45	66	87	8	107
2 1/2	166	149	85	15	233	270	136	70	64	206	8	144
3	200	161	105	15	254	270	141	70	64	206	8	151
4	238	178	123	22	301	320	164	120	64	256	12	174



DN10/15 - 50



Ball valve type 546 PVC-U With lockable handle With solvent cement sockets Inch BS

Model:

- For easy installation and removal
- z-dimension, valve end and union nut are **not compatible** with type 346 (DN10/15-50) resp. type 370 (DN65-100)
- Ball seals PTFE
- Integrated stainless steel mounting inserts
- Lockable hand lever with ratchet settings

Option:

- Individual configuration of the valve (see diagram)
- Multifunctional module with integrated limit switches
- Pneumatic or electric actuators from +GF+

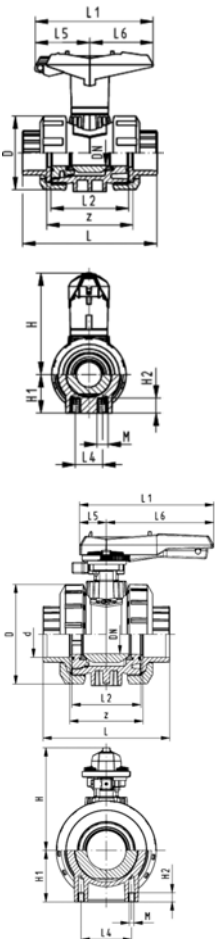

Inch	DN	PN	kv-value ($\Delta p=1$ bar)	EPDM Code	FPM Code	kg	
	[mm]		[l/min]				
3/8	10	16	71	161 546 221	161 546 231	0.165	
1/2	15	16	185	161 546 222	161 546 232	0.165	
3/4	20	16	350	161 546 223	161 546 233	0.255	
1	25	16	700	161 546 224	161 546 234	0.355	
1 1/4	32	16	1000	161 546 225	161 546 235	0.625	
1 1/2	40	16	1600	161 546 226	161 546 236	0.855	
2	50	16	3100	161 546 227	161 546 237	1.535	
2 1/2	65	16	5000	161 546 088	161 546 098	5.200	
3	80	16	7000	161 546 229	161 546 239	7.700	
4	100	16	11000	161 546 230	161 546 240	12.000	

Inch	D	H	H1	H2	L	L1	L2	L4	L5	L6	M	z
	[mm]	[mm]	[mm]	[mm]	[mm]	[mm]	[mm]	[mm]	[mm]	[mm]		[mm]
3/8	50	79	27	12	92	87	56	25	42	45	M6	60
1/2	50	79	27	12	95	87	56	25	42	45	M6	60
3/4	58	88	30	12	110	108	65	25	50	58	M6	69
1	68	94	36	12	123	108	71	25	50	58	M6	75
1 1/4	84	113	44	15	146	140	85	45	66	75	M8	89
1 1/2	97	119	51	15	157	140	89	45	66	75	M8	97
2	124	141	64	15	183	165	101	45	78	87	M8	110
2 1/2	166	224	85	15	233	270	136	70	64	206	M8	144
3	200	235	105	15	254	270	141	70	64	206	M8	151
4	238	245	123	22	301	320	164	120	64	256	M12	174



DN10/15 - 50



Ball valve type 546 PVC-U With lockable handle With solvent cement sockets metric

Model:

- For easy installation and removal
- Ball seals PTFE
- Integrated stainless steel mounting inserts
- z-dimension, valve end and union nut are **not compatible** with type 346 (DN10/15-50) resp. type 370 (DN65-100)
- Lockable hand lever with ratchet settings

Option:

- Individual configuration of the valve (see diagram)
- Multifunctional module with integrated limit switches
- Pneumatic or electric actuators from +GF+

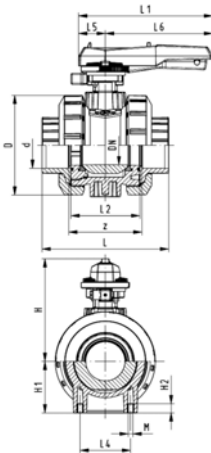
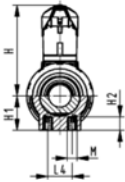
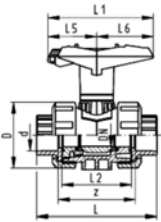

d [mm]	Inch	DN [mm]	PN	kv-value ($\Delta p=1$ bar) [l/min]	EPDM Code	FPM Code	kg
16		10	16	71	161 546 081	161 546 091	0.165
20		15	16	185	161 546 082	161 546 092	0.165
25		20	16	350	161 546 083	161 546 093	0.255
32		25	16	700	161 546 084	161 546 094	0.355
40		32	16	1000	161 546 085	161 546 095	0.640
50		40	16	1600	161 546 086	161 546 096	0.840
63		50	16	3100	161 546 087	161 546 097	1.500
75	2 ½	65	16	5000	161 546 088	161 546 098	5.200
90		80	16	7000	161 546 089	161 546 099	7.700
110		100	16	11000	161 546 090	161 546 100	12.000

d [mm]	D [mm]	H [mm]	H1 [mm]	H2 [mm]	L [mm]	L1 [mm]	L2 [mm]	L4 [mm]	L5 [mm]	L6 [mm]	M	z [mm]
16	50	79	27	12	92	87	56	25	42	45	M6	64
20	50	79	27	12	95	87	56	25	42	45	M6	64
25	58	88	30	12	110	108	65	25	50	58	M6	72
32	68	94	36	12	123	108	71	25	50	58	M6	79
40	84	113	44	15	146	140	85	45	66	75	M8	94
50	97	119	51	15	157	140	89	45	66	75	M8	95
63	124	141	64	15	183	165	101	45	78	87	M8	107
75	166	224	85	15	233	270	136	70	64	206	M8	144
90	200	235	105	15	254	270	141	70	64	206	M8	151
110	238	245	123	22	301	320	164	120	64	256	M12	174



DN10/15 - 50



Ball valve type 546 PVC-U With mounting inserts With solvent cement sockets metric

Model:

- For easy installation and removal
- Ball seals PTFE
- Integrated stainless steel mounting inserts
- z-dimension, valve end and union nut are **not compatible** with type 346 (DN10/15-50) resp. type 370 (DN65-100)

Option:

- Individual configuration of the valve (see diagram)
- Multifunctional module with integrated limit switches
- Pneumatic or electric actuators from +GF+

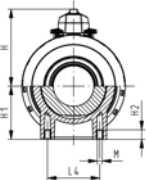
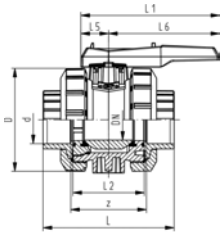
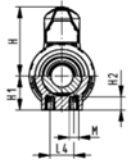
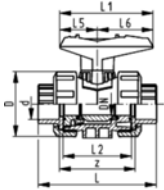

d [mm]	Inch	DN [mm]	PN	kv-value ($\Delta p=1$ bar) [l/min]	EPDM Code	FPM Code	kg
16		10	16	71	161 546 061	161 546 071	0.156
20		15	16	185	161 546 062	161 546 072	0.158
25		20	16	350	161 546 063	161 546 073	0.242
32		25	16	700	161 546 064	161 546 074	0.345
40		32	16	1000	161 546 065	161 546 075	0.615
50		40	16	1600	161 546 066	161 546 076	0.844
63		50	16	3100	161 546 067	161 546 077	1.552
75	2 1/2	65	16	5000	161 546 068	161 546 078	3.563
90		80	16	7000	161 546 069	161 546 079	5.376
110		100	16	11000	161 546 070	161 546 080	11.600

d [mm]	D [mm]	H [mm]	H1 [mm]	H2 [mm]	L [mm]	L1 [mm]	L2 [mm]	L4 [mm]	L5 [mm]	L6 [mm]	M	z [mm]
16	50	57	27	12	92	77	56	25	32	45	6	64
20	50	57	27	12	95	77	56	25	32	45	6	64
25	58	67	30	12	110	97	65	25	39	58	6	72
32	68	73	36	12	123	97	71	25	39	58	6	79
40	84	90	44	15	146	128	85	45	54	74	8	94
50	97	97	51	15	157	128	89	45	54	74	8	95
63	124	116	64	15	183	152	101	45	66	87	8	107
75	166	149	85	15	233	270	136	70	64	206	8	144
90	200	161	105	15	254	270	141	70	64	206	8	151
110	238	178	123	22	301	320	164	120	64	256	12	174



DN10/15 - 50

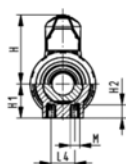
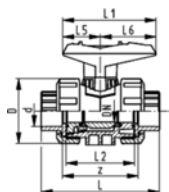

Ball valve type 546 PVC-U With mounting inserts With fusion sockets PE100 metric

Model:

- For easy installation and removal
- Ball seals PTFE
- Integrated stainless steel mounting inserts
- z-dimension, valve end and union nut are not compatible with type 346

Option:

- Individual configuration of the valve (see diagram)
- Multifunctional module with integrated limit switches
- Pneumatic or electric actuators from +GF+

d [mm]	DN [mm]	PN	kv-value ($\Delta p=1$ bar) [l/min]	EPDM Code	FPM Code	kg
16	10	16	71	161 546 761	161 546 771	0.150
20	15	16	185	161 546 762	161 546 772	0.151
25	20	16	350	161 546 763	161 546 773	0.220
32	25	16	700	161 546 764	161 546 774	0.329
40	32	16	1000	161 546 765	161 546 775	0.550
50	40	16	1600	161 546 766	161 546 776	0.750
63	50	16	3100	161 546 767	161 546 777	1.360

d [mm]	D [mm]	H [mm]	H1 [mm]	H2 [mm]	L [mm]	L1 [mm]	L2 [mm]	L4 [mm]	L5 [mm]	L6 [mm]	M	z [mm]
16	50	57	27	12	93	77	56	25	32	45	M6	67
20	50	57	27	12	95	77	56	25	32	45	M6	66
25	58	67	30	12	108	97	65	25	39	58	M6	77
32	68	73	36	12	119	97	71	25	39	58	M6	83
40	84	90	44	15	137	128	85	45	54	74	M8	99
50	97	97	51	15	147	128	89	45	54	74	M8	105
63	124	116	64	15	168	152	101	45	66	87	M8	113



DN10/15 - 50



Ball valve type 546 PVC-U
With mounting inserts
With butt fusion spigots long PE100 SDR11 metric

Model:

- For easy installation and removal
- Ball seals PTFE
- Integrated stainless steel mounting inserts
- z-dimension, valve end and union nut are **not compatible** with type 346 (DN10/15-50) resp. type 370 (DN65-100)

Option:

- Individual configuration of the valve (see diagram)
- Multifunctional module with integrated limit switches
- Pneumatic or electric actuators from +GF+

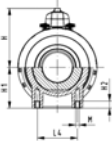
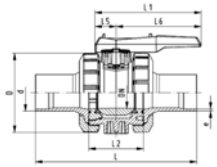
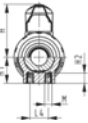
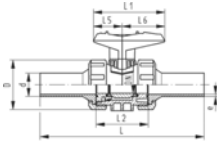

d [mm]	DN [mm]	PN	kv-value (Δp=1 bar) [l/min]	EPDM Code	FPM Code	kg
20	15	16	185	161 546 822	161 546 832	0.150
25	20	16	350	161 546 823	161 546 833	0.220
32	25	16	700	161 546 824	161 546 834	0.310
40	32	16	1000	161 546 825	161 546 835	0.550
50	40	16	1600	161 546 826	161 546 836	0.750
63	50	16	3100	161 546 827	161 546 837	1.360
75	65	16	5000	161 546 828	161 546 838	5.000
90	80	16	7000	161 546 829	161 546 839	7.500
110	100	16	11000	161 546 830	161 546 840	11.800

d [mm]	D [mm]	H [mm]	H1 [mm]	H2 [mm]	L [mm]	L1 [mm]	L2 [mm]	L4 [mm]	L5 [mm]	L6 [mm]	M	e [mm]
20	50	57	27	12	193	77	56	25	32	45	M6	2,25
25	58	67	30	12	216	97	65	25	39	58	M6	2,3
32	68	73	36	12	223	97	71	25	39	58	M6	2,9
40	84	90	44	15	249	128	85	45	54	74	M8	3,7
50	97	97	51	15	271	128	89	45	54	74	M8	4,6
63	124	116	64	15	321	152	101	45	66	87	M8	5,8
75	166	149	85	15	386	270	136	70	64	206	M8	6,8
90	200	161	105	15	421	270	141	70	64	206	M8	8,2
110	238	178	123	22	484	320	164	120	64	256	M12	10,0



Ball valve type 546 PVC-U
With mounting inserts
With backing flanges PVC-U metric

Model:

- For easy installation and removal
- Ball seals PTFE
- Integrated stainless steel mounting inserts
- z-dimension, valve end and union nut are **not compatible** with type 346 (DN10/15-50) resp. type 370 (DN65-100)
- Overall length according to EN 558
- Connecting dimension: ISO 7005 PN10, EN 1092 PN10, DIN 2501 PN10

Option:

- Individual configuration of the valve (see diagram)
- Multifunctional module with integrated limit switches
- Pneumatic or electric actuators from +GF+

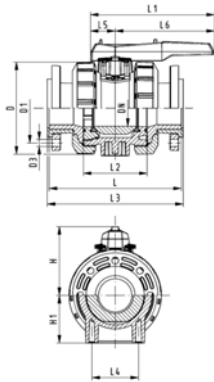

d [mm]	DN [mm]	PN	kv-value (Δp=1 bar) [l/min]	EPDM Code	FPM Code	kg	
75	65	10	5000	161 546 108	161 546 118	7.200	
90	80	10	7000	161 546 109	161 546 119	7.008	
110	100	10	11000	161 546 110	161 546 120	16.500	

d [mm]	D [mm]	H [mm]	H1 [mm]	H2 [mm]	L [mm]	L1 [mm]	L2 [mm]	L3 [mm]	L4 [mm]	L5 [mm]	L6 [mm]	M
75	166	149	85	15	284	270	136	290	70	64	206	M8
90	200	161	105	15	300	270	141	310	70	64	206	M8
110	238	178	123	22	340	320	164	350	120	64	256	M12



DN10/15 - 50



Ball valve type 546 PVC-U With solvent cement sockets metric

Model:

- For easy installation and removal
- Ball seals PTFE
- Without mounting inserts
- z-dimension, valve end and union nut are **not compatible** with type 346 (DN10/15-50) resp. type 370 (DN65-100)

Option:

- Individual configuration of the valve (see diagram)
- Multifunctional module with integrated limit switches
- Pneumatic or electric actuators from +GF+

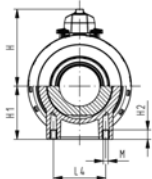
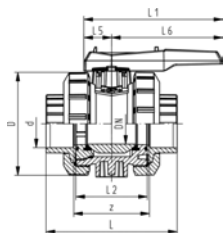
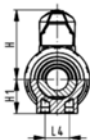
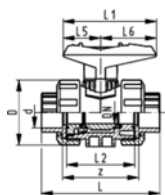

d [mm]	DN [mm]	PN	kv-value ($\Delta p=1$ bar) [l/min]	EPDM Code	FPM Code	kg
16	10	16	71	161 546 001	161 546 011	0.150
20	15	16	185	161 546 002	161 546 012	0.152
25	20	16	350	161 546 003	161 546 013	0.237
32	25	16	700	161 546 004	161 546 014	0.343
40	32	16	1000	161 546 005	161 546 015	0.603
50	40	16	1600	161 546 006	161 546 016	0.851
63	50	16	3100	161 546 007	161 546 017	1.542
75	65	16	5000	161 546 008	161 546 018	3.794
90	80	16	7000	161 546 009	161 546 019	7.400
110	100	16	11000	161 546 010	161 546 020	11.600

d [mm]	D [mm]	H [mm]	H1 [mm]	L [mm]	L1 [mm]	L2 [mm]	L4 [mm]	L5 [mm]	L6 [mm]	z [mm]
16	50	57	27	92	77	56	25	32	45	64
20	50	57	27	95	77	56	25	32	45	64
25	58	67	30	110	97	65	25	39	58	72
32	68	73	36	123	97	71	25	39	58	79
40	84	90	44	146	128	85	45	54	74	94
50	97	97	51	157	128	89	45	54	74	95
63	124	116	64	183	152	101	45	66	87	107
75	166	149	85	233	270	136	70	64	206	144
90	200	161	105	254	270	141	70	64	206	151
110	238	178	123	301	320	164	120	64	256	174



DN10/15 - 50



Ball valve type 546 PVC-U With solvent cement spigots metric

Model:

- For easy installation and removal
- Ball seals PTFE
- Without mounting inserts
- z-dimension, valve end and union nut are **not compatible** with type 346 (DN10/15-50) resp. type 370 (DN65-100)

Option:

- Individual configuration of the valve (see diagram)
- Multifunctional module with integrated limit switches
- Pneumatic or electric actuators from +GF+

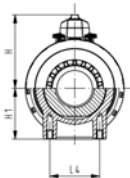
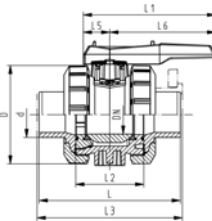
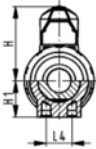
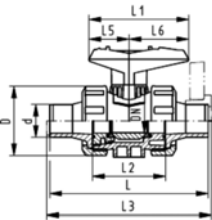

d [mm]	DN [mm]	PN	kv-value (Δp=1 bar) [l/min]	EPDM Code	FPM Code	kg
16	10	16	71	161 546 041	161 546 051	0.155
20	15	16	185	161 546 042	161 546 052	0.155
25	20	16	350	161 546 043	161 546 053	0.240
32	25	16	700	161 546 044	161 546 054	0.345
40	32	16	1000	161 546 045	161 546 055	0.615
50	40	16	1600	161 546 046	161 546 056	0.840
63	50	16	3100	161 546 047	161 546 057	1.545
75	65	16	5000	161 546 048	161 546 058	5.100
90	80	16	7000	161 546 049	161 546 059	7.500
110	100	16	11000	161 546 050	161 546 060	11.900

d [mm]	D [mm]	H [mm]	H1 [mm]	L [mm]	L1 [mm]	L2 [mm]	L3 [mm]	L4 [mm]	L5 [mm]	L6 [mm]
16	50	57	27	114	77	56		25	32	45
20	50	57	27	124	77	56	130	25	32	45
25	58	67	30	144	97	65	150	25	39	58
32	68	73	36	154	97	71	160	25	39	58
40	84	90	44	174	128	85	180	45	54	74
50	97	97	51	194	128	89	200	45	54	74
63	124	116	64	224	152	101	230	45	66	87
75	166	149	85	284	270	136	290	70	64	206
90	200	161	105	300	270	141	310	70	64	206
110	238	178	123	340	320	164	350	120	64	256



DN10/15 - 50



Ball valve type 546 PVC-U With threaded sockets Rp

Model:

- For easy installation and removal
- Ball seals PTFE
- Without mounting inserts
- z-dimension, valve end and union nut are **not compatible** with type 346 (DN10/15-50) resp. type 370 (DN65-100)

Option:

- Individual configuration of the valve (see diagram)
- Multifunctional module with integrated limit switches
- Pneumatic or electric actuators from +GF+

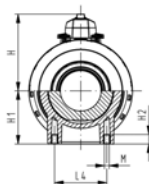
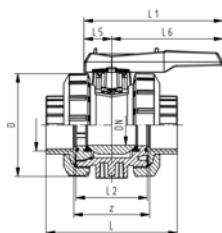
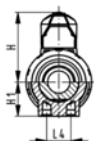
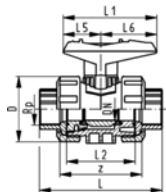

Rp [inch]	DN [mm]	PN	kv-value ($\Delta p=1$ bar) [l/min]	EPDM Code	FPM Code	kg
3/8	10	10	71	161 546 021	161 546 031	0.150
1/2	15	10	185	161 546 022	161 546 032	0.150
3/4	20	10	350	161 546 023	161 546 033	0.230
1	25	10	700	161 546 024	161 546 034	0.330
1 1/4	32	10	1000	161 546 025	161 546 035	0.600
1 1/2	40	10	1600	161 546 026	161 546 036	0.800
2	50	10	3100	161 546 027	161 546 037	1.460
2 1/2	65	10	5000	161 546 028	161 546 038	5.000
3	80	10	7000	161 546 029	161 546 039	7.500
4	100	10	11000	161 546 030	161 546 040	11.700

Rp [inch]	D [mm]	H [mm]	H1 [mm]	L [mm]	L1 [mm]	L2 [mm]	L4 [mm]	L5 [mm]	L6 [mm]	z [mm]
3/8	50	57	27	95	77	56	25	32	45	69
1/2	50	57	27	100	77	56	25	32	45	67
3/4	58	67	30	114	97	65	25	39	58	78
1	68	73	36	127	97	71	25	39	58	85
1 1/4	84	90	44	146	128	85	45	54	74	100
1 1/2	97	97	51	152	128	89	45	54	74	106
2	124	116	64	177	152	101	45	66	87	121
2 1/2	166	149	85	233	270	136	70	64	206	144
3	200	161	105	254	270	141	70	64	206	151
4	238	178	123	301	320	164	120	64	256	174



Ball valve type 546 PVC-U With fixed flanges PVC-U serrated metric

Model:

- For easy installation and removal
- Ball seals PTFE
- Without mounting inserts
- z-dimension, valve end and union nut are not compatible with type 346
- Overall length according to EN 558
- Connecting dimension: ISO 7005 PN10, EN 1092 PN10, DIN 2501 PN10

Option:

- Individual configuration of the valve (see diagram)
- Multifunctional module with integrated limit switches
- Pneumatic or electric actuators from +GF+

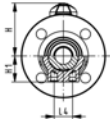
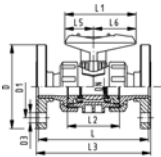

d [mm]	DN [mm]	PN	kv-value ($\Delta p=1$ bar) [l/min]	EPDM Code	FPM Code	kg
20	15	16	185	800 000 182	800 000 192	0.370
25	20	16	350	800 000 183	800 000 193	0.510
32	25	16	700	800 000 184	800 000 194	0.727
40	32	16	1000	800 000 185	800 000 195	1.230
50	40	16	1600	800 000 186	800 000 196	1.621
63	50	16	3100	800 000 187	800 000 197	2.653

d [mm]	D [mm]	D1 [mm]	D3 [mm]	H [mm]	H1 [mm]	L [mm]	L1 [mm]	L2 [mm]	L3 [mm]	L4 [mm]	L5 [mm]	L6 [mm]
20	95	65	14	57	27	124	77	56	130	25	32	45
25	105	75	14	67	30	144	97	65	150	25	39	58
32	115	85	14	73	36	154	97	71	160	25	39	58
40	140	100	18	90	44	174	128	85	180	45	54	74
50	150	110	18	97	51	194	128	89	200	45	54	74
63	165	125	18	116	64	224	152	101	230	45	66	87



DN10/15 - 50



Ball valve type 546 PVC-U
With mounting inserts
With solvent cement sockets Inch ASTM
Inclusive 2 threaded valve ends NPT

Model:

- For easy installation and removal
- z-dimension, valve end and union nut are **not compatible** with type 346 (DN10/15-50) resp. type 370 (DN65-100)
- Ball seals PTFE
- Integrated stainless steel mounting inserts
- Threaded valve ends are only enclosed for DN10/15-50

Option:

- Individual configuration of the valve (see diagram)
- Multifunctional module with integrated limit switches
- Pneumatic or electric actuators from +GF+

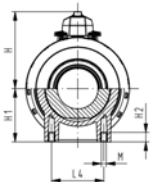
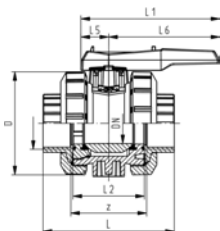
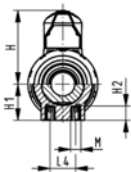
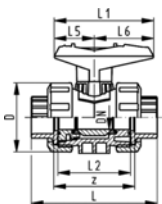

Inch	DN [mm]	PN	kv-value (Δp=1 bar) [l/min]	EPDM Code	FPM Code	kg
3/8	10	16	71	161 546 341	161 546 351	0.184
1/2	15	16	185	161 546 342	161 546 352	0.200
3/4	20	16	350	161 546 343	161 546 353	0.342
1	25	16	700	161 546 344	161 546 354	0.486
1 1/4	32	16	1000	161 546 345	161 546 355	0.740
1 1/2	40	16	1600	161 546 346	161 546 356	1.101
2	50	16	3100	161 546 347	161 546 357	1.934
2 1/2	65	16	5000	161 546 348	161 546 358	4.900
3	80	16	7000	161 546 349	161 546 359	7.400
4	100	16	11000	161 546 350	161 546 360	9.707

Inch	D [mm]	H [mm]	H1 [mm]	H2 [mm]	L [mm]	L1 [mm]	L2 [mm]	L4 [mm]	L5 [mm]	L6 [mm]	M	z [mm]
3/8	50	57	27	12	105	77	56	25	32	45	6	67
1/2	50	57	27	12	105	77	56	25	32	45	6	61
3/4	58	67	30	12	121	97	65	25	39	58	6	70
1	68	73	36	12	133	97	71	25	39	58	6	76
1 1/4	84	90	44	15	154	128	85	45	54	74	8	90
1 1/2	97	97	51	15	164	128	89	45	54	74	8	94
2	124	116	64	15	183	152	101	45	66	87	8	107
2 1/2	166	149	85	15	233	270	136	70	64	206	8	144
3	200	161	105	15	254	270	141	70	64	206	8	151
4	238	178	123	22	301	320	164	120	64	256	12	174



DN10/15 - 50



Ball valve type 546 PVC-U
With lockable handle
With solvent cement sockets Inch ASTM
Inclusive 2 threaded valve ends NPT

Model:

- For easy installation and removal
- z-dimension, valve end and union nut are **not compatible** with type 346 (DN10/15-50) resp. type 370 (DN65-100)
- Ball seals PTFE
- Lockable hand lever with ratchet settings
- Integrated stainless steel mounting inserts
- Threaded valve ends are only enclosed for DN10/15-50

Option:

- Individual configuration of the valve (see diagram)
- Multifunctional module with integrated limit switches
- Pneumatic or electric actuators from +GF+

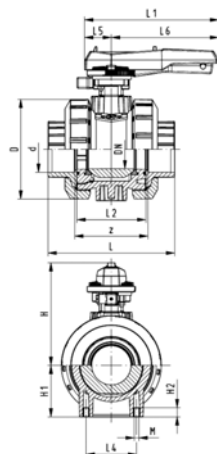
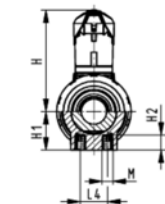
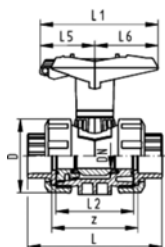

Inch	DN [mm]	PN	kv-value (Δp=1 bar) [l/min]	EPDM Code	FPM Code	kg
3/8	10	16	71	161 546 361	161 546 371	0.195
1/2	15	16	185	161 546 362	161 546 372	0.205
3/4	20	16	350	161 546 363	161 546 373	0.268
1	25	16	700	161 546 364	161 546 374	0.450
1 1/4	32	16	1000	161 546 365	161 546 375	0.770
1 1/2	40	16	1600	161 546 366	161 546 376	1.030
2	50	16	3100	161 546 367	161 546 377	1.820
2 1/2	65	16	5000	161 546 368	161 546 378	5.300
3	80	16	7000	161 546 369	161 546 379	7.700
4	100	16	11000	161 546 370	161 546 380	11.900

Inch	D [mm]	H [mm]	H1 [mm]	H2 [mm]	L [mm]	L1 [mm]	L2 [mm]	L4 [mm]	L5 [mm]	L6 [mm]	M	z [mm]
3/8	50	79	27	12	105	87	56	25	42	45	M6	67
1/2	50	79	27	12	105	87	56	25	42	45	M6	61
3/4	58	88	30	12	121	108	65	25	50	58	M6	70
1	68	94	36	12	133	108	71	25	50	58	M6	76
1 1/4	84	113	44	15	154	140	85	45	66	74	M8	90
1 1/2	97	119	51	15	164	140	89	45	66	74	M8	94
2	124	141	64	15	183	165	101	45	78	87	M8	107
2 1/2	166	224	85	15	233	270	136	70	64	206	M8	144
3	200	235	105	15	254	270	141	70	64	206	M8	151
4	238	245	123	22	301	320	164	120	64	256	M12	174



DN10/15 - 50



Ball valve type 546 PVC-U
With solvent cement sockets Inch ASTM
Inclusive 2 threaded valve ends NPT

Model:

- For easy installation and removal
- z-dimension, valve end and union nut are **not compatible** with type 346 (DN10/15-50) resp. type 370 (DN65-100)
- Ball seals PTFE
- Without mounting inserts
- Threaded valve ends are only enclosed for DN10/15-50

Option:

- Individual configuration of the valve (see diagram)
- Multifunctional module with integrated limit switches
- Pneumatic or electric actuators from +GF+

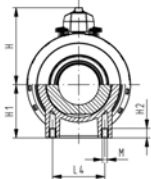
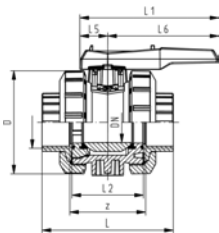
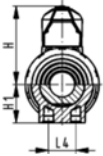
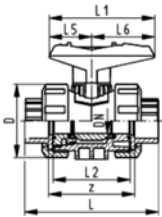

Inch	DN [mm]	PN	kv-value ($\Delta p=1$ bar) [l/min]	EPDM Code	FPM Code	kg
3/8	10	16	71	161 546 301	161 546 311	0.180
1/2	15	16	185	161 546 302	161 546 312	0.226
3/4	20	16	350	161 546 303	161 546 313	0.243
1	25	16	700	161 546 304	161 546 314	0.425
1 1/4	32	16	1000	161 546 305	161 546 315	0.730
1 1/2	40	16	1600	161 546 306	161 546 316	0.990
2	50	16	3100	161 546 307	161 546 317	1.929
2 1/2	65	16	5000	161 546 308	161 546 318	4.900
3	80	16	7000	161 546 309	161 546 319	7.400
4	100	16	11000	161 546 310	161 546 320	11.500

Inch	D [mm]	H [mm]	H1 [mm]	L [mm]	L1 [mm]	L2 [mm]	L4 [mm]	L5 [mm]	L6 [mm]	z [mm]
3/8	50	57	27	105	77	56	25	32	45	67
1/2	50	57	27	105	77	56	25	32	45	61
3/4	58	67	30	121	97	65	25	39	58	70
1	68	73	36	133	97	71	25	39	58	76
1 1/4	84	90	44	154	128	85	45	54	74	90
1 1/2	97	97	51	164	128	89	45	54	74	94
2	124	116	64	183	152	101	45	66	87	107
2 1/2	166	149	85	233	270	136	70	64	206	144
3	200	161	105	254	270	141	70	64	206	151
4	238	178	123	301	320	164	120	64	256	174

Spare Parts Ball Valve Type 546

Spare parts ball valve type 546

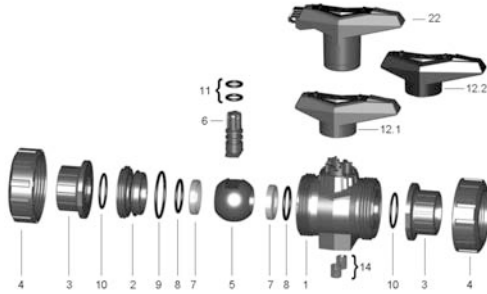

Lever



d [mm]	Inch	DN [mm]	Standard lever red Code	Standard lever black Code	Multifunctional lever Code	kg
16	3/8	10	167 484 088	167 484 076	167 484 100	0.026
20	1/2	15	167 484 088	167 484 076	167 484 100	0.026
25	3/4	20	167 484 089	167 484 077	167 484 101	0.045
32	1	25	167 484 090	167 484 078	167 484 102	0.047
40	1 1/4	32	167 484 091	167 484 079	167 484 103	0.091
50	1 1/2	40	167 484 092	167 484 080	167 484 104	0.080
63	2	50	167 484 093	167 484 081	167 484 105	0.124
75	2 1/2	65	167 484 094	167 484 082	161 486 689	0.468
90	3	80	167 484 095	167 484 083	161 486 690	0.467
110	4	100	167 484 096	167 484 084	161 486 691	0.543

Handle extension for ball valve type 546 PVC-U DN65 - DN100

Model:

- Multiple use in succession possible
- Height variable

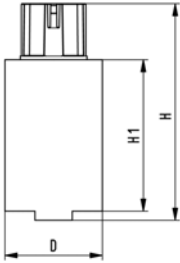

d-d [mm]	DN-DN [mm]	Code	kg	D [mm]	H [mm]	H1 [mm]
75 - 90	65 - 80	161 490 920	0.323	58	143	100
- 110	- 100	161 490 921	0.413	64	143	100

Mounting plate 546 and 543 PP-GF (L02)

- 2 mounting screws inclusive

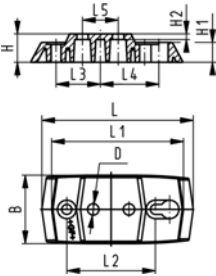

d-d [mm]	Inch [inch]	DN-DN [mm]	Code	kg
16 - 32	3/8 - 1	10 - 25	167 484 110	0.054
40 - 63	1 1/4 - 2	32 - 50	167 484 111	0.066

d-d [mm]	B [mm]	D [mm]	H [mm]	H1 [mm]	H2 [mm]	L [mm]	L1 [mm]	L2 [mm]	L3 [mm]	L4 [mm]	L5 [mm]
16 - 32	48	8	20	14	4	106	92	62	31	41	25
40 - 63	54	9	20	14	4	149	134	104	52	62	45



DN10/15 - 50

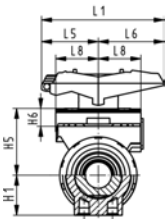
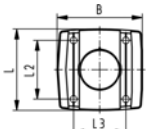

Multifunctional module (I02) PP-GF Module empty

Model:

- Accessory to Ball Valve Type 546
- Multifunctional module acts as an intermediate element for actuators
- For operation with handle, multifunctional handle has to be ordered separately.
- Including screws to mount the module and stainless steel coupling piece (V2A) for dimension DN65-100
- The multifunctional module from d75 - d110 has a master gauge F07 according to EN ISO 5211.

d-d [mm]	Inch [inch]	DN-DN [mm]	Code	kg
16 - 20	3/8 - 1/2	10 - 15	167 482 680	0.069
25 - 32	3/4 - 1	20 - 25	167 482 681	0.149
40 - 50	1 1/4 - 1 1/2	32 - 40	167 482 682	0.168
- 63	2	- 50	167 482 683	0.209
75 - 90	2 1/2 - 3	65 - 80	167 482 684	0.379
- 110	4	- 100	167 482 685	0.607

d-d [mm]	B [mm]	H1 [mm]	H5 [mm]	H6 [mm]	L [mm]	L1 [mm]	L2 [mm]	L3 [mm]	L5 [mm]	L6 [mm]	L8 [mm]
16 - 20	67	27	50	17	72	87	54	40	42	45	34
25 - 32	75	30	53	16	72	108	52	46	50	58	38
40 - 50	81	44	72	16	80	140	60	50	66	75	41
- 63	91	64	94	19	93	165	68	65	78	87	46
75 - 90	90	85	157	23	85	270			64	206	
- 110	106	123	175	23	97	320			64	256	



DN10/15 - 50

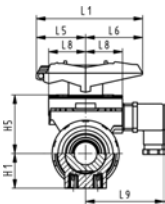

Multifunctional module (I03) PP-GF With mechanical limit switches Ag Ni

Model:

- Accessory to Ball Valve Type 546
- Multifunctional module acts as an intermediate element for actuators
- For operation with handle, multifunctional handle has to be ordered separately.
- Including Plug 3P+E / Protection: IP65
- Including screws to mount the module and stainless steel coupling piece (V2A) for dimension DN65-100

d-d [mm]	Inch [inch]	DN-DN [mm]	Code	kg
16 - 20	3/8 - 1/2	10 - 15	167 482 626	0.104
25 - 32	3/4 - 1	20 - 25	167 482 627	0.118
40 - 50	1 1/4 - 1 1/2	32 - 40	167 482 628	0.140
- 63	2	- 50	167 482 629	0.257
75 - 90	2 1/2 - 3	65 - 80	167 482 630	0.478
- 110	4	- 100	167 482 631	0.480

d-d [mm]	H1 [mm]	H5 [mm]	L1 [mm]	L5 [mm]	L6 [mm]	L8 [mm]	L9 [mm]
16 - 20	27	50	87	42	45	34	73
25 - 32	30	53	108	50	58	38	77
40 - 50	44	72	140	66	75	41	80

table continued next page

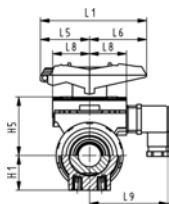

d-d [mm]	H1 [mm]	H5 [mm]	L1 [mm]	L5 [mm]	L6 [mm]	L8 [mm]	L9 [mm]
- 63	64	94	165	78	87	46	85
75 - 90	85	157	270	64	206		
- 110	123	175	320	64	256		



DN10/15 - 50



Multifunctional module (104) PP-GF With mechanical limit switches Au

Model:

- Accessory to Ball Valve Type 546
- Multifunctional module acts as an intermediate element for actuators
- For operation with handle, multifunctional handle has to be ordered separately.
- Including Plug 3P+E / Protection: IP65
- Including screws to mount the module and stainless steel coupling piece (V2A) for dimension DN65-100

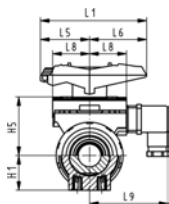

d-d [mm]	Inch [inch]	DN-DN [mm]	Code	kg
16 - 20	3/8 - 1/2	10 - 15	167 482 635	0.103
25 - 32	3/4 - 1	20 - 25	167 482 636	0.120
40 - 50	1 1/4 - 1 1/2	32 - 40	167 482 637	0.138
- 63	2	- 50	167 482 638	0.175
75 - 90	2 1/2 - 3	65 - 80	167 482 639	0.460
- 110	4	- 100	167 482 640	0.480

d-d [mm]	H1 [mm]	H5 [mm]	L1 [mm]	L5 [mm]	L6 [mm]	L8 [mm]	L9 [mm]
16 - 20	27	50	87	42	45	34	73
25 - 32	30	53	108	50	58	38	77
40 - 50	44	72	140	66	75	41	80
- 63	64	94	165	78	87	46	85
75 - 90	85	157	270	64	206		
- 110	123	175	320	64	256		



DN10/15 - 50

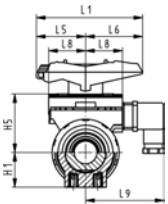

Multifunctional module (I05) PP-GF With inductive limit switches Namur

Model:

- Accessory to Ball Valve Type 546
- Multifunctional module acts as an intermediate element for actuators
- For operation with handle, multifunctional handle has to be ordered separately.
- Including Plug 3P+E / Protection: IP65
- Including screws to mount the module and stainless steel coupling piece (V2A) for dimension DN65-100

d-d [mm]	Inch [inch]	DN-DN [mm]	Code	kg
16 - 20	3/8 - 1/2	10 - 15	167 482 671	0.097
25 - 32	3/4 - 1	20 - 25	167 482 672	0.107
40 - 50	1 1/4 - 1 1/2	32 - 40	167 482 673	0.135
- 63	2	- 50	167 482 674	0.257
75 - 90	2 1/2 - 3	65 - 80	167 482 675	0.460
- 110	4	- 100	167 482 676	0.480

d-d [mm]	H1 [mm]	H5 [mm]	L1 [mm]	L5 [mm]	L6 [mm]	L8 [mm]	L9 [mm]
16 - 20	27	50	87	42	45	34	73
25 - 32	30	53	108	50	58	38	77
40 - 50	44	72	140	66	75	41	80
- 63	64	94	165	78	87	46	85
75 - 90	85	157	270	64	206		
- 110	123	175	320	64	256		



DN10/15 - 50

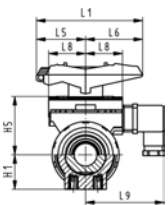

Multifunctional module (I06) PP-GF With inductive limit switches PNP

Model:

- Accessory to Ball Valve Type 546
- Multifunctional module acts as an intermediate element for actuators
- For operation with handle, multifunctional handle has to be ordered separately.
- Including Plug 3P+E / Protection: IP65
- Including screws to mount the module and stainless steel coupling piece (V2A) for dimension DN65-100

d-d [mm]	Inch [inch]	DN-DN [mm]	Code	kg
16 - 20	3/8 - 1/2	10 - 15	167 482 662	0.182
25 - 32	3/4 - 1	20 - 25	167 482 663	0.197
40 - 50	1 1/4 - 1 1/2	32 - 40	167 482 664	0.215
- 63	2	- 50	167 482 665	0.175
75 - 90	2 1/2 - 3	65 - 80	167 482 666	0.460
- 110	4	- 100	167 482 667	0.480

d-d [mm]	H1 [mm]	H5 [mm]	L1 [mm]	L5 [mm]	L6 [mm]	L8 [mm]	L9 [mm]
16 - 20	27	50	87	42	45	34	73
25 - 32	30	53	108	50	58	38	77
40 - 50	44	72	140	66	75	41	80

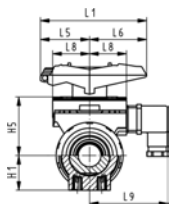

d-d [mm]	H1 [mm]	H5 [mm]	L1 [mm]	L5 [mm]	L6 [mm]	L8 [mm]	L9 [mm]
- 63	64	94	165	78	87	46	85
75 - 90	85	157	270	64	206		
- 110	123	175	320	64	256		



DN10/15 - 50



Multifunctional module (107) PP-GF With inductive limit switches NPN

Model:

- Accessory to Ball Valve Type 546
- Multifunctional module acts as an intermediate element for actuators
- For operation with handle, multifunctional handle has to be ordered separately.
- Including Plug 3P+E / Protection: IP65
- Including screws to mount the module and stainless steel coupling piece (V2A) for dimension DN65-100

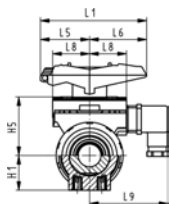

d-d [mm]	Inch [inch]	DN-DN [mm]	Code	kg
16 - 20	3/8 - 1/2	10 - 15	167 482 653	0.110
25 - 32	3/4 - 1	20 - 25	167 482 654	0.120
40 - 50	1 1/4 - 1 1/2	32 - 40	167 482 655	0.135
- 63	2	- 50	167 482 656	0.175
75 - 90	2 1/2 - 3	65 - 80	167 482 657	0.460
- 110	4	- 100	167 482 658	0.480

d-d [mm]	H1 [mm]	H5 [mm]	L1 [mm]	L5 [mm]	L6 [mm]	L8 [mm]	L9 [mm]
16 - 20	27	50	87	42	45	34	73
25 - 32	30	53	108	50	58	38	77
40 - 50	44	72	140	66	75	41	80
- 63	64	94	165	78	87	46	85
75 - 90	85	157	270	64	206		
- 110	123	175	320	64	256		

Ball Valves 375

Ball valve type 375 PVC-U With solvent cement sockets Inch BS



Model:

- For easy installation and removal
- z-dimension, valve end and union nut are not compatible with type 546
- Ball seals PTFE
- Actuator unit not connectable

Range of use:

- Basic applications of the water treatment sector as well as other applications involving water.

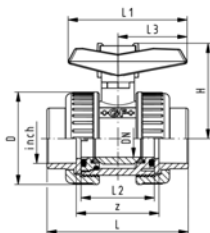

Inch	DN [mm]	PN	kv-value ($\Delta p=1$ bar) [l/min]	EPDM Code	FPM Code	kg
3/8	10	16	71	161 375 601	161 375 611	0.130
1/2	15	16	185	161 375 602	161 375 612	0.130
3/4	20	16	350	161 375 603	161 375 613	0.210
1	25	16	700	161 375 604	161 375 614	0.297
1 1/4	32	16	1000	161 375 605	161 375 615	0.450
1 1/2	40	16	1600	161 375 606	161 375 616	0.695
2	50	16	3100	161 375 607	161 375 617	1.200
	65	10	5000	161 375 508	161 375 518	2.216
3	80	10	7000	161 375 609	161 375 619	3.360
4	100	10	11000	161 375 610	161 375 620	6.060

Inch	D [mm]	H [mm]	L [mm]	L1 [mm]	L2 [mm]	L3 [mm]	z [mm]
3/8	50	53	76	67	42	40	48
1/2	50	53	80	67	42	40	48
3/4	59	60	91	77	48	45	53
1	68	67	102	87	54	51	58
1 1/4	80	79	120	102	62	59	68
1 1/2	94	90	140	119	72	70	78
2	115	107	169	146	86	84	93
	145	129	206	179	110	103	118
3	168	143	242	209	128	120	140
4	210	169	282	250	150	141	160



Ball valve type 375 PVC-U With solvent cement sockets metric

Model:

- For easy installation and removal
- z-dimension, valve end and union nut are not compatible with type 546
- Ball seals PTFE
- Actuator unit not connectable

Range of use:

- Basic applications of the water treatment sector as well as other applications involving water.

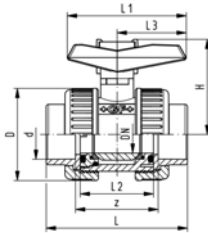

d [mm]	DN [mm]	PN	kv-value ($\Delta p=1$ bar) [l/min]	EPDM Code	FPM Code	kg	
16	10	16	71	161 375 501	161 375 511	0.130	
20	15	16	185	161 375 502	161 375 512	0.134	
25	20	16	350	161 375 503	161 375 513	0.210	
32	25	16	700	161 375 504	161 375 514	0.300	
40	32	16	1000	161 375 505	161 375 515	0.453	
50	40	16	1600	161 375 506	161 375 516	0.699	
63	50	16	3100	161 375 507	161 375 517	1.203	
75	65	10	5000	161 375 508	161 375 518	2.216	
90	80	10	7000	161 375 509	161 375 519	3.364	
110	100	10	11000	161 375 510	161 375 520	6.060	

d [mm]	D [mm]	H [mm]	L [mm]	L1 [mm]	L2 [mm]	L3 [mm]	z [mm]
16	50	53	76	67	42	40	48
20	50	53	80	67	42	40	48
25	59	60	91	77	48	45	53
32	68	67	102	87	54	51	58
40	80	79	120	102	62	59	68
50	94	90	140	119	72	70	78
63	115	107	169	146	86	84	93
75	145	129	206	179	110	103	118
90	168	143	242	209	128	120	140
110	210	169	282	250	150	141	160



Ball valve type 375 PVC-U With threaded sockets Rp

Model:

- For easy installation and removal
- z-dimension, valve end and union nut are not compatible with type 546
- Ball seals PTFE
- Actuator unit not connectable

Range of use:

- Basic applications of the water treatment sector as well as other applications involving water.

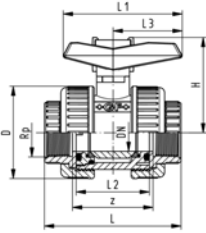

Rp [inch]	DN [mm]	PN	kv-value ($\Delta p=1$ bar) [l/min]	EPDM Code	FPM Code	kg	
3/8	10	10	71	161 375 521	161 375 531	0.130	
1/2	15	10	185	161 375 522	161 375 532	0.130	
3/4	20	10	350	161 375 523	161 375 533	0.210	
1	25	10	700	161 375 524	161 375 534	0.304	
1 1/4	32	10	1000	161 375 525	161 375 535	0.445	
1 1/2	40	10	1600	161 375 526	161 375 536	0.695	
2	50	10	3100	161 375 527	161 375 537	1.196	
2 1/2	65	10	5000	161 375 528	161 375 538	2.186	
3	80	10	7000	161 375 529	161 375 539	3.300	
4	100	10	11000	161 375 530	161 375 540	5.890	

Rp [inch]	D [mm]	H [mm]	L [mm]	L1 [mm]	L2 [mm]	L3 [mm]	z [mm]	
3/8	50	53	76	67	42	40	48	
1/2	50	53	80	67	42	40	48	
3/4	59	60	91	77	48	45	53	
1	68	67	102	87	54	51	58	
1 1/4	80	79	116	102	62	59	68	
1 1/2	94	90	126	119	72	70	78	
2	115	107	149	146	86	84	93	
2 1/2	145	129	184	179	110	103	118	
3	168	143	212	209	128	120	140	
4	210	169	244	250	150	141	160	

Ball Valve Coloro

Ball valve coloro type 353 PVC-U With solvent cement sockets ASTM/BS

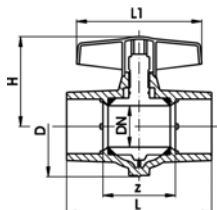

Model:

- Lever blue
- Compact
- Ball seal HD-PE / lubricant compound
- Monobloc structure
- Actuator unit not connectable
- Only bulk pack GP are delivered

Inch	DN [mm]	PN	EPDM Code	kg	z [mm]	D [mm]	L [mm]	L1 [mm]	H [mm]
½	15	16	161 353 302	0.069	33	49	78	78	51
¾	20	16	161 353 303	0.097	38	54	89	92	58
1	25	16	161 353 304	0.146	48	64	105	92	63
1 ¼	32	16	161 353 305	0.222	56	78	120	116	77
1 ½	40	16	161 353 306	0.370	66	90	137	116	83
2	50	16	161 353 307	0.707	83	112	162	140	102

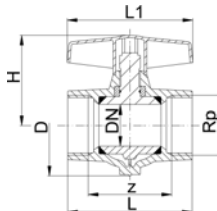

Ball valve coloro type 353 PVC-U With threaded sockets Rp

Model:

- Lever blue
- Compact
- Ball seal HD-PE / lubricant compound
- Monobloc structure
- Actuator unit not connectable
- Only bulk pack GP are delivered

Rp [inch]	DN [mm]	PN	EPDM Code	kg	z [mm]	D [mm]	L [mm]	L1 [mm]	H [mm]
½	15	10	161 353 022	0.073	40	49	70	78	51
¾	20	10	161 353 023	0.101	45	54	78	92	58
1	25	10	161 353 024	0.145	57	64	95	92	63
1 ¼	32	10	161 353 025	0.251	66	78	109	116	77
1 ½	40	10	161 353 026	0.363	74	90	118	116	83
2	50	10	161 353 027	0.693	93	112	146	140	102



Ball valve coloro type 353 PVC-U With solvent cement sockets metric

Model:

- Lever blue
- Compact
- Ball seal HD-PE / lubricant compound
- Monobloc structure
- Actuator unit not connectable
- Only bulk pack GP are delivered

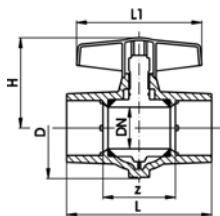

d [mm]	DN [mm]	PN	EPDM Code	kg	z [mm]	D [mm]	L [mm]	L1 [mm]	H [mm]
20	15	16	161 353 002	0.070	37	49	70	78	51
25	20	16	161 353 003	0.110	43	54	81	92	58
32	25	16	161 353 004	0.145	52	64	96	92	63
40	32	16	161 353 005	0.256	61	78	113	116	77
50	40	16	161 353 006	0.359	71	90	134	116	83
63	50	16	161 353 007	0.686	89	112	166	140	102



Ball valve coloro type 354 PVC-U With solvent cement sockets ASTM

Model:

- Lever blue
- Ball seal HD-PE / lubricant compound
- Monobloc structure
- Actuator unit not connectable
- Only bulk pack GP are delivered

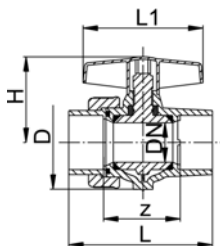

Inch	DN [mm]	PN	EPDM Code	kg	z [mm]	D [mm]	L [mm]	L1 [mm]	H [mm]
1/2	15	16	161 354 302	0.099	46	49	87	78	51
3/4	20	16	161 354 303	0.142	52	54	103	92	58
1	25	16	161 354 304	0.198	58	64	111	92	63
1 1/4	32	16	161 354 305	0.337	68	78	128	116	77
1 1/2	40	16	161 354 306	0.479	76	90	141	116	83
2	50	16	161 354 307	0.863	90	112	165	140	102



Ball valve coloro type 354 PVC-U With threaded sockets Rp

Model:

- Lever blue
- Ball seal HD-PE / lubricant compound
- Monobloc structure
- Actuator unit not connectable
- Only bulk pack GP are delivered

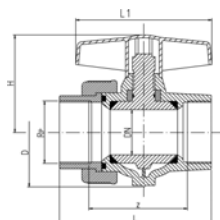

Rp [inch]	DN [mm]	PN	EPDM Code	kg	z [mm]	D [mm]	L [mm]	L1 [mm]	H [mm]
1/2	15	10	161 354 022	0.102	53	49	81	78	51
3/4	20	10	161 354 023	0.144	59	54	91	92	58
1	25	10	161 354 024	0.196	68	64	104	92	63
1 1/4	32	10	161 354 025	0.337	80	78	120	116	77
1 1/2	40	10	161 354 026	0.488	92	90	132	116	83
2	50	10	161 354 027	0.884	110	112	159	140	102



Ball valve coloro type 354 PVC-U With solvent cement sockets metric

Model:

- Lever blue
- Ball seal HD-PE / lubricant compound
- Monobloc structure
- Actuator unit not connectable
- Only bulk pack GP are delivered

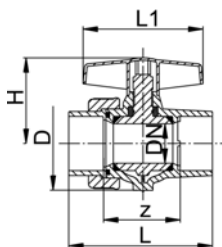

d [mm]	DN [mm]	PN	EPDM Code	kg	z [mm]	D [mm]	L [mm]	L1 [mm]	H [mm]
20	15	16	161 354 002	0.099	49	49	81	78	51
25	20	16	161 354 003	0.140	54	54	92	92	58
32	25	16	161 354 004	0.194	60	64	104	92	63
40	32	16	161 354 005	0.343	70	78	122	116	77
50	40	16	161 354 006	0.466	78	90	140	116	83
63	50	16	161 354 007	0.837	93	112	169	140	102



Ball valve coloro type 355 PVC-U With solvent cement sockets BS

Model:

- Lever blue
- Ball seal HD-PE / lubricant compound
- Monobloc structure
- Actuator unit not connectable
- Only bulk pack GP are delivered

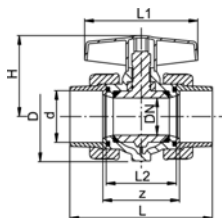

Inch	DN [mm]	PN	EPDM Code	kg	z [mm]	D [mm]	L [mm]	L1 [mm]	H [mm]	L2 [mm]
½	15	16	161 355 202	0.128	60	49	92	78	51	54
¾	20	16	161 355 203	0.102	66	54	104	92	58	60
1	25	16	161 355 204	0.240	69	64	113	92	63	63
1 ¼	32	16	161 355 205	0.414	80	78	132	116	77	74
1 ½	40	16	161 355 206	0.584	85	90	147	116	83	79
2	50	16	161 355 207	1.019	97	112	175	140	102	91



Ball valve coloro type 355 PVC-U With solvent cement sockets metric

Model:

- Lever blue
- Ball seal HD-PE / lubricant compound
- Monobloc structure
- Actuator unit not connectable
- Only bulk pack GP are delivered

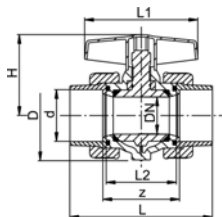

d [mm]	DN [mm]	PN	EPDM Code	kg	z [mm]	D [mm]	L [mm]	L1 [mm]	L2 [mm]	H [mm]
20	15	16	161 355 002	0.128	60	49	92	78	54	51
25	20	16	161 355 003	0.182	66	54	104	92	60	58
32	25	16	161 355 004	0.242	69	64	113	92	63	63
40	32	16	161 355 005	0.429	80	78	132	116	74	77
50	40	16	161 355 006	0.576	85	90	147	116	79	83
63	50	16	161 355 007	1.001	97	112	175	140	91	102



Ball valve coloro type 355 PVC-U With threaded sockets Rp

Model:

- Lever blue
- Ball seal HD-PE / lubricant compound
- Monobloc structure
- Actuator unit not connectable
- Only bulk pack GP are delivered

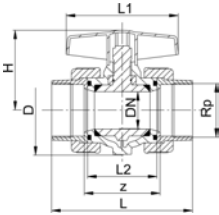

Rp [inch]	DN [mm]	PN	EPDM Code	kg	z [mm]	D [mm]	L [mm]	L1 [mm]	L2 [mm]	H [mm]
1/2	15	10	161 355 022	0.129	66	49	92	78	54	51
3/4	20	10	161 355 023	0.183	74	54	104	92	60	58
1	25	10	161 355 024	0.243	79	64	113	92	63	63
1 1/4	32	10	161 355 025	0.431	94	78	132	116	74	77
1 1/2	40	10	161 355 026	0.610	109	90	147	116	79	83
2	50	10	161 355 027	1.068	127	112	175	140	91	102



Ball valve coloro type 355 PVC-U With butt fusion spigots long PE100 For butt and electro fusion SDR11 metric

Model:

- Lever blue
- Ball seal HD-PE / lubricant compound
- Monobloc structure
- Actuator unit not connectable
- Only bulk pack GP are delivered

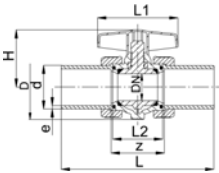

d [mm]	DN [mm]	PN	EPDM Code	kg	D [mm]	L [mm]	L1 [mm]	L2 [mm]	H [mm]	e [mm]
20	15	16	161 355 522	0.134	49	161	78	54	51	1.9
25	20	16	161 355 523	0.186	54	174	92	60	58	2.3
32	25	16	161 355 524	0.272	64	182	92	63	63	2.9
40	32	16	161 355 525	0.462	78	199	116	74	77	3.7
50	40	16	161 355 526	0.637	90	210	116	79	83	4.6
63	50	16	161 355 527	1.102	112	228	140	91	102	5.8

Ball Valves 543

3-Way ball valve type 543 PVC-U Vertical/L-port With solvent cement sockets metric

Model:

- Vertical inlet solvent cement spigot metric
- Easy installation and removal using union on third outlet
- Ball seals PTFE
- Electric actuator available separately
- Angle of operation 360° without turn limiter
- Delivery status B-C opened, see flow scheme

Mode of action:

- For interconnection of two inputs

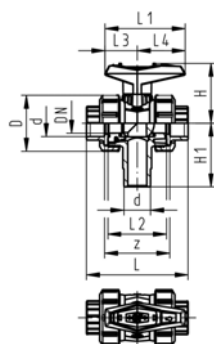
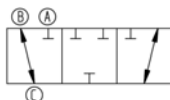
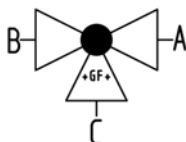

d [mm]	DN [mm]	PN	kv-value ($\Delta p=1$ bar) [l/min]	EPDM Code	FPM Code	kg
16	10	10	49	161 543 401	161 543 411	0.162
20	15	10	77	161 543 402	161 543 412	0.166
25	20	10	146	161 543 403	161 543 413	0.255
32	25	10	260	161 543 404	161 543 414	0.372
40	32	10	437	161 543 405	161 543 415	0.622
50	40	10	667	161 543 406	161 543 416	0.886
63	50	10	1293	161 543 407	161 543 417	1.617

d [mm]	D [mm]	L [mm]	L1 [mm]	L2 [mm]	L3 [mm]	L4 [mm]	H [mm]	H1 [mm]	z [mm]
16	50	92	77	56	32	45	57	62	64
20	50	95	77	56	32	45	57	62	64
25	58	111	97	66	39	58	67	72	74
32	68	123	97	71	39	58	73	77	79
40	84	146	128	85	54	74	90	87	95
50	97	157	128	89	54	74	97	97	95
63	124	183	152	101	66	87	116	112	107



3-Way ball valve type 543 PVC-U Vertical/L-port With threaded sockets Rp

Model:

- Vertical inlet solvent cement spigot metric
- Easy installation and removal using union on third outlet
- Ball seals PTFE
- Electric actuator available separately
- Angle of operation 360° without turn limiter
- Delivery status B-C opened, see flow scheme

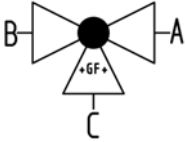

Mode of action:

- For interconnection of two inputs

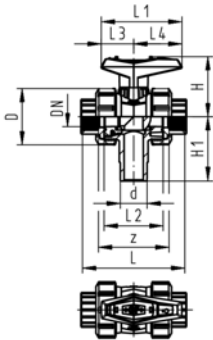
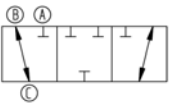

Rp [inch]	DN [mm]	PN	kv-value ($\Delta p=1$ bar) [l/min]	EPDM Code	FPM Code	kg
3/8	10	10	49	161 543 421	161 543 431	0.162
1/2	15	10	77	161 543 422	161 543 432	0.166
3/4	20	10	146	161 543 423	161 543 433	0.255
1	25	10	260	161 543 424	161 543 434	0.372
1 1/4	32	10	437	161 543 425	161 543 435	0.622
1 1/2	40	10	667	161 543 426	161 543 436	0.886
2	50	10	1293	161 543 427	161 543 437	1.617

Rp [inch]	D [mm]	L [mm]	L1 [mm]	L2 [mm]	L3 [mm]	L4 [mm]	H [mm]	H1 [mm]	z [mm]
3/8	50	96	77	56	32	45	57	62	69
1/2	50	99	77	56	32	45	57	62	67
3/4	58	115	97	66	39	58	67	72	78
1	68	127	97	71	39	58	73	77	85
1 1/4	84	144	128	85	54	74	90	87	100
1 1/2	97	153	128	89	54	74	97	97	106
2	124	177	152	101	66	87	116	112	121



3-Way ball valve type 543 PVC-U Vertical/L-port With solvent cement spigots metric

Model:

- Vertical inlet solvent cement spigot metric
- Easy installation and removal using union on third outlet
- Ball seals PTFE
- Electric actuator available separately
- Angle of operation 360° without turn limiter
- Delivery status B-C opened, see flow scheme

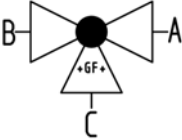

Mode of action:

- For interconnection of two inputs

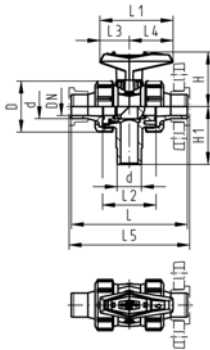
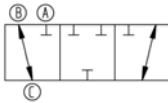

d [mm]	DN [mm]	PN	kv-value ($\Delta p=1$ bar) [l/min]	EPDM Code	FPM Code	kg
16	10	10	49	161 543 441	161 543 451	0.166
20	15	10	77	161 543 442	161 543 452	0.172
25	20	10	146	161 543 443	161 543 453	0.265
32	25	10	260	161 543 444	161 543 454	0.388
40	32	10	437	161 543 445	161 543 455	0.636
50	40	10	667	161 543 446	161 543 456	0.928
63	50	10	1293	161 543 447	161 543 457	1.701

d [mm]	D [mm]	L [mm]	L1 [mm]	L2 [mm]	L3 [mm]	L4 [mm]	L5 [mm]	H [mm]	H1 [mm]
16	50	114	77	56	32	45	120	57	62
20	50	124	77	56	32	45	130	57	62
25	58	144	97	66	39	58	150	67	72
32	68	154	97	71	39	58	160	73	77
40	84	174	128	85	54	74	180	90	87
50	97	194	128	89	54	74	200	97	97
63	124	224	152	101	66	87	230	116	112



3-Way ball valve type 543 PVC-U Vertical/L-port With solvent cement sockets BS

Model:

- Vertical inlet solvent cement spigot metric
- Easy installation and removal using union on third outlet
- Ball seals PTFE
- Electric actuator available separately
- Angle of operation 360° without turn limiter
- Delivery status B-C opened, see flow scheme

Mode of action:

- For interconnection of two inputs

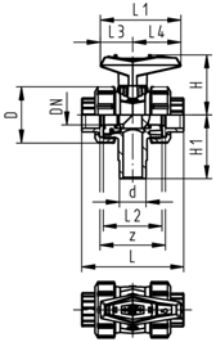
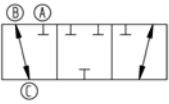
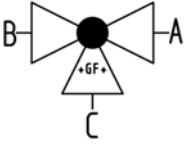

Inch	DN [mm]	PN	kv-value ($\Delta p=1$ bar) [l/min]	EPDM Code	FPM Code	kg
3/8	10	10	49	161 543 601	161 543 611	0.162
1/2	15	10	77	161 543 602	161 543 612	0.166
3/4	20	10	146	161 543 603	161 543 613	0.255
1	25	10	260	161 543 604	161 543 614	0.372
1 1/4	32	10	437	161 543 605	161 543 615	0.622
1 1/2	40	10	667	161 543 606	161 543 616	0.886
2	50	10	1293	161 543 607	161 543 617	1.617

Inch	D [mm]	L [mm]	L1 [mm]	L2 [mm]	L3 [mm]	L4 [mm]	H [mm]	H1 [mm]	z [mm]
3/8	50	92	77	56	32	45	57	62	60
1/2	50	95	77	56	32	45	57	62	60
3/4	58	111	97	66	39	58	67	72	69
1	68	123	97	71	39	58	73	77	75
1 1/4	84	146	128	85	54	74	90	87	89
1 1/2	97	157	128	89	54	74	97	97	97
2	124	183	152	101	66	87	116	112	110



3-Way ball valve type 543 PVC-U Horizontal/L-port With solvent cement sockets metric

Model:

- For easy installation and removal (valve end and union nut are compatible with type 546)
- Ball seals PTFE
- Pneumatic or electric actuator available separately
- Angle of operation 360° without turn limiter
- Turn limiter 90° enclosed, in different positions usable as a clip-on ring
- Integrated stainless steel mounting inserts
- Delivery status A-C opened, see flow scheme

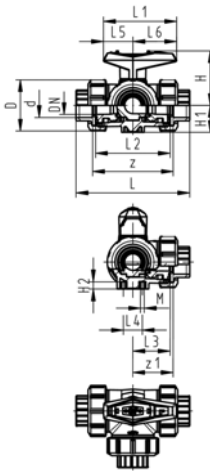
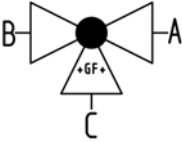

d [mm]	DN [mm]	PN	kv-value ($\Delta p=1$ bar) [l/min]	EPDM Code	FPM Code	kg
16	10	10	50	161 543 001	161 543 011	0.245
20	15	10	75	161 543 002	161 543 012	0.251
25	20	10	150	161 543 003	161 543 013	0.361
32	25	10	280	161 543 004	161 543 014	0.551
40	32	10	480	161 543 005	161 543 015	0.938
50	40	10	620	161 543 006	161 543 016	1.388
63	50	10	1230	161 543 007	161 543 017	2.705

d [mm]	D [mm]	L [mm]	L1 [mm]	L2 [mm]	L3 [mm]	L4 [mm]	L5 [mm]	L6 [mm]	H [mm]	H1 [mm]	H2 [mm]	M	z [mm]	z1 [mm]
16	50	109	77	73	36	25	32	45	57	28	8	6	81	40
20	50	112	77	73	36	25	32	45	57	28	8	6	81	40
25	58	131	97	86	43	25	39	58	67	32	8	6	94	47
32	68	151	97	99	50	25	39	58	73	36	8	6	107	54
40	84	181	128	120	60	45	54	74	90	45	9	8	130	65
50	97	205	128	137	69	45	54	74	97	51	9	8	143	72
63	124	261	152	179	89	45	66	87	116	65	9	8	185	92



3-Way ball valve type 543 PVC-U Horizontal/L-port With threaded sockets Rp

Model:

- For easy installation and removal (valve end and union nut are compatible with type 546)
- Ball seals PTFE
- Pneumatic or electric actuator available separately
- Angle of operation 360° without turn limiter
- Turn limiter 90° enclosed, in different positions usable as a clip-on ring
- Integrated stainless steel mounting inserts
- Delivery status A-C opened, see flow scheme

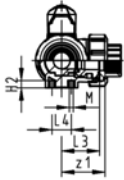
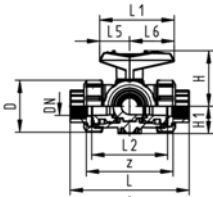
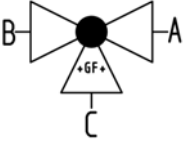

Rp [inch]	DN [mm]	PN	kv-value ($\Delta p=1$ bar) [l/min]	EPDM Code	FPM Code	kg
3/8	10	10	50	161 543 041	161 543 051	0.245
1/2	15	10	75	161 543 042	161 543 052	0.251
3/4	20	10	150	161 543 043	161 543 053	0.361
1	25	10	280	161 543 044	161 543 054	0.551
1 1/4	32	10	480	161 543 045	161 543 055	0.938
1 1/2	40	10	620	161 543 046	161 543 056	1.390
2	50	10	1230	161 543 047	161 543 057	2.705

Rp [inch]	D [mm]	L [mm]	L1 [mm]	L2 [mm]	L3 [mm]	L4 [mm]	L5 [mm]	L6 [mm]	H [mm]	H1 [mm]	H2 [mm]	M [mm]	z [mm]	z1 [mm]
3/8	50	113	77	73	36	25	32	45	57	28	8	6	87	43
1/2	50	117	77	73	36	25	32	45	57	28	8	6	85	42
3/4	58	135	97	86	43	25	39	58	67	32	8	6	100	50
1	68	155	97	99	50	25	39	58	73	36	8	6	113	57
1 1/4	84	179	128	120	60	45	54	74	90	45	9	8	134	67
1 1/2	97	201	128	137	69	45	54	74	97	51	9	8	155	78
2	124	255	152	179	89	45	66	87	116	65	9	8	199	99



3-Way ball valve type 543 PVC-U Horizontal/L-port With solvent cement sockets BS

Model:

- For easy installation and removal (valve end and union nut are compatible with type 546)
- Ball seals PTFE
- Pneumatic or electric actuator available separately
- Angle of operation 360° without turn limiter
- Turn limiter 90° enclosed, in different positions usable as a clip-on ring
- Integrated stainless steel mounting inserts
- Delivery status A-C opened, see flow scheme

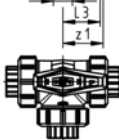
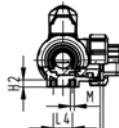
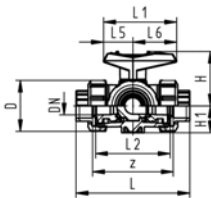
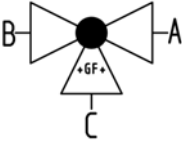

Inch	DN [mm]	PN	kv-value ($\Delta p=1$ bar) [l/min]	EPDM Code	FPM Code	kg
3/8	10	10	50	161 543 061	161 543 071	0.245
1/2	15	10	75	161 543 062	161 543 072	0.251
3/4	20	10	150	161 543 063	161 543 073	0.361
1	25	10	280	161 543 064	161 543 074	0.551
1 1/4	32	10	480	161 543 065	161 543 075	0.938
1 1/2	40	10	620	161 543 066	161 543 076	1.390
2	50	10	1230	161 543 067	161 543 077	2.705

Inch	D [mm]	L [mm]	L1 [mm]	L2 [mm]	L3 [mm]	L4 [mm]	L5 [mm]	L6 [mm]	H [mm]	H1 [mm]	H2 [mm]	M	z [mm]	z1 [mm]
3/8	50	109	77	73	36	25	32	45	57	28	8	6	77	38
1/2	50	112	77	73	36	25	32	45	57	28	8	6	77	38
3/4	58	131	97	86	43	25	39	58	67	32	8	6	90	45
1	68	151	97	99	50	25	39	58	73	36	8	6	103	52
1 1/4	84	181	128	120	60	45	54	74	90	45	9	8	124	62
1 1/2	97	205	128	137	69	45	54	74	97	51	9	8	145	73
2	124	261	152	179	89	45	66	87	116	65	9	8	189	94



3-Way ball valve type 543 PVC-U Horizontal/T-port With solvent cement sockets BS

Model:

- For easy installation and removal (valve end and union nut are compatible with type 546)
- Ball seals PTFE
- Pneumatic or electric actuator available separately
- Angle of operation 360° without turn limiter
- Turn limiter 90° enclosed, in different positions usable as a clip-on ring
- Integrated stainless steel mounting inserts
- Delivery status A-B-C opened, see flow scheme

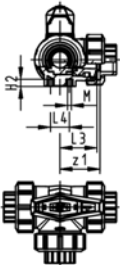
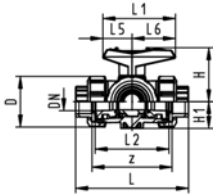
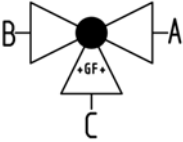

Inch	DN [mm]	PN	kv-value ($\Delta p=1$ bar) [l/min]	EPDM Code	FPM Code	kg
3/8	10	10	140	161 543 261	161 543 271	0.244
1/2	15	10	200	161 543 262	161 543 272	0.250
3/4	20	10	470	161 543 263	161 543 273	0.359
1	25	10	793	161 543 264	161 543 274	0.544
1 1/4	32	10	1290	161 543 265	161 543 275	0.927
1 1/2	40	10	1910	161 543 266	161 543 276	1.391
2	50	10	3100	161 543 267	161 543 277	2.660

Inch	D [mm]	L [mm]	L1 [mm]	L2 [mm]	L3 [mm]	L4 [mm]	L5 [mm]	L6 [mm]	H [mm]	H1 [mm]	H2 [mm]	M [mm]	z [mm]	z1 [mm]
3/8	50	109	77	73	36	25	32	45	57	28	8	6	77	38
1/2	50	112	77	73	36	25	32	45	57	28	8	6	77	38
3/4	58	131	97	86	43	25	39	58	67	32	8	6	90	45
1	68	151	97	99	50	25	39	58	73	36	8	6	103	52
1 1/4	84	181	128	120	60	45	54	74	90	45	9	8	124	62
1 1/2	97	205	128	137	69	45	54	74	97	51	9	8	145	73
2	124	261	152	179	89	45	66	87	116	65	9	8	189	94



3-Way ball valve type 543 PVC-U Horizontal/T-port With solvent cement sockets metric

Model:

- For easy installation and removal (valve end and union nut are compatible with type 546)
- Ball seals PTFE
- Pneumatic or electric actuator available separately
- Angle of operation 360° without turn limiter
- Turn limiter 90° enclosed, in different positions usable as a clip-on ring
- Integrated stainless steel mounting inserts
- Delivery status A-B-C opened, see flow scheme

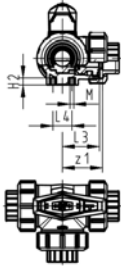
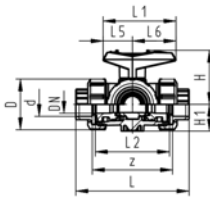
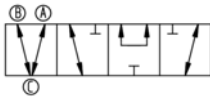
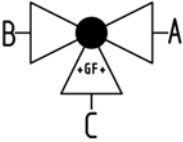

d [mm]	DN [mm]	PN	kv-value ($\Delta p=1$ bar) [l/min]	EPDM Code	FPM Code	kg
16	10	10	140	161 543 201	161 543 211	0.244
20	15	10	200	161 543 202	161 543 212	0.250
25	20	10	470	161 543 203	161 543 213	0.359
32	25	10	793	161 543 204	161 543 214	0.544
40	32	10	1290	161 543 205	161 543 215	0.927
50	40	10	1910	161 543 206	161 543 216	1.369
63	50	10	3100	161 543 207	161 543 217	2.660

d [mm]	D [mm]	L [mm]	L1 [mm]	L2 [mm]	L3 [mm]	L4 [mm]	L5 [mm]	L6 [mm]	H [mm]	H1 [mm]	H2 [mm]	M	z [mm]	z1 [mm]
16	50	109	77	73	36	25	32	45	57	28	8	6	81	40
20	50	112	77	73	36	25	32	45	57	28	8	6	81	40
25	58	131	97	86	43	25	39	58	67	32	8	6	94	47
32	68	151	97	99	50	25	39	58	73	36	8	6	107	54
40	84	181	128	120	60	45	54	74	90	45	9	8	130	65
50	97	205	128	137	69	45	54	74	97	51	9	8	143	72
63	124	261	152	179	89	45	66	87	116	65	9	8	185	92



3-Way ball valve type 543 PVC-U Horizontal/T-port With threaded sockets Rp

Model:

- For easy installation and removal (valve end and union nut are compatible with type 546)
- Ball seals PTFE
- Pneumatic or electric actuator available separately
- Angle of operation 360° without turn limiter
- Turn limiter 90° enclosed, in different positions usable as a clip-on ring
- Integrated stainless steel mounting inserts
- Delivery status A-B-C opened, see flow scheme

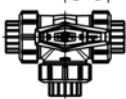
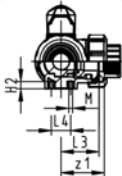
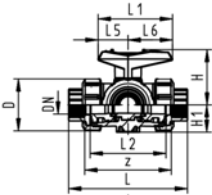
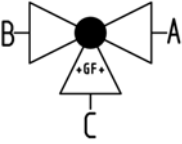

Rp [inch]	DN [mm]	PN	kv-value ($\Delta p=1$ bar) [l/min]	EPDM Code	FPM Code	kg
3/8	10	10	140	161 543 241	161 543 251	0.244
1/2	15	10	200	161 543 242	161 543 252	0.250
3/4	20	10	470	161 543 243	161 543 253	0.359
1	25	10	793	161 543 244	161 543 254	0.544
1 1/4	32	10	1290	161 543 245	161 543 255	0.927
1 1/2	40	10	1910	161 543 246	161 543 256	1.400
2	50	10	3100	161 543 247	161 543 257	2.660

Rp [inch]	D [mm]	L [mm]	L1 [mm]	L2 [mm]	L3 [mm]	L4 [mm]	L5 [mm]	L6 [mm]	H [mm]	H1 [mm]	H2 [mm]	M [mm]	z [mm]	z1 [mm]
3/8	50	113	77	73	36	25	32	45	57	28	8	6	87	43
1/2	50	117	77	73	36	25	32	45	57	28	8	6	85	42
3/4	58	135	97	86	43	25	39	58	67	32	8	6	100	50
1	68	155	97	99	50	25	39	58	73	36	8	6	113	57
1 1/4	84	179	128	120	60	45	54	74	90	45	9	8	134	67
1 1/2	97	201	128	137	69	45	54	74	97	51	9	8	155	78
2	124	255	152	179	89	45	66	87	116	65	9	8	199	99



3-Way ball valve type 543 PVC-U Horizontal/T-port With solvent cement spigots metric

Model:

- For easy installation and removal (valve end and union nut are compatible with type 546)
- Ball seals PTFE
- Pneumatic or electric actuator available separately
- Angle of operation 360° without turn limiter
- Turn limiter 90° enclosed, in different positions usable as a clip-on ring
- Integrated stainless steel mounting inserts
- Delivery status A-B-C opened, see flow scheme

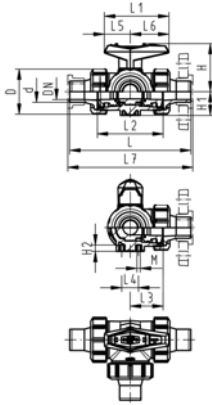
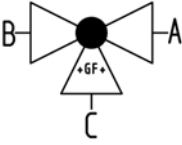

d [mm]	DN [mm]	PN	kv-value ($\Delta p=1$ bar) [l/min]	EPDM Code	FPM Code	kg
16	10	10	140	161 543 221	161 543 231	0.250
20	15	10	200	161 543 222	161 543 232	0.259
25	20	10	470	161 543 223	161 543 233	0.374
32	25	10	793	161 543 224	161 543 234	0.568
40	32	10	1290	161 543 225	161 543 235	0.948
50	40	10	1910	161 543 226	161 543 236	1.432
63	50	10	3100	161 543 227	161 543 237	2.786

d [mm]	D [mm]	L [mm]	L1 [mm]	L2 [mm]	L3 [mm]	L4 [mm]	L5 [mm]	L6 [mm]	L7 [mm]	H [mm]	H1 [mm]	H2 [mm]	M
16	50	131	77	73	36	25	32	45	137	57	28	8	6
20	50	141	77	73	36	25	32	45	147	57	28	8	6
25	58	165	97	86	43	25	39	58	171	67	32	8	6
32	68	182	97	99	50	25	39	58	188	73	36	8	6
40	84	209	128	120	60	45	54	74	215	90	45	9	8
50	97	242	128	137	69	45	54	74	248	97	51	9	8
63	124	302	152	179	89	45	66	87	308	116	65	9	8



3-Way ball valve type 543 PVC-U
Horizontal/T-port
With butt fusion spigots long
PE100 SDR11 metric

Model:

- For easy installation and removal (valve end and union nut are compatible with type 546)
- Ball seals PTFE
- Pneumatic or electric actuator available separately
- Angle of operation 360° without turn limiter
- Turn limiter 90° enclosed, in different positions usable as a clip-on ring
- Integrated stainless steel mounting inserts
- Delivery status A-B-C opened, see flow scheme

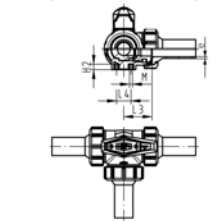
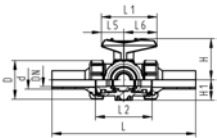
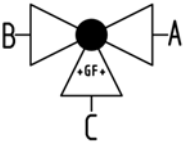

d [mm]	DN [mm]	PN	kv-value (Δp=1 bar) [l/min]	EPDM Code	FPM Code	kg
20	15	10	200	161 543 482	161 543 492	0.253
25	20	10	470	161 543 483	161 543 493	0.368
32	25	10	793	161 543 484	161 543 494	0.556
40	32	10	1290	161 543 485	161 543 495	0.942
50	40	10	1910	161 543 486	161 543 496	1.423
63	50	10	3100	161 543 487	161 543 497	3.096

d [mm]	D [mm]	L [mm]	L1 [mm]	L2 [mm]	L3 [mm]	L4 [mm]	L5 [mm]	L6 [mm]	H [mm]	H1 [mm]	H2 [mm]	M	e [mm]
20	50	210	77	73	36	25	32	45	57	28	8	6	2.3
25	58	237	97	86	43	25	39	58	67	32	8	6	2.3
32	68	251	97	99	50	25	39	58	73	36	8	6	2.9
40	84	283	128	120	60	45	54	74	90	45	9	8	3.7
50	97	319	128	137	69	45	54	74	97	51	9	8	4.6
63	124	399	152	179	89	45	66	87	116	65	9	8	5.8

Spare parts ball valve type 543 vertical

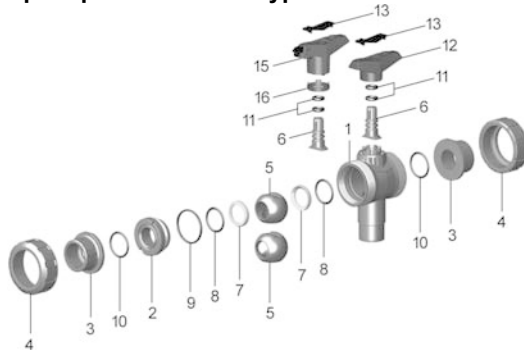



Lever

d [mm]	Inch	DN [mm]	Standard lever L- port red Code	Standard lever di- verter ball red Code	Multifunctional- lever L-port red Code	
16	3/8	10	167 484 688	167 484 788	167 484 642	
20	1/2	15	167 484 688	167 484 788	167 484 642	
25	3/4	20	167 484 689	167 484 789	167 484 643	
32	1	25	167 484 690	167 484 790	167 484 644	
40	1 1/4	32	167 484 691	167 484 791	167 484 645	
50	1 1/2	40	167 484 692	167 484 792	167 484 646	
63	2	50	167 484 693	167 484 793	167 484 647	

d [mm]	Inch	DN [mm]	Multifunctional- lever diverter ball red Code	kg	
16	3/8	10	167 484 742	0.026	
20	1/2	15	167 484 742	0.026	
25	3/4	20	167 484 743	0.045	
32	1	25	167 484 744	0.045	
40	1 1/4	32	167 484 745	0.082	
50	1 1/2	40	167 484 746	0.082	
63	2	50	167 484 747	0.104	



Assembly kit

Model:

- Intermediate element for ball valve type 543 vertical and electric or pneumatic actuators EA21; PA11/21
- Including screws and position indicator for actuators

d [mm]	Inch [inch]	DN [mm]	Code	kg	
16 - 20	3/8 - 1/2	10 - 15	167 484 945	0.170	
25 - 32	3/4 - 1	20 - 25	167 484 946	0.164	
40 - 50	1 1/4 - 1 1/2	32 - 40	167 484 947	0.203	
63	2	50	167 484 948	0.260	

Metering ball valve 323

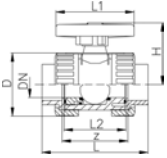

Metering ball valve type 323 PVC-U With solvent cement sockets BS Inch

Model:

- For easy installation and removal
- Ball seals PTFE
- Angle of operation 180° with scale

Inch	DN [mm]	PN	kv-value ($\Delta p=1$ bar) [l/min]	EPDM Code	FPM Code	kg
3/8	10	10	11	161 323 501	161 323 511	0.100
1/2	15	10	20	161 323 502	161 323 512	0.159

Inch	z	D	L	L1	L2	H
3/8	71	45	99	78	63	50
1/2	71	45	102	78	63	50

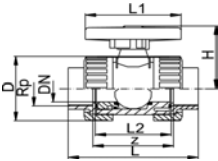

Metering ball valve type 323 PVC-U With threaded sockets Rp

Rp [inch]	DN [mm]	PN	kv-value ($\Delta p=1$ bar) [l/min]	EPDM Code	FPM Code	kg
3/8	10	10	11	161 323 421	161 323 431	0.162
1/2	15	10	20	161 323 422	161 323 432	0.161

Rp [inch]	D [mm]	L [mm]	L1 [mm]	L2 [mm]	H [mm]	z [mm]
3/8	45	99	78	63	50	67
1/2	45	102	78	63	50	67

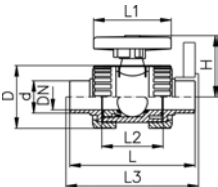

Metering ball valve type 323 PVC-U With solvent cement spigots metric

Model:

- For easy installation and removal
- Ball seals PTFE
- Angle of operation 180° with scale
- Overall length EN 558

d [mm]	DN [mm]	PN	kv-value ($\Delta p=1$ bar) [l/min]	EPDM Code	FPM Code	kg
16	10	10	11	161 323 441	161 323 451	0.162
20	15	10	20	161 323 442	161 323 452	0.160

d [mm]	D [mm]	L [mm]	L1 [mm]	L2 [mm]	L3 [mm]	H [mm]
16	45	114	78	63	120	50
20	45	124	78	63	130	50



Metering ball valve type 323 PVC-U With solvent cement sockets metric

Model:

- For easy installation and removal
- Ball seals PTFE
- Angle of operation 180° with scale

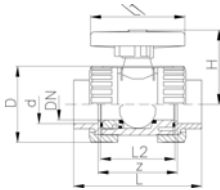

d [mm]	DN [mm]	PN	kv-value ($\Delta p=1 \text{ bar}$) [l/min]	EPDM Code	FPM Code	kg	
16	10	10	11	161 323 401	161 323 411	0.160	
20	15	10	20	161 323 402	161 323 412	0.161	

d [mm]	z [mm]	D [mm]	L [mm]	L1 [mm]	L2 [mm]	H [mm]	
16	71	45	99	78	63	50	
20	71	45	102	78	63	50	

Linear ball valves

Linear ball valve type 546 PVC-U With mounting inserts With solvent cement sockets metric

Model:

- For easy installation and removal
- z-dimension, valve end and union nut are **not compatible** with type 346 (DN10/15-50) resp. type 370 (DN65-100)
- Ball seals PTFE
- Integrated stainless steel mounting inserts
- Lockable hand lever with ratchet settings
- Linear Ball available in DN15, DN25 and DN50
- Linear Ball makes a linear flow characteristic possible
- Opening scale printed on multifunctional modul

Option:

- Individual configuration of the valve (see diagram)

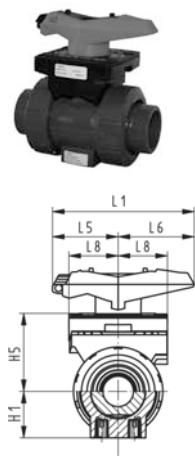

d [mm]	DN [mm]	kv-100-value ($\Delta p=1$ bar) [l/min]	EPDM Code	FPM Code	kg	
20	15	86	800 017 580	800 026 280	0.540	
32	25	220	800 015 100	800 015 101	0.460	
63	50	735	800 026 279	800 026 281	1.790	

Laboratory ball cock 322



Laboratory ball cock type 322 PVC-U With solvent cement sockets Inch BS/ASTM

Model:

- Disconnection one end only
- Ball seals PTFE
- Angle of operation 90°

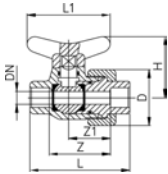

Inch	DN [mm]	PN	EPDM Code	FPM Code	kg	
1/8	6	10	161 324 150	161 324 199	0.042	
1/4	8	10	161 324 200	161 324 249	0.045	

Inch	z [mm]	z1 [mm]	D [mm]	L [mm]	L1 [mm]	H [mm]	
1/8	26	15	34	52	45	38	
1/4	36	25	34	60	45	38	



Laboratory ball cock type 322 PVC-U With solvent cement sockets metric

Model:

- Disconnection one end only
- Ball seals PTFE

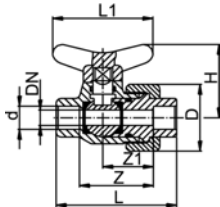

d [mm]	DN [mm]	PN	EPDM Code	FPM Code	kg	
10	6	10	161 322 150	161 322 199	0.043	
12	8	10	161 322 200	161 322 249	0.050	

d [mm]	D [mm]	L [mm]	L1 [mm]	H [mm]	z [mm]	z1 [mm]	
10	34	52	45	38	26	15	
12	34	60	45	38	36	25	

Diaphragm valves

Diaphragm valve type 514 PVC-U With solvent cement sockets BS

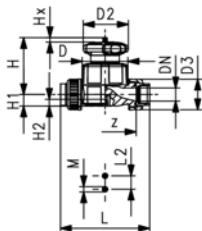

Model:

- Double flow rate compared to predecessor
- One housing nut replaces four screws
- Handwheel with built-in locking mechanism
- For easy installation and removal
- Short overall length

Option:

- Individual configuration of the valve (see diagram)
- Self adjusting multifunctional module with integrated limit switches
- PN16 available as a configuration

Inch	DN [mm]	PN	kv-value ($\Delta p=1$ bar) [l/min]	NBR Code	EPDM Code	PTFE/EPDM Code
1/2	15	10	125	161 514 502	161 514 512	161 514 532
3/4	20	10	271	161 514 503	161 514 513	161 514 533
1	25	10	481	161 514 504	161 514 514	161 514 534
1 1/4	32	10	759	161 514 505	161 514 515	161 514 535
1 1/2	40	10	1263	161 514 506	161 514 516	161 514 536
2	50	10	1728	161 514 507	161 514 517	161 514 537

Inch	DN [mm]	PN	kv-value ($\Delta p=1$ bar) [l/min]	FPM Code	kg
1/2	15	10	125	161 514 562	0.300
3/4	20	10	271	161 514 563	0.432
1	25	10	481	161 514 564	0.687
1 1/4	32	10	759	161 514 565	1.419
1 1/2	40	10	1263	161 514 566	2.528
2	50	10	1728	161 514 567	3.409

Inch	D [mm]	D2 [mm]	D3 [mm]	L [mm]	L2 [mm]	H [mm]	H1 [mm]	H2 [mm]	M	z [mm]	Lift = Hx [mm]
1/2	65	65	43	128	25	73	14	12	M6	96	7
3/4	80	65	51	152	25	81	18	12	M6	114	10
1	88	87	58	166	25	107	22	12	M6	122	13
1 1/4	101	87	72	192	45	115	26	15	M8	140	15
1 1/2	117	135	83	222	45	148	32	15	M8	160	19
2	144	135	100	266	45	166	39	15	M8	190	25



Diaphragm valve type 514 PVC-U With solvent cement sockets metric

Model:

- Double flow rate compared to predecessor
- One housing nut replaces four screws
- Handwheel with built-in locking mechanism
- For easy installation and removal
- Short overall length

Option:

- Individual configuration of the valve (see diagram)
- Self adjusting multifunctional module with integrated limit switches
- PN16 available as a configuration

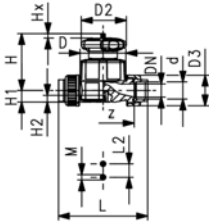

d [mm]	DN [mm]	PN	kv-value ($\Delta p=1$ bar) [l/min]	NBR Code	EPDM Code	PTFE/EPDM Code	
16	10	10	125	161 514 001	161 514 011	161 514 031	
20	15	10	125	161 514 002	161 514 012	161 514 032	
25	20	10	271	161 514 003	161 514 013	161 514 033	
32	25	10	481	161 514 004	161 514 014	161 514 034	
40	32	10	759	161 514 005	161 514 015	161 514 035	
50	40	10	1263	161 514 006	161 514 016	161 514 036	
63	50	10	1728	161 514 007	161 514 017	161 514 037	

d [mm]	DN [mm]	PN	kv-value ($\Delta p=1$ bar) [l/min]	FPM Code	kg	
16	10	10	125	161 514 061	0.310	
20	15	10	125	161 514 062	0.302	
25	20	10	271	161 514 063	0.691	
32	25	10	481	161 514 064	0.691	
40	32	10	759	161 514 065	0.982	
50	40	10	1263	161 514 066	2.516	
63	50	10	1728	161 514 067	2.546	

d [mm]	D [mm]	D2 [mm]	D3 [mm]	L [mm]	L2 [mm]	H [mm]	H1 [mm]	H2 [mm]	M	z [mm]	Lift = Hx [mm]	
16	65	65	43	170	25	73	14	12	M6	142	7	
20	65	65	43	128	25	73	14	12	M6	96	7	
25	80	65	51	152	25	81	18	12	M6	114	10	
32	88	87	58	166	25	107	22	12	M6	122	13	
40	101	87	72	192	45	115	26	15	M8	140	15	
50	117	135	83	222	45	148	32	15	M8	160	19	
63	144	135	100	266	45	166	39	15	M8	190	25	



Diaphragm valve type 514 PVC-U With threaded sockets Rp

Model:

- Double flow rate compared to predecessor
- One housing nut replaces four screws
- Handwheel with built-in locking mechanism
- For easy installation and removal
- Short overall length

Option:

- Individual configuration of the valve (see diagram)
- Self adjusting multifunctional module with integrated limit switches
- PN16 available as a configuration

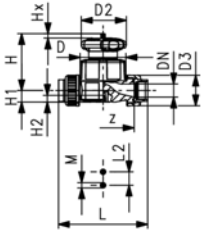

Rp [inch]	DN [mm]	PN	kv-value ($\Delta p=1$ bar) [l/min]	NBR Code	EPDM Code	PTFE/EPDM Code
1/2	15	10	125	161 514 402	161 514 412	161 514 432
3/4	20	10	271	161 514 403	161 514 413	161 514 433
1	25	10	481	161 514 404	161 514 414	161 514 434
1 1/4	32	10	759	161 514 405	161 514 415	161 514 435
1 1/2	40	10	1263	161 514 406	161 514 416	161 514 436
2	50	10	1728	161 514 407	161 514 417	161 514 437

Rp [inch]	DN [mm]	PN	kv-value ($\Delta p=1$ bar) [l/min]	FPM Code	kg
1/2	15	10	125	161 514 462	0.400
3/4	20	10	271	161 514 463	0.522
1	25	10	481	161 514 464	1.163
1 1/4	32	10	759	161 514 465	1.429
1 1/2	40	10	1263	161 514 466	2.528
2	50	10	1728	161 514 467	3.449

Rp [inch]	D [mm]	D2 [mm]	D3 [mm]	L [mm]	L2 [mm]	H [mm]	H1 [mm]	H2 [mm]	M	z [mm]	Lift = Hx [mm]
1/2	65	65	43	128	25	73	14	12	M6	96	7
3/4	80	65	51	152	25	81	18	12	M6	114	10
1	88	87	58	166	25	107	22	12	M6	122	13
1 1/4	101	87	72	192	45	115	26	15	M8	140	15
1 1/2	117	135	83	222	45	148	32	15	M8	160	19
2	144	135	100	266	45	166	39	15	M8	190	25



Diaphragm valve type 515 PVC-U With solvent cement spigots metric

Model:

- Double flow rate compared to predecessor
- One housing nut replaces four screws
- Handwheel with built-in locking mechanism
- Overall length EN 558

Option:

- Individual configuration of the valve (see diagram)
- Self adjusting multifunctional module with integrated limit switches
- PN16 available as a configuration

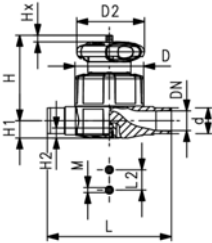

d [mm]	DN [mm]	PN	kv-value ($\Delta p=1$ bar) [l/min]	NBR Code	EPDM Code	PTFE/EPDM Code
20	15	10	125	161 515 002	161 515 012	161 515 032
25	20	10	271	161 515 003	161 515 013	161 515 033
32	25	10	481	161 515 004	161 515 014	161 515 034
40	32	10	759	161 515 005	161 515 015	161 515 035
50	40	10	1263	161 515 006	161 515 016	161 515 036
63	50	10	1728	161 515 007	161 515 017	161 515 037

d [mm]	DN [mm]	PN	kv-value ($\Delta p=1$ bar) [l/min]	FPM Code	kg
20	15	10	125	161 515 062	0.243
25	20	10	271	161 515 063	0.444
32	25	10	481	161 515 064	1.032
40	32	10	759	161 515 065	0.785
50	40	10	1263	161 515 066	2.262
63	50	10	1728	161 515 067	2.963

d [mm]	D [mm]	D2 [mm]	L [mm]	L2 [mm]	H [mm]	H1 [mm]	H2 [mm]	M	Lift = Hx [mm]
20	65	65	124	25	73	14	12	M6	7
25	80	65	144	25	81	18	12	M6	10
32	88	87	154	25	107	22	12	M6	13
40	101	87	174	45	115	26	15	M8	15
50	117	135	194	45	148	32	15	M8	19
63	144	135	224	45	166	39	15	M8	25



Diaphragm valve type 517 PVC-U With backing flanges PVC-U metric/BS

Model:

- Double flow rate compared to predecessor
- One housing nut replaces four screws
- Handwheel with built-in locking mechanism
- Overall length EN 558
- Connecting dimension: ISO 7005 PN 10, EN 1092 PN 10, DIN 2501 PN 10, BS 4504 PN 10
- Flat sealing faces

Option:

- Individual configuration of the valve (see diagram)
- Self adjusting multifunctional module with integrated limit switches

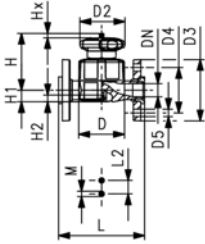

d [mm]	DN [mm]	PN	kv-value ($\Delta p=1$ bar) [l/min]	NBR Code	EPDM Code	PTFE/EPDM Code
20	15	10	125	161 517 002	161 517 012	161 517 032
25	20	10	271	161 517 003	161 517 013	161 517 033
32	25	10	481	161 517 004	161 517 014	161 517 034
40	32	10	759	161 517 005	161 517 015	161 517 035
50	40	10	1263	161 517 006	161 517 016	161 517 036
63	50	10	1728	161 517 007	161 517 017	161 517 037

d [mm]	DN [mm]	PN	kv-value ($\Delta p=1$ bar) [l/min]	FPM Code	kg
20	15	10	125	161 517 062	0.493
25	20	10	271	161 517 063	0.660
32	25	10	481	161 517 064	0.895
40	32	10	759	161 517 065	1.352
50	40	10	1263	161 517 066	2.868
63	50	10	1728	161 517 067	2.943

d [mm]	D [mm]	D2 [mm]	D3 [mm]	D4 [mm]	D5 [mm]	L [mm]	L2 [mm]	H [mm]	H1 [mm]	H2 [mm]	M	Lift = Hx [mm]
20	65	65	95	65	14	130	25	73	14	12	M6	7
25	80	65	105	75	14	150	25	81	18	12	M6	10
32	88	87	115	85	14	160	25	107	22	12	M6	13
40	101	87	140	100	18	180	45	115	26	15	M8	15
50	117	135	150	110	18	200	45	148	32	15	M8	19
63	144	135	165	125	18	230	45	166	39	15	M8	25



Diaphragm valve type 317 PVC-U With flanges PVC-U metric

Model:

- Flat sealing faces
- DN 15-65 with backing flange
- DN 80-150 with fixed flange
- Overall length according to EN 558
- Connecting dimension: ISO 7005 PN 10, EN 1092 PN 10, DIN 2501 PN 10, BS 4504 PN 10

Option:

- Handwheel lockable DN15-65 (basic version not lockable)

* DN80 and DN150 fixed flanges metric and Inch ANSI B16.5

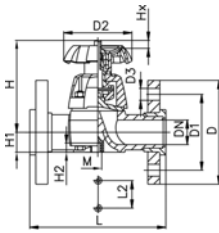

DN 15-65

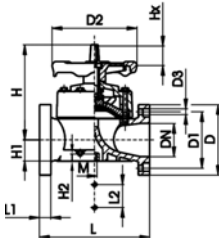

DN 80-100

d [mm]	DN [mm]	Inch	PN	kv-value (Δp=1 bar) [l/min]	NBR Code	EPDM Code	CSM Code
75	65	2 1/2	10	992	161 317 508	161 317 523	161 317 553
* 90	80	3	10	1700	161 317 009	161 317 024	161 317 054
110	100	4	10	2700	161 317 010	161 317 025	161 317 055
* 160	150	6	7	6033	161 317 012	161 317 027	161 317 057

d [mm]	DN [mm]	Inch	PN	kv-value (Δp=1 bar) [l/min]	PTFE with EPDM supp. diaphragm Code	FPM Code	kg
75	65	2 1/2	10	992	161 317 538	161 317 568	5.090
* 90	80	3	10	1700	161 317 039	161 317 069	9.700
110	100	4	10	2700	161 317 040	161 317 070	13.600
* 160	150	6	7	6033	161 317 042	161 317 072	27.000

d [mm]	D [mm]	D1 [mm]	D2 [mm]	D3 [mm]	L [mm]	L1 [mm]	L2 [mm]	L3 [mm]	H [mm]	H1 [mm]	H2 [mm]	M	AL
75	185	145	152	18	290		70		201	46	15	M8	4
* 90	200	160	270	18	310	35	120		265	57	23	M12	8
110	225	180	270	18	350	35	120		304	69	23	M12	8
* 160	285	240	400	23	480	26	100	200	437	108	23	M12	8

d [mm]	Lift = Hx [mm]
75	30
* 90	40
110	50
* 160	70

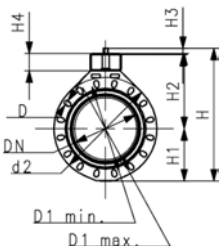
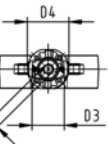
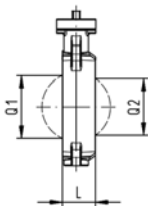
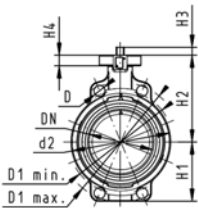

Butterfly valve type 567 PVC-U Bare shaft

Model:

- Connecting dimension: ISO 7005 PN 10, EN 1092 PN 10, DIN 2501 PN 10, ANSI/ASME B 16.5 Class 150, BS 1560: 1989, BS 4504, JIS B 2220
- Up to DN 300: Overall length according to EN558 (DN 50-200: line 25, DN250, 300 line 16), ISO 5752
- Interface F07 for the dimensions DN50-200 according to DIN/ISO 5211
- Interface F10 for the dimensions DN250-300 according to DIN/ISO 5211
- Interface F12 for the Dimensions DN350-400 according to DIN/ISO 5211

d [mm]	DN [mm]	Inch	PN	kv-value ($\Delta p=1$ bar) [l/min]	EPDM Code	FPM Code	kg
63	50	2	10	1470	161 567 802	161 567 822	0.787
75	65	2 1/2	10	2200	161 567 803	161 567 823	0.895
90	80	3	10	3000	161 567 804	161 567 824	1.068
110	100	4	10	6500	161 567 805	161 567 825	2.092
140	125	5	10	11500	161 567 806	161 567 826	2.236
160	150	6	10	16600	161 567 807	161 567 827	3.238
225	200	8	10	39600	161 567 808	161 567 828	5.127
280	250	10	10	51000	161 567 809	161 567 829	11.735
315	300	12	10	73000	161 567 810	161 567 830	15.936
355	350	14	6	90000	161 567 811	161 567 831	45.000
400	400	16	6	115000	161 567 812	161 567 832	55.000

d [mm]	D [mm]	D1 min. [mm]	D1 max. [mm]	d2 [mm]	D3 [mm]	D4 [mm]	H1 [mm]	H2 [mm]	H3 [mm]	H4 [mm]	H5 [mm]	L [mm]
63	19	120	125	104	70	90	77	134	27	23	11	45
75	19	140	145	115	70	90	83	140	27	23	11	46
90	19	150	160	131	70	90	89	146	27	23	11	49
110	19	175	191	161	70	90	104	167	16	23	14	56
140	23	210	216	187	70	90	117	181	16	23	14	64
160	24	241	241	215	70	90	130	189	19	23	17	72
225	23	290	295	267	70	90	158	210	19	23	17	73
280	25	353	362	329	102	125	205	264	40	23	22	113
315	25	400	432	379	102	125	228	285	40	23	22	113
355	29	445	477	535	125	180	268	410	31	100	27	129
400	29	510	540	593	125	180	300	435	31	100	27	169

d [mm]	Q1 [mm]	Q2 [mm]
63	40	
75	54	35
90	67	50
110	88	74
140	113	97
160	139	123
225	178	169
280	210	207
315	256	253
355	325	305
400	353	350



Butterfly valve type 567 PVC-U Hand lever with ratchet settings

Model:

- Connecting dimension: ISO 7005 PN 10, EN 1092 PN 10, DIN 2501 PN 10, ANSI/ASME B 16.5 Class 150, BS 1560: 1989, BS 4504, JIS B 2220
- Up to DN 300: Overall length according to EN558 (DN 50-200: line 25, DN250, 300 line 16), ISO 5752
- We recommend for the dimensions DN250 and DN300 only 6 bar maximum system pressure for the hand lever version

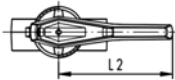
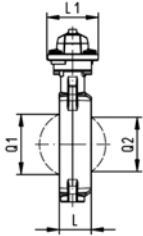
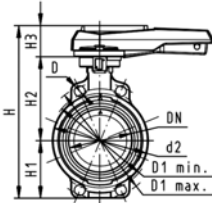

d [mm]	DN [mm]	Inch	PN	kv-value ($\Delta p=1$ bar) [l/min]	EPDM Code	FPM Code	kg
63	50	2	10	1470	161 567 002	161 567 022	1.259
75	65	2 ½	10	2200	161 567 003	161 567 023	1.799
90	80	3	10	3000	161 567 004	161 567 024	1.534
110	100	4	10	6500	161 567 005	161 567 025	2.235
140	125	5	10	11500	161 567 006	161 567 026	2.799
160	150	6	10	16600	161 567 007	161 567 027	3.791
225	200	8	10	39600	161 567 008	161 567 028	6.570
280	250	10	10	55200	161 567 009	161 567 029	12.998
315	300	12	10	80000	161 567 010	161 567 030	19.139

d [mm]	D [mm]	D1 min. [mm]	D1 max. [mm]	d2 [mm]	H [mm]	H1 [mm]	H2 [mm]	H3 [mm]	L [mm]	L1 [mm]	L2 [mm]	Q1 [mm]
63	19	120.0	125.0	104	264	77	134	54	45	106	205	40
75	19	139.7	145.0	115	277	83	140	54	46	106	205	54
90	19	150.0	160.0	131	289	89	146	54	49	106	205	67
110	19	175.0	190.5	161	325	104	167	55	56	106	255	88
140	23	210.0	215.9	187	352	117	181	55	64	106	255	113
160	24	241.3	241.3	215	373	130	189	55	72	106	255	139
225	23	290.0	295.0	267	435	158	210	67	73	140	408	178
280	25	353.0	362.0	329	554	205	264	85	113	149	408	210
315	25	400.0	432.0	379	598	228	285	85	113	149	408	256

d [mm]	Q2 [mm]
63	
75	35
90	50
110	74
140	97
160	123
225	169
280	207
315	253

Butterfly valve type 567 PVC-U Reduction gear with handwheel

Model:

- Connecting dimension: ISO 7005 PN 10, EN 1092 PN 10, DIN 2501 PN 10, ANSI/ASME B 16.5 Class 150, BS 1560: 1989, BS 4504, JIS B 2220
- Up to DN 300: Overall length according to EN558 (DN 50-200: line 25, DN250, 300 line 16), ISO 5752

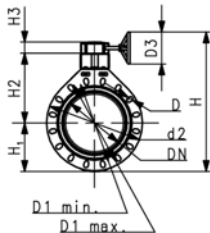
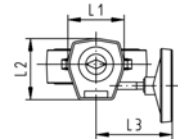
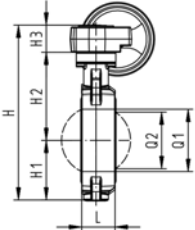
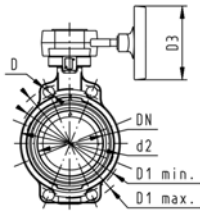

d [mm]	DN [mm]	Inch	PN	kv-value (Δp=1 bar) [l/min]	EPDM Code	FPM Code	kg
63	50	2	10	1470	161 567 042	161 567 062	3.082
75	65	2 ½	10	2200	161 567 043	161 567 063	3.186
90	80	3	10	3000	161 567 044	161 567 064	3.353
110	100	4	10	6500	161 567 045	161 567 065	3.973
140	125	5	10	11500	161 567 046	161 567 066	4.544
160	150	6	10	16600	161 567 047	161 567 067	5.181
225	200	8	10	39600	161 567 048	161 567 068	8.339
280	250	10	10	51000	161 567 049	161 567 069	15.115
315	300	12	10	73000	161 567 050	161 567 070	35.000
355	350	14	8	90000	161 567 051	161 567 071	55.000
400	400	16	8	115000	161 567 052	161 567 072	60.000

d [mm]	D [mm]	D1 min. [mm]	D1 max. [mm]	d2 [mm]	D3 [mm]	H1 [mm]	H2 [mm]	H3 [mm]	L [mm]	L1 [mm]	L2 [mm]	L3 [mm]
63	19	120	125	104	150	77	134	50	45	110	120	155
75	19	140	145	115	150	83	140	50	46	110	120	155
90	19	150	160	131	150	89	146	50	49	110	120	155
110	19	175	191	160	150	104	167	50	56	110	120	155
140	23	210	216	187	150	117	181	50	64	110	120	155
160	24	241	241	215	150	130	189	50	72	110	120	155
225	23	290	295	267	150	158	210	50	73	110	120	155
280	25	353	362	329	200	205	264	55	113	130	140	200
315	25	400	432	379	200	228	285	55	113	130	140	200
355	29	445	477	535	200	268	410	69	129	180	168	218
400	29	510	540	595	200	300	435	69	169	180	195	218

d [mm]	Q1 [mm]	Q2 [mm]
63	40	
75	54	35
90	67	50
110	88	74
140	113	97
160	139	123
225	178	169
280	210	207
315	256	253
355	325	305
400	353	350



Integrated position indicator Automatic AU

Size	DN-DN [mm]	Code	kg
1	50 - 80	161 486 858	0.072
2	100 - 125	161 486 304	0.055
3	150 - 200	161 486 009	0.063



Integrated position indicator Automatic AG NI

Size	DN-DN [mm]	Code	kg
1	50 - 80	161 486 859	0.063
2	100 - 125	161 486 305	0.068
3	150 - 200	161 486 010	0.063



Integrated position indicator Electric Namur

Size	DN-DN [mm]	Code	kg
1	50 - 80	161 486 855	0.050
2	100 - 125	161 486 301	0.050
3	150 - 200	161 486 006	0.050



Integrated position indicator Electric PNP

Size	DN-DN [mm]	Code	kg
1	50 - 80	161 486 856	0.056
2	100 - 125	161 486 302	0.056
3	150 - 200	161 486 007	0.056



Integrated position indicator Electric NPN

Size	DN-DN [mm]	Code	kg
1	50 - 80	161 486 857	0.056
2	100 - 125	161 486 303	0.056
3	150 - 200	161 486 008	0.056



Lugstyle butterfly valve type 568 PVC-U Hand lever with ratchet settings

Model:

- Outer body in GGG-40.3 epoxy-coated
- Connecting dimension: ISO 7005 PN10, EN 1092 PN10, DIN 2501 PN10
- Overall length according to EN 558, ISO 5752

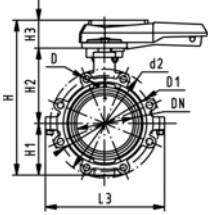

d [mm]	DN [mm]	Inch	PN	kv-value ($\Delta p=1$ bar) [l/min]	EPDM Code	FPM Code	kg
63	50	2	10	1470	161 568 002	161 568 022	3.130
75	65	2 ½	10	2200	161 568 003	161 568 023	3.484
90	80	3	10	3000	161 568 004	161 568 024	4.526
110	100	4	10	6500	161 568 005	161 568 025	6.067
140	125	5	10	11500	161 568 006	161 568 026	8.020
160	150	6	10	16600	161 568 007	161 568 027	10.024
225	200	8	10	39600	161 568 008	161 568 028	15.489

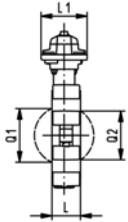

d [mm]	d2 [mm]	D	D1 [mm]	H [mm]	H1 [mm]	H2 [mm]	H3 [mm]	L [mm]	L1 [mm]	L2 [mm]	L3 [mm]	Q1 [mm]	Q2 [mm]
63	150	M16	125	265	77	134	54	45	106	205	150	40	
75	170	M16	145	277	83	140	54	46	106	205	160	54	35
90	184	M16	160	289	89	146	54	49	106	205	205	67	50
110	216	M16	180	326	104	167	55	56	106	255	244	88	74
140	246	M16	210	353	117	181	55	64	106	255	272	113	97
160	273	M20	240	374	130	189	55	72	106	255	297	139	123
225	334	M20	295	435	158	210	67	73	140	408	360	178	169

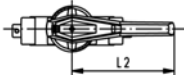



Lugstyle butterfly valve type 568 PVC-U Reduction gear with handwheel

Model:

- Outer body in GGG-40.3 epoxy-coated
- Connecting dimension: ISO 7005 PN10, EN 1092 PN10, DIN 2501 PN10
- Overall length according to EN 558, ISO 5752

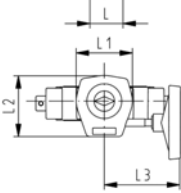
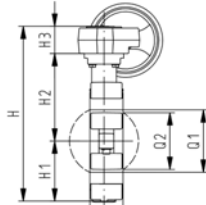
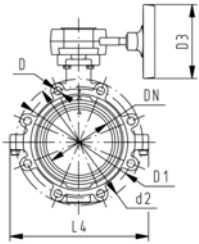

d [mm]	DN [mm]	Inch	PN	kv-value ($\Delta p=1$ bar) [l/min]	EPDM Code	FPM Code	kg
63	50	2	10	1470	161 568 042	161 568 062	5.168
75	65	2 ½	10	2200	161 568 043	161 568 063	5.522
90	80	3	10	3000	161 568 044	161 568 064	6.564
110	100	4	10	6500	161 568 045	161 568 065	8.057
140	125	5	10	11500	161 568 046	161 568 066	10.010
160	150	6	10	16600	161 568 047	161 568 067	12.014
225	200	8	10	39600	161 568 048	161 568 068	16.942

d [mm]	d2 [mm]	D	D1 [mm]	D3 [mm]	H [mm]	H1 [mm]	H2 [mm]	H3 [mm]	L [mm]	L1 [mm]	L2 [mm]	L3 [mm]	L4 [mm]
63	150	M16	125	150	279	77	134	50	45	110	120	155	150
75	170	M16	145	150	291	83	140	50	46	110	120	155	160
90	184	M16	160	150	303	89	146	50	49	110	120	155	205
110	216	M16	180	150	339	104	167	50	56	110	120	155	244
140	246	M16	210	150	366	117	181	50	64	110	120	155	272
160	273	M20	240	150	387	130	189	50	72	110	120	155	297
225	334	M20	295	150	436	158	210	50	73	110	120	155	360

d [mm]	Q1 [mm]	Q2 [mm]
63	40	
75	54	35
90	67	50
110	88	74
140	113	97
160	139	123
225	178	169



Lugstyle butterfly valve type 568 PVC-U Hand lever with ratchet settings

Model:

- Outer body in GGG-40.3 epoxy-coated
- Connecting dimension ANSI/ASME B 16.5 Class 150
- Overall length according to EN 558, ISO 5752

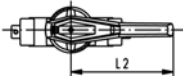
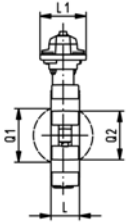
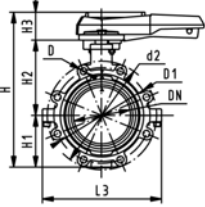

Inch	DN [mm]	PN	kv-value ($\Delta p=1$ bar) [l/min]	EPDM Code	FPM Code	kg
2	50	10	1470	161 568 102	161 568 122	3.130
2 ½	65	10	2200	161 568 103	161 568 123	3.484
3	80	10	3000	161 568 104	161 568 124	3.897
4	100	10	6500	161 568 105	161 568 125	7.571
5	125	10	11500	161 568 106	161 568 126	8.020
6	150	10	16600	161 568 107	161 568 127	10.024
8	200	10	39600	161 568 108	161 568 128	15.489

Inch	d2 [mm]	D	D1 [mm]	H [mm]	H1 [mm]	H2 [mm]	H3 [mm]	L [mm]	L1 [mm]	L2 [mm]	L3 [mm]	Q1 [mm]
2	150	UNC 5/8	121	265	77	134	54	45	106	205	150	40
2 ½	170	UNC 5/8	138	277	83	140	54	46	106	205	160	54
3	177	UNC 5/8	152	289	89	146	54	49	106	205	175	67
4	216	UNC 5/8	191	326	104	167	55	56	106	255	244	88
5	246	UNC 3/4	216	353	117	181	55	64	106	255	272	113
6	273	UNC 3/4	241	374	130	189	55	72	106	255	297	139
8	334	UNC 3/4	298	435	158	210	67	73	140	408	360	178

Inch	Q2 [mm]
2	
2 ½	35
3	50
4	74
5	97
6	123
8	169



Lugstyle butterfly valve type 568 PVC-U Reduction gear with handwheel

Model:

- Outer body in GGG-40.3 epoxy-coated
- Connecting dimension ANSI/ASME B 16.5 Class 150
- Overall length according to EN 558, ISO 5752

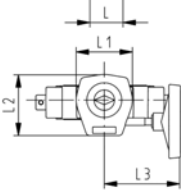
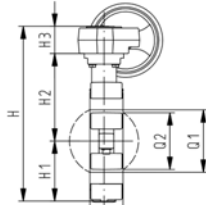
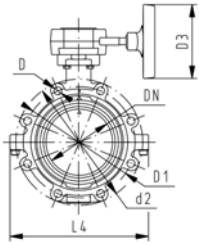

Inch	DN [mm]	PN	kv-value ($\Delta p=1$ bar) [l/min]	EPDM Code	FPM Code	kg
2	50	10	1470	161 568 142	161 568 162	5.168
2 ½	65	10	2200	161 568 143	161 568 163	5.522
3	80	10	3000	161 568 144	161 568 164	5.935
4	100	10	6500	161 568 145	161 568 165	8.057
5	125	10	11500	161 568 146	161 568 166	10.010
6	150	10	16600	161 568 147	161 568 167	12.014
8	200	10	39600	161 568 148	161 568 168	16.942

Inch	d2 [mm]	D	D1 [mm]	D3 [mm]	H [mm]	H1 [mm]	H2 [mm]	H3 [mm]	L [mm]	L1 [mm]	L2 [mm]	L3 [mm]
2	150	UNC 5/8	121	150	279	77	134	50	45	110	120	155
2 ½	170	UNC 5/8	138	150	291	83	140	50	46	110	120	155
3	177	UNC 5/8	152	150	303	89	146	50	49	110	120	155
4	216	UNC 5/8	191	150	339	104	167	50	56	110	120	155
5	246	UNC 3/4	216	150	366	117	181	50	64	110	120	155
6	273	UNC 3/4	241	150	387	130	189	50	72	110	120	155
8	334	UNC 3/4	298	150	436	158	210	50	73	110	120	155

Inch	L4 [mm]	Q1 [mm]	Q2 [mm]
2	150	40	
2 ½	160	54	35
3	175	67	50
4	244	88	74
5	272	113	97
6	297	139	123
8	360	178	169

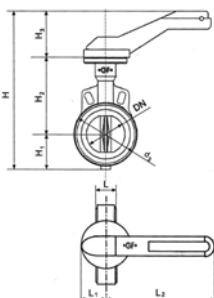

Metal - butterfly valve type 037M

With hand lever

Model:

- Housing: Aluminium ASTM S 12A, Rilsan® coated
- Seatliner available in EPDM and FPM

d [mm]	DN [mm]	Inch	PN	kv-value ($\Delta p=1$ bar) [l/min]	Cv value ($\Delta p=1$ psi) [gal (US) / min]	Disc: ductile iron/ Rilsan® coated EPDM Code	Disc: ductile iron/ Rilsan® coated FPM Code
63	50	2	10	3140	220	199 037 000	199 037 013
75	65	2 ½	10	4570	320	199 037 001	199 037 014
90	80	3	10	7140	500	199 037 002	199 037 015
110	100	4	10	11710	800	199 037 003	199 037 016
140	125	5	10	18570	1300	199 037 004	199 037 017
160	150	6	10	27130	1900	199 037 005	199 037 018
225	200	8	10	47130	3330	199 037 006	199 037 019
280	250	10	10	77110	5400	199 037 007	199 037 020
315	300	12	10	114240	8000	199 037 008	199 037 021

d [mm]	DN [mm]	Inch	PN	kv-value ($\Delta p=1$ bar) [l/min]	Cv value ($\Delta p=1$ psi) [gal (US) / min]	Disc: stainless steel EPDM Code	Disc: stainless steel FPM Code
63	50	2	10	3140	220	199 037 200	199 037 213
75	65	2 ½	10	4570	320	199 037 201	199 037 214
90	80	3	10	7140	500	199 037 202	199 037 215
110	100	4	10	11710	800	199 037 203	199 037 216
140	125	5	10	18570	1300	199 037 204	199 037 217
160	150	6	10	27130	1900	199 037 205	199 037 218
225	200	8	10	47130	3330	199 037 206	199 037 219
280	250	10	10	77110	5400	199 037 207	199 037 220
315	300	12	10	114240	8000	199 037 208	199 037 221

d [mm]	DN [mm]	Inch	PN	kv-value ($\Delta p=1$ bar) [l/min]	Cv value ($\Delta p=1$ psi) [gal (US) / min]	Disc: Alu-bronze EPDM Code	Disc: Alu-bronze FPM Code
63	50	2	10	3140	220	199 037 400	199 037 413
75	65	2 ½	10	4570	320	199 037 401	199 037 414
90	80	3	10	7140	500	199 037 402	199 037 415
110	100	4	10	11710	800	199 037 403	199 037 416
140	125	5	10	18570	1300	199 037 404	199 037 417
160	150	6	10	27130	1900	199 037 405	199 037 418
225	200	8	10	47130	3330	199 037 406	199 037 419
280	250	10	10	77110	5400	199 037 407	199 037 420
315	300	12	10	114240	8000	199 037 408	199 037 421

d [mm]	DN [mm]	d3 [mm]	L [mm]	L1 [mm]	L2 [mm]	H [mm]	H1 [mm]	H2 [mm]	H3 [mm]
63	50	95	43	45	220	290	53	140	95
75	65	114	46	45	220	312	63	152	95
90	80	131	46	45	220	327	71	159	95
110	100	152	52	45	220	360	87	178	95
140	125	182	56	45	320	388	102	191	95
160	150	209	56	45	320	416	118	203	95

table continued next page

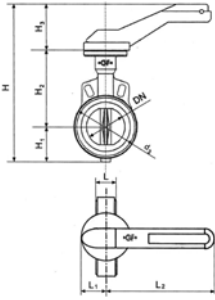

d [mm]	DN [mm]	d3 [mm]	L [mm]	L1 [mm]	L2 [mm]	H [mm]	H1 [mm]	H2 [mm]	H3 [mm]
225	200	262	60	45	320	489	149	245	95
280	250	331	68	63	560	525	200	275	50
315	300	380	78	63	560	592	227	315	50

Metal - butterfly valve type 037G Reduction gear with handwheel

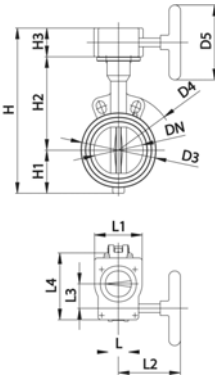

d [mm]	DN [mm]	Inch	PN	kv-value ($\Delta p=1$ bar) [l/min]	Cv value ($\Delta p=1$ psi) [gal (US) / min]	Disc: ductile iron/ Rilsan® coated EPDM Code	Disc: ductile iron/ Rilsan® coated FPM Code
63	50	2	10	3140	220	199 037 026	199 037 039
75	65	2 ½	10	4570	320	199 037 027	199 037 040
90	80	3	10	7140	500	199 037 028	199 037 041
110	100	4	10	11710	820	199 037 029	199 037 042
140	125	5	10	18570	1300	199 037 030	199 037 043
160	150	6	10	27130	1900	199 037 031	199 037 044
225	200	8	10	47130	3330	199 037 032	199 037 045
280	250	10	10	77110	5400	199 037 033	199 037 046
315	300	12	10	114240	8000	199 037 034	199 037 047

d [mm]	DN [mm]	Inch	PN	kv-value ($\Delta p=1$ bar) [l/min]	Cv value ($\Delta p=1$ psi) [gal (US) / min]	Disc: stainless steel EPDM Code	Disc: stainless steel FPM Code
63	50	2	10	3140	220	199 037 226	199 037 239
75	65	2 ½	10	4570	320	199 037 227	199 037 240
90	80	3	10	7140	500	199 037 228	199 037 241
110	100	4	10	11710	820	199 037 229	199 037 242
140	125	5	10	18570	1300	199 037 230	199 037 243
160	150	6	10	27130	1900	199 037 231	199 037 244
225	200	8	10	47130	3330	199 037 232	199 037 245
280	250	10	10	77110	5400	199 037 233	199 037 246
315	300	12	10	114240	8000	199 037 234	199 037 247

d [mm]	DN [mm]	Inch	PN	kv-value ($\Delta p=1$ bar) [l/min]	Cv value ($\Delta p=1$ psi) [gal (US) / min]	Disc: Alu-bronze EPDM Code
63	50	2	10	3140	220	199 037 426
75	65	2 ½	10	4570	320	199 037 427
90	80	3	10	7140	500	199 037 428
110	100	4	10	11710	820	199 037 429
140	125	5	10	18570	1300	199 037 430
160	150	6	10	27130	1900	199 037 431
225	200	8	10	47130	3330	199 037 432
280	250	10	10	77110	5400	199 037 433
315	300	12	10	114240	8000	199 037 434

table continued next page

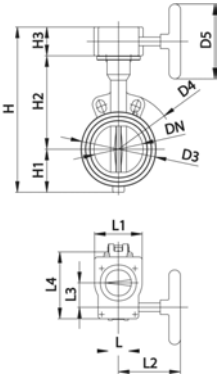

d [mm]	DN [mm]	Inch	PN	kv-value ($\Delta p=1$ bar) [l/min]	Cv value ($\Delta p=1$ psi) [gal (US) / min]	Disc: Alu-bronze FPM Code	kg
63	50	2	10	3140	220	199 037 439	3.300
75	65	2 1/2	10	4570	320	199 037 440	3.600
90	80	3	10	7140	500	199 037 441	3.800
110	100	4	10	11710	820	199 037 442	4.800
140	125	5	10	18570	1300	199 037 443	5.600
160	150	6	10	27130	1900	199 037 444	7.000
225	200	8	10	47130	3330	199 037 445	9.500
280	250	10	10	77110	5400	199 037 446	19.000
315	300	12	10	114240	8000	199 037 447	23.000

d [mm]	D3 [mm]	D4 [mm]	D5 [mm]	L1 [mm]	L2 [mm]	L3 [mm]	L4 [mm]	H [mm]	H1 [mm]	H2 [mm]	H3 [mm]
63	95	165	125	84	152	38	107	253	55	140	58
75	114	185	125	84	152	38	107	275	65	152	58
90	131	190	125	84	152	38	107	290	73	159	58
110	152	229	125	84	152	38	107	323	87	178	58
140	182	254	125	84	152	38	107	351	102	191	58
160	209	285	125	84	152	38	107	379	118	203	58
225	262	343	125	84	152	38	107	452	149	245	58
280	331	333	250	106	184	52	142	542	200	275	67
315	380	353	250	106	184	52	142	609	227	315	67

Metal - butterfly valve type 037G Reduction gear with handwheel ANSI DN350-400

Model:

- Housing: Ductile Iron ASTM A 395, Epoxy coated
- Seatliner available in EPDM, FPM on request
- Disc available in Aluminium Bronze on request
- Connecting dimension ANSI/ASME B 16.5 Class 150
- Up to DN 500: Overall length according to EN558, line 20, ISO 5752

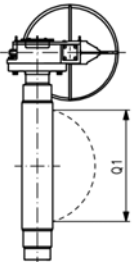

d [mm]	DN [mm]	PN	kv-value ($\Delta p=1$ bar) [l/min]	Disc: Ductile Iron: EPOXY coated EPDM Code	Disc: stainless steel EPDM Code	kg
355	350	10	143360	198 037 020	198 037 030	53.700
400	400	10	186700	198 037 021	198 037 031	81.200

d [mm]	M [inch]	D [mm]	N [mm]	D1 [mm]	D2 [mm]	D3 [mm]	H1 [mm]	H2 [mm]	H3 [mm]	L [mm]	L1 [mm]	L2 [mm]	L3 [mm]
355	1	26	12	476	442	125	291	307	55	78	75	180	282
400	1	26	16	540	193	140	325	342	65	102	88	226	270

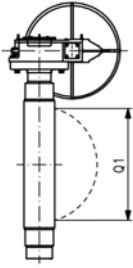

d [mm]	Q1 [mm]
355	332
400	382

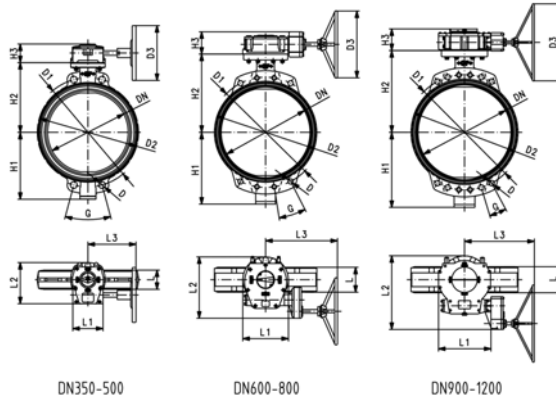

Metal - butterfly valve type 037G Reduction gear with handwheel metric DN350-400

Model:

- Housing: Ductile Iron ASTM A 395, Epoxy coated
- Seatliner available in EPDM, FPM on request
- Disc available in Aluminium Bronze on request
- Connecting dimension: ISO 7005 PN 10, EN 1092 PN 10, DIN 2501 PN 10, BS 4504 PN 10
- Up to DN 500: Overall length according to EN558, line 20, ISO 5752

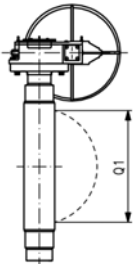

d [mm]	DN [mm]	PN	kv-value ($\Delta p=1$ bar) [l/min]	Disc: Ductile Iron: EPOXY coated EPDM Code	Disc: stainless steel EPDM Code	kg
355	350	10	143360	198 037 000	198 037 010	53.700
400	400	10	186700	198 037 001	198 037 011	81.200

d [mm]	M [mm]	D [mm]	N [mm]	D1 [mm]	D2 [mm]	D3 [mm]	H1 [mm]	H2 [mm]	H3 [mm]	L [mm]	L1 [mm]	L2 [mm]	L3 [mm]
355	20	21	16	460	442	125	291	307	55	78	75	180	282
400	24	25	16	515	193	140	325	342	65	102	88	226	270

table continued next page

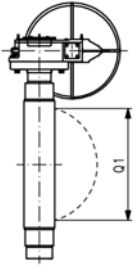

d [mm]	Q1 [mm]
355	332
400	382

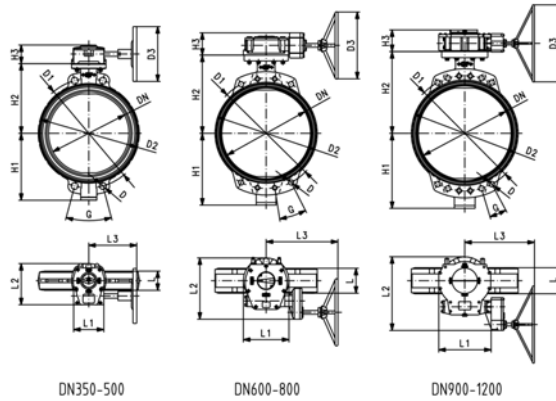

Metal - butterfly valve type 038M With hand lever

Model:

- Seatliner available in EPDM and FPM
- Housing: ductile iron GGG-40/ASTM A536, Rilsan® coated
- Available in ANSI standard upon request
- In case this valve is used at the end of the line, the following pressures must not be exceeded: DN50 to DN150 5,6bar and >DN200 3,5bar

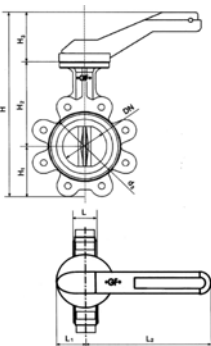

d [mm]	DN [mm]	Inch	PN	kv-value ($\Delta p=1$ bar) [l/min]	Cv value ($\Delta p=1$ psi) [gal (US) / min]	Disc: ductile iron/ Rilsan® coated EPDM Code	Disc: ductile iron/ Rilsan® coated FPM Code
63	50	2	10	3140	220	199 038 000	199 038 013
75	65	2 ½	10	4570	320	199 038 001	199 038 014
90	80	3	10	7140	500	199 038 002	199 038 015
110	100	4	10	11710	820	199 038 003	199 038 016
140	125	5	10	18570	1300	199 038 004	199 038 017
160	150	6	10	27130	1900	199 038 005	199 038 018
225	200	8	10	47130	3330	199 038 006	199 038 019
280	250	10	10	77110	5400	199 038 007	199 038 020
315	300	12	10	114240	8000	199 038 008	199 038 021
d [mm]	DN [mm]	Inch	PN	kv-value ($\Delta p=1$ bar) [l/min]	Cv value ($\Delta p=1$ psi) [gal (US) / min]	Disc: stainless steel EPDM Code	Disc: stainless steel FPM Code
63	50	2	10	3140	220	199 038 200	199 038 213
75	65	2 ½	10	4570	320	199 038 201	199 038 214
90	80	3	10	7140	500	199 038 202	199 038 215
110	100	4	10	11710	820	199 038 203	199 038 216
140	125	5	10	18570	1300	199 038 204	199 038 217
160	150	6	10	27130	1900	199 038 205	199 038 218

table continued next page

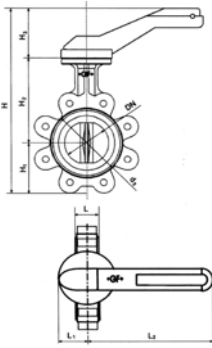

d [mm]	DN [mm]	Inch	PN	kv-value ($\Delta p=1$ bar) [l/min]	Cv value ($\Delta p=1$ psi) [gal (US) / min]	Disc: stainless steel EPDM Code	Disc: stainless steel FPM Code
225	200	8	10	47130	3330	199 038 206	199 038 219
280	250	10	10	77110	5400	199 038 207	199 038 220
315	300	12	10	114240	8000	199 038 208	199 038 221

d [mm]	DN [mm]	Inch	PN	kv-value ($\Delta p=1$ bar) [l/min]	Cv value ($\Delta p=1$ psi) [gal (US) / min]	Disc: Alu-bronze EPDM Code
63	50	2	10	3140	220	199 038 400
75	65	2 ½	10	4570	320	199 038 401
90	80	3	10	7140	500	199 038 402
110	100	4	10	11710	820	199 038 403
140	125	5	10	18570	1300	199 038 404
160	150	6	10	27130	1900	199 038 405
225	200	8	10	47130	3330	199 038 406
280	250	10	10	77110	5400	199 038 407
315	300	12	10	114240	8000	199 038 408

d [mm]	DN [mm]	Inch	PN	kv-value ($\Delta p=1$ bar) [l/min]	Cv value ($\Delta p=1$ psi) [gal (US) / min]	Disc: Alu-bronze FPM Code	kg
63	50	2	10	3140	220	199 038 413	3.800
75	65	2 ½	10	4570	320	199 038 414	4.900
90	80	3	10	7140	500	199 038 415	5.400
110	100	4	10	11710	820	199 038 416	9.100
140	125	5	10	18570	1300	199 038 417	11.000
160	150	6	10	27130	1900	199 038 418	12.800
225	200	8	10	47130	3330	199 038 419	19.300
280	250	10	10	77110	5400	199 038 420	35.000
315	300	12	10	114240	8000	199 038 421	49.000

d [mm]	d3 [mm]	L [mm]	L1 [mm]	L2 [mm]	H [mm]	H1 [mm]	H2 [mm]	H3 [mm]
63	95	43	45	220	298	63	95	152
75	114	46	45	220	320	73	95	178
90	131	46	45	220	335	81	95	200
110	152	52	45	220	370	97	95	229
140	182	56	45	320	398	112	95	254
160	209	56	45	320	420	122	95	280
225	262	60	45	320	489	149	95	343
280	331	68	63	560	573	203	95	406
315	380	78	63	560	651	241	95	483



Metal - butterfly valve type 038G Reduction gear with handwheel

Model:

- Seatliner available in EPDM and FPM
- Housing: ductile iron GGG-40/ASTM A536, Rilsan® coated
- Available in ANSI standard upon request
- In case this valve is used at the end of the line, the following pressures must not be exceeded: DN50 to DN150 5,6bar and >DN200 3,5bar

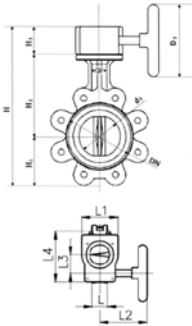

d [mm]	DN [mm]	Inch	PN	kv-value (Δp=1 bar) [l/min]	Cv value (Δp=1 psi) [gal (US) / min]	Disc: ductile iron/ Rilsan® coated EPDM Code	Disc: ductile iron/ Rilsan® coated FPM Code
63	50	2	10	3140	220	199 038 026	199 038 039
75	65	2 ½	10	4570	320	199 038 027	199 038 040
90	80	3	10	7140	500	199 038 028	199 038 041
110	100	4	10	11710	820	199 038 029	199 038 042
140	125	5	10	18570	1300	199 038 030	199 038 043
160	150	6	10	27130	1900	199 038 031	199 038 044
225	200	8	10	47130	3330	199 038 032	199 038 045
280	250	10	10	77110	5400	199 038 033	199 038 046
315	300	12	10	114240	8000	199 038 034	199 038 047

d [mm]	DN [mm]	Inch	PN	kv-value (Δp=1 bar) [l/min]	Cv value (Δp=1 psi) [gal (US) / min]	Disc: stainless steel EPDM Code	Disc: stainless steel FPM Code
63	50	2	10	3140	220	199 038 226	199 038 239
75	65	2 ½	10	4570	320	199 038 227	199 038 240
90	80	3	10	7140	500	199 038 228	199 038 241
110	100	4	10	11710	820	199 038 229	199 038 242
140	125	5	10	18570	1300	199 038 230	199 038 243
160	150	6	10	27130	1900	199 038 231	199 038 244
225	200	8	10	47130	3330	199 038 232	199 038 245
280	250	10	10	77110	5400	199 038 233	199 038 246
315	300	12	10	114240	8000	199 038 234	199 038 247

d [mm]	DN [mm]	Inch	PN	kv-value (Δp=1 bar) [l/min]	Cv value (Δp=1 psi) [gal (US) / min]	Disc: Alu-bronze EPDM Code
63	50	2	10	3140	220	199 038 426
75	65	2 ½	10	4570	320	199 038 427
90	80	3	10	7140	500	199 038 428
110	100	4	10	11710	820	199 038 429
140	125	5	10	18570	1300	199 038 430
160	150	6	10	27130	1900	199 038 431
225	200	8	10	47130	3330	199 038 432
280	250	10	10	77110	5400	199 038 433
315	300	12	10	114240	8000	199 038 434

d [mm]	DN [mm]	Inch	PN	kv-value (Δp=1 bar) [l/min]	Cv value (Δp=1 psi) [gal (US) / min]	Disc: Alu-bronze FPM Code	kg
63	50	2	10	3140	220	199 038 439	5.300
75	65	2 ½	10	4570	320	199 038 440	6.400
90	80	3	10	7140	500	199 038 441	6.900

table continued next page

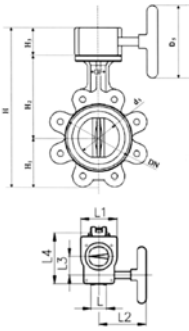

d [mm]	DN [mm]	Inch	PN	kv-value ($\Delta p=1$ bar) [l/min]	Cv value ($\Delta p=1$ psi) [gal (US) / min]	Disc: Alu-bronze FPM Code	kg
110	100	4	10	11710	820	199 038 442	10.400
140	125	5	10	18570	1300	199 038 443	12.300
160	150	6	10	27130	1900	199 038 444	14.100
225	200	8	10	47130	3330	199 038 445	20.400
280	250	10	10	77110	5400	199 038 446	37.000
315	300	12	10	114240	8000	199 038 447	51.000

d [mm]	d3 [mm]	D5 [mm]	L [mm]	L1 [mm]	L2 [mm]	L3 [mm]	L4 [mm]	H [mm]	H1 [mm]	H2 [mm]	H3 [mm]
63	95	125	43	84	152	38	107	261	63	140	58
75	114	125	46	84	152	38	107	283	73	152	58
90	131	125	46	84	152	38	107	298	81	159	58
110	152	125	52	84	152	38	107	333	97	178	58
140	182	125	56	84	152	38	107	361	112	191	58
160	209	125	56	84	152	38	107	383	122	203	58
225	262	125	60	84	152	38	107	452	149	245	58
280	331	250	68	106	152	52	141	545	203	275	67
315	380	250	78	106	152	52	141	623	241	315	67

Angle seat valves

Angle seat valve type 300 PVC-U With solvent cement spigots metric

Model:

- Overall length EN 558

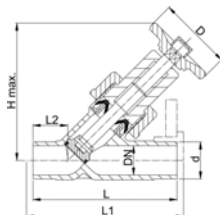

d [mm]	DN [mm]	PN	kv-value ($\Delta p=1$ bar) [l/min]	PE Code	PTFE Code	kg
16	10	10	41	161 300 250	161 300 299	0.128
20	15	10	95	161 300 300	161 300 349	0.168
25	20	10	180	161 300 350	161 300 399	0.255
32	25	10	327	161 300 400	161 300 449	0.389
40	32	10	484	161 300 450	161 300 499	0.590
50	40	10	725	161 300 500	161 300 549	1.000
63	50	10	1130	161 300 550	161 300 599	1.540
75	65	10	1700	161 300 600	161 300 649	2.713
90	80	10	2500	161 300 650	161 300 699	4.097

d [mm]	D [mm]	L [mm]	L1 [mm]	L2 [mm]	H max. [mm]
16	50	114	120	24	105
20	63	124	130	28	126
25	63	144	150	37	140
32	80	154	160	37	166
40	80	174	180	44	191
50	100	194	200	48	233
63	100	224	230	60	264
75	160	284	290	74	335
90	200	300	310	85	390

Angle seat check valves

Angle seat check valve type 303 PVC-U With solvent cement spigots metric

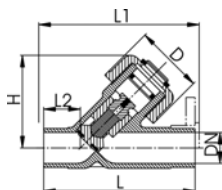

Model:

- For horizontal or vertical installation
- Leakproof from: EPDM 2m, FPM 3m water column
- Specific gravity of piston approx. 2 kg/dm³
- Overall length EN 558

d [mm]	DN [mm]	PN	kv-value ($\Delta p=1$ bar) [l/min]	EPDM Code	FPM Code	kg
16	10	10	41	161 303 005	161 303 030	0.094
20	15	10	95	161 303 006	161 303 031	0.132
25	20	10	180	161 303 007	161 303 032	0.172
32	25	10	327	161 303 008	161 303 033	0.290
40	32	10	484	161 303 009	161 303 034	0.448
50	40	10	725	161 303 010	161 303 035	0.798
63	50	10	1130	161 303 011	161 303 036	1.345
75	65	10	1700	161 303 012	161 303 037	2.499
90	80	10	2500	161 303 013	161 303 038	3.540

d [mm]	D [mm]	L [mm]	L1 [mm]	L2 [mm]	H [mm]
16	39	114	120	24	58
20	43	124	130	28	65
25	47	144	150	37	75
32	56	154	160	37	90
40	64	174	180	44	102
50	82	194	200	48	123
63	95	224	230	60	144
75	92	284	290	74	186
90	104	300	310	85	204

Angle seat valve bracket type 123 PVC-U

Model:

- Can be fitted to existing installations without interrupting their operation
- Easily assembled without tools
- For Angle Seat Valves Type 300



d [mm]	DN [mm]	Code	kg
16	10	161 123 250	0.114
20	15	161 123 300	0.146
25	20	161 123 350	0.230
32	25	161 123 400	0.289
40	32	161 123 450	0.374

table continued next page

d	L	L1	L2	L3	L4	L5	L6	H	H1	H2	H3	H4	
[mm]	[mm]	[mm]	[mm]	[mm]	[mm]	[mm]	[mm]	[mm]	[mm]	[mm]	[mm]	[mm]	
16	62	8	7	78	67	10	22	76	55	11	15	9	
20	65	9	7	82	74	10	25	86	65	11	17	11	
25	73	9	8	91	87	11	30	100	76	12	20	17	
32	84	9	8	102	104	13	35	102	78	12	23	14	
40	90	9	8	107	122	15	42	116	85	16	27	17	

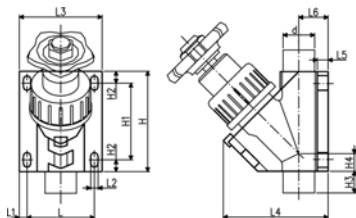

Ball check valves

Ball check valve type 360 PVC-U With solvent cement sockets Inch BS

Model:

- For easy installation and removal
- Ball is sealing at a minimum water column 2m
- Vibration free even at high flow velocity

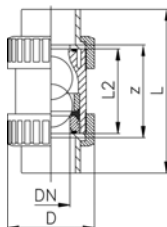

Inch	DN [mm]	PN	kv-value ($\Delta p=1$ bar) [l/min]	EPDM Code	FPM Code	kg
3/8	10	16	170	161 360 521	161 360 531	0.123
1/2	15	16	150	161 360 522	161 360 532	0.123
3/4	20	16	330	161 360 523	161 360 533	0.204
1	25	16	390	161 360 524	161 360 534	0.316
1 1/4	32	16	710	161 360 525	161 360 535	0.520
1 1/2	40	16	900	161 360 526	161 360 536	0.855
2	50	16	1390	161 360 527	161 360 537	1.547

Inch	z [mm]	D [mm]	L [mm]	L2 [mm]
3/8	71	45	99	63
1/2	71	45	102	63
3/4	82	53	120	75
1	87	64	131	79
1 1/4	98	78	150	89
1 1/2	101	92	163	95
2	121	116	197	115

Ball check valve Type 360 PVC-U With solvent cement sockets metric

Model:

- Union ends for easy installation and removal
- Ball is sealing at a minimum water column 2m
- Vibration free even at high flow velocity
- For horizontal or vertical installation

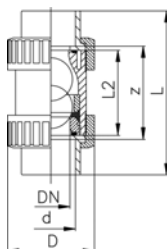

d [mm]	DN [mm]	PN	kv-value ($\Delta p=1$ bar) [l/min]	EPDM Code	FPM Code	kg
16	10	16	170	161 360 401	161 360 411	0.123
20	15	16	150	161 360 402	161 360 412	0.117
25	20	16	330	161 360 403	161 360 413	0.196
32	25	16	390	161 360 404	161 360 414	0.314
40	32	16	710	161 360 405	161 360 415	0.519
50	40	16	900	161 360 406	161 360 416	0.807
63	50	16	1390	161 360 407	161 360 417	1.516

d [mm]	z [mm]	D [mm]	L [mm]	L2 [mm]
16	71	45	99	63
20	71	45	102	63
25	82	53	120	75
32	87	64	131	79

table continued next page

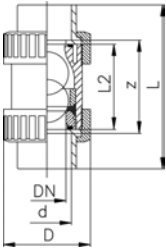

d [mm]	z [mm]	D [mm]	L [mm]	L2 [mm]
40	98	78	150	89
50	101	92	163	95
63	121	116	197	115



Ball check valve Type 360 PVC-U With solvent cement spigots metric

Model:

- Union ends for easy installation and removal
- Ball is sealing at a minimum water column 2m
- Vibration free even at high flow velocity
- For horizontal or vertical installation

* without union ends for easy installation and removal

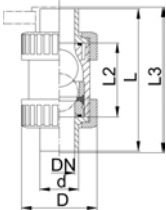

d [mm]	DN [mm]	PN [mm]	kv-value ($\Delta p=1$ bar) [l/min]	EPDM Code	FPM Code	kg
16	10	16	170	161 360 441	161 360 451	0.123
20	15	16	150	161 360 442	161 360 452	0.128
25	20	16	330	161 360 443	161 360 453	0.211
32	25	16	390	161 360 444	161 360 454	0.331
40	32	16	710	161 360 445	161 360 455	0.540
50	40	16	900	161 360 446	161 360 456	0.870
63	50	16	1390	161 360 447	161 360 457	1.554
* 90	80	10	3000	161 360 013	161 360 038	4.509

d [mm]	D [mm]	L [mm]	L2 [mm]	L3 [mm]
16	45	114	63	120
20	45	124	63	130
25	53	144	75	150
32	64	154	79	160
40	78	174	89	180
50	92	194	95	200
63	116	224	115	230
* 90		300		310

Ball check valve Type 360 PVC-U With threaded sockets Rp

Model:

- Union ends for easy installation and removal
- Ball is sealing at a minimum water column 2m
- Vibration free even at high flow velocity
- For horizontal or vertical installation

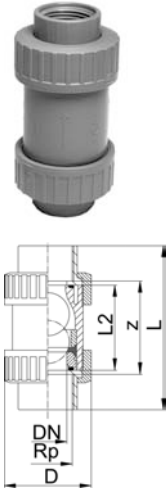

Rp [inch]	DN [mm]	PN	kv-value ($\Delta p=1$ bar) [l/min]	EPDM Code	FPM Code	kg
3/8	10	10	170	161 360 421	161 360 431	0.123
1/2	15	10	150	161 360 422	161 360 432	0.123
3/4	20	10	330	161 360 423	161 360 433	0.204
1	25	10	390	161 360 424	161 360 434	0.316
1 1/4	32	10	710	161 360 425	161 360 435	0.520
1 1/2	40	10	900	161 360 426	161 360 436	0.855
2	50	10	1390	161 360 427	161 360 437	1.547

Rp [inch]	z [mm]	D [mm]	L [mm]	L2 [mm]
3/8	67	45	99	63
1/2	67	45	102	63
3/4	79	53	120	75
1	83	64	131	79
1 1/4	96	78	150	89
1 1/2	109	92	163	95
2	135	116	197	115

Ball check valve Type 360 PVC-U With fixed flanges serrated metric

Model:

- Union ends for easy installation and removal
- Ball is sealing at a minimum water column 2m
- Vibration free even at high flow velocity
- For horizontal or vertical installation
- Overall length EN 558
- Connecting Dimensions: metric 2501 PN 10

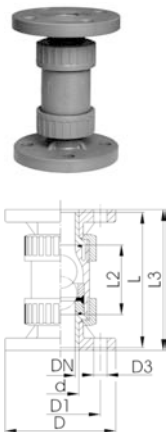

d [mm]	DN [mm]	Inch	PN	kv-value ($\Delta p=1$ bar) [l/min]	EPDM Code	FPM Code	kg
20	15	1/2	16	150	161 360 502	161 360 512	0.327
25	20	3/4	16	330	161 360 503	161 360 513	0.456
32	25	1	16	390	161 360 504	161 360 514	0.694
40	32	1 1/4	16	710	161 360 505	161 360 515	1.155
50	40	1 1/2	16	900	161 360 506	161 360 516	1.589
63	50	2	16	1390	161 360 507	161 360 517	2.605

d [mm]	D [mm]	D1 [mm]	D3 [mm]	L [mm]	L2 [mm]	L3 [mm]
20	95	65	14	124	63	130
25	105	75	14	144	75	150
32	115	84	14	154	79	160
40	140	100	18	174	89	180
50	150	110	18	194	95	200
63	165	125	18	224	115	230

Cone check valves

Check valve type 561 PVC-U With solvent cement sockets Inch BS



Model:

- Designed for easy installation and removal
- Sealing at a minimum water column of 2m
- Vibration free even at high flow velocity
- Flow-optimized return cone, double guided
- For horizontal or vertical installation
- Compact installation length, same as ball valve type 546
- Z-length, end connectors and union nuts **not** compatible with type 360
- New DN65-DN100

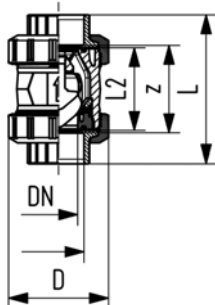

Inch	DN [mm]	PN	kv-value ($\Delta p=1$ bar) [l/min]	EPDM Code	FPM Code	kg
3/8	10	16	190	161 561 061	161 561 071	0.120
1/2	15	16	180	161 561 062	161 561 072	0.120
3/4	20	16	380	161 561 063	161 561 073	0.270
1	25	16	460	161 561 064	161 561 074	0.280
1 1/4	32	16	850	161 561 065	161 561 075	0.490
1 1/2	40	16	1080	161 561 066	161 561 076	0.770
2	50	16	1670	161 561 067	161 561 077	1.370
3	80	16	3600	161 561 069	161 561 079	5.090
4	100	16	4150	161 561 070	161 561 080	8.050

Inch	D [mm]	L [mm]	L2 [mm]	z [mm]
3/8	50	92	56	60
1/2	50	95	56	60
3/4	58	110	65	69
1	68	123	71	75
1 1/4	84	146	85	89
1 1/2	97	157	89	97
2	124	183	101	110
3	200	254	141	151
4	238	301	164	174



Check valve type 562 PVC-U With solvent cement sockets Inch BS

Model:

- Spring loaded, spring made of stainless steel (1.4310)
- Spring available in other materials, see spare parts
- Designed for easy installation and removal
- Sealing at a minimum water column of 0.5m
- Vibration free even at high flow velocity
- Flow-optimized return cone, double guided
- For horizontal or vertical installation
- Compact installation length, same as ball valve type 546
- Z-length, end connectors and union nuts **not** compatible with type 360
- New DN65-DN100

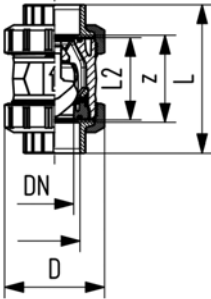

Inch	DN [mm]	PN	kv-value ($\Delta p=1$ bar) [l/min]	EPDM Code	FPM Code	kg
3/8	10	16	190	161 562 061	161 562 071	0.120
1/2	15	16	180	161 562 062	161 562 072	0.120
3/4	20	16	380	161 562 063	161 562 073	0.270
1	25	16	460	161 562 064	161 562 074	0.280
1 1/4	32	16	850	161 562 065	161 562 075	0.490
1 1/2	40	16	1080	161 562 066	161 562 076	0.770
2	50	16	1670	161 562 067	161 562 077	1.370
3	80	16	3600	161 562 069	161 562 079	5.090
4	100	16	4150	161 562 070	161 562 080	8.050

Inch	D [mm]	L [mm]	L2 [mm]	z [mm]
3/8	50	92	56	60
1/2	50	95	56	60
3/4	58	110	65	69
1	68	123	71	75
1 1/4	84	146	85	89
1 1/2	97	157	89	97
2	124	183	101	110
3	200	254	141	151
4	238	301	164	174

Cone check valves

Check valve type 561 PVC-U With solvent cement sockets metric

Model:

- Designed for easy installation and removal
- Sealing at a minimum water column of 2m
- Vibration free even at high flow velocity
- Flow-optimized return cone, double guided
- For horizontal or vertical installation
- Compact installation length, same as ball valve type 546
- Z-length, end connectors and union nuts **not** compatible with type 360
- New DN65-DN100

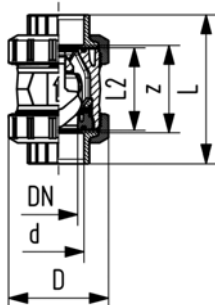

d [mm]	DN [mm]	PN	kv-value ($\Delta p=1$ bar) [l/min]	EPDM Code	FPM Code	kg
16	10	16	190	161 561 001	161 561 011	0.120
20	15	16	180	161 561 002	161 561 012	0.130
25	20	16	380	161 561 003	161 561 013	0.270
32	25	16	460	161 561 004	161 561 014	0.290
40	32	16	850	161 561 005	161 561 015	0.510
50	40	16	1080	161 561 006	161 561 016	0.750
63	50	16	1670	161 561 007	161 561 017	1.340
75	65	16	2950	161 561 008	161 561 018	3.170
90	80	16	3600	161 561 009	161 561 019	5.060
110	100	16	4150	161 561 010	161 561 020	8.170

d [mm]	D [mm]	L [mm]	L2 [mm]	z [mm]
16	50	92	56	64
20	50	95	56	64
25	58	110	65	72
32	68	123	71	79
40	84	146	85	94
50	97	157	89	95
63	124	183	101	107
75	166	233	136	144
90	200	254	141	151
110	238	301	164	174



Check valve type 561 PVC-U With solvent cement spigots metric

Model:

- Designed for easy installation and removal
- Sealing at a minimum water column of 2m
- Vibration free even at high flow velocity
- Flow-optimized return cone, double guided
- For horizontal or vertical installation
- Compact installation length, same as ball valve type 546
- Z-length, end connectors and union nuts **not** compatible with type 360
- New DN65-DN100

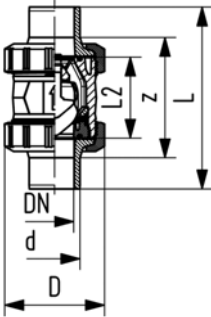

d [mm]	DN [mm]	PN	kv-value ($\Delta p=1$ bar) [l/min]	EPDM Code	FPM Code	kg
16	10	16	190	161 561 041	161 561 051	0.130
20	15	16	180	161 561 042	161 561 052	0.130
25	20	16	380	161 561 043	161 561 053	0.290
32	25	16	460	161 561 044	161 561 054	0.320
40	32	16	850	161 561 045	161 561 055	0.530
50	40	16	1080	161 561 046	161 561 056	0.810
63	50	16	1670	161 561 047	161 561 057	1.450
75	65	16	2950	161 561 048	161 561 058	3.380
90	80	16	3600	161 561 049	161 561 059	5.340
110	100	16	4150	161 561 050	161 561 060	8.540

d [mm]	D [mm]	L [mm]	L2 [mm]
16	50	114	56
20	50	124	56
25	58	144	65
32	68	154	71
40	84	174	85
50	97	194	89
63	124	224	101
75	166	284	136
90	200	300	141
110	238	340	164



Check valve type 561 PVC-U With threaded sockets Rp

Model:

- Designed for easy installation and removal
- Sealing at a minimum water column of 2m
- Vibration free even at high flow velocity
- Flow-optimized return cone, double guided
- For horizontal or vertical installation
- Compact installation length, same as ball valve type 546
- Z-length, end connectors and union nuts **not** compatible with type 360
- New DN65-DN100

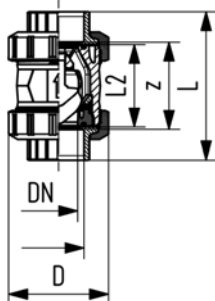

Rp [inch]	DN [mm]	PN	kv-value ($\Delta p=1$ bar) [l/min]	EPDM Code	FPM Code	kg
3/8	10	10	190	161 561 021	161 561 031	0.130
1/2	15	10	180	161 561 022	161 561 032	0.130
3/4	20	10	380	161 561 023	161 561 033	0.280
1	25	10	460	161 561 024	161 561 034	0.300
1 1/4	32	10	850	161 561 025	161 561 035	0.520
1 1/2	40	10	1080	161 561 026	161 561 036	0.790
2	50	10	1670	161 561 027	161 561 037	1.400
2 1/2	65	10	2950	161 561 028	161 561 038	3.820
3	80	10	3600	161 561 029	161 561 039	5.180
4	100	10	4150	161 561 030	161 561 040	8.180

Rp [inch]	D [mm]	L [mm]	L2 [mm]	z [mm]
3/8	50	95	56	69
1/2	50	100	56	67
3/4	58	114	65	78
1	68	127	71	85
1 1/4	84	146	85	100
1 1/2	97	152	89	106
2	124	177	101	121
2 1/2	166	233	136	144
3	200	254	141	151
4	238	301	164	174



Check valve type 561 PVC-U With fixed flanges metric

Model:

- Designed for easy installation and removal
- Sealing at a minimum water column of 2m
- Vibration free even at high flow velocity
- Flow-optimized return cone, double guided
- For horizontal or vertical installation
- Compact installation length, same as ball valve type 546
- Z-length, end connectors and union nuts **not** compatible with type 360
- Installation length according to EN 558-1
- Connecting dimension: ISO 7005 PN10, EN 1092 PN10, DIN 2501 PN10

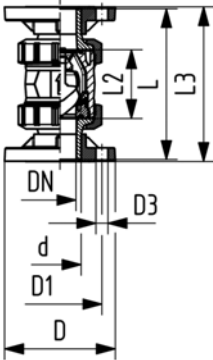

d [mm]	DN [mm]	PN	kv-value ($\Delta p=1$ bar) [l/min]	EPDM Code	FPM Code	kg
20	15	16	180	161 561 082	161 561 092	0.330
25	20	16	380	161 561 083	161 561 093	0.540
32	25	16	460	161 561 084	161 561 094	0.670
40	32	16	850	161 561 085	161 561 095	1.100
50	40	16	1080	161 561 086	161 561 096	1.490
63	50	16	1670	161 561 087	161 561 097	2.440

d [mm]	D [mm]	D1 [mm]	D3 [mm]	L [mm]	L2 [mm]	L3 [mm]
20	95	65	14	124	56	130
25	105	75	14	144	65	150
32	115	85	14	154	71	160
40	140	100	18	174	85	180
50	150	110	18	194	89	200
63	165	125	18	224	101	230



Check valve type 562 PVC-U With solvent cement sockets metric

Model:

- Spring loaded, spring made of stainless steel (1.4310)
- Spring available in other materials, see spare parts
- Designed for easy installation and removal
- Sealing at a minimum water column of 0.5m
- Vibration free even at high flow velocity
- Flow-optimized return cone, double guided
- For horizontal or vertical installation
- Compact installation length, same as ball valve type 546
- Z-length, end connectors and union nuts **not** compatible with type 360
- New DN65-DN100

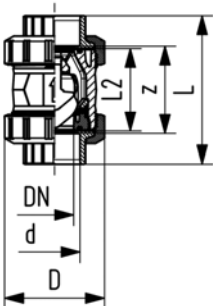

d [mm]	DN [mm]	PN	kv-value ($\Delta p=1$ bar) [l/min]	EPDM Code	FPM Code	kg
16	10	16	190	161 562 001	161 562 011	0.120
20	15	16	180	161 562 002	161 562 012	0.130
25	20	16	380	161 562 003	161 562 013	0.270
32	25	16	460	161 562 004	161 562 014	0.290
40	32	16	850	161 562 005	161 562 015	0.510
50	40	16	1080	161 562 006	161 562 016	0.750

table continued next page

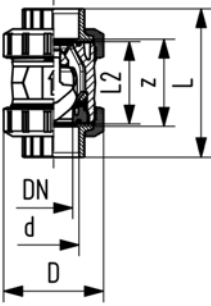

d [mm]	DN [mm]	PN	kv-value (Δp=1 bar) [l/min]	EPDM Code	FPM Code	kg
63	50	16	1670	161 562 007	161 562 017	1.340
75	65	16	2950	161 562 008	161 562 018	3.170
90	80	16	3600	161 562 009	161 562 019	5.060
110	100	16	4150	161 562 010	161 562 020	8.170

d [mm]	D [mm]	L [mm]	L2 [mm]	z [mm]
16	50	92	56	64
20	50	95	56	64
25	58	110	65	72
32	68	123	71	79
40	84	146	85	94
50	97	157	89	95
63	124	183	101	107
75	166	233	136	144
90	200	254	141	151
110	238	301	164	174



Check valve type 562 PVC-U With solvent cement spigots metric

Model:

- Spring loaded, spring made of stainless steel (1.4310)
- Spring available in other materials, see spare parts
- Designed for easy installation and removal
- Sealing at a minimum water column of 0.5m
- Vibration free even at high flow velocity
- Flow-optimized return cone, double guided
- For horizontal or vertical installation
- Compact installation length, same as ball valve type 546
- Z-length, end connectors and union nuts **not** compatible with type 360
- New DN65-DN100

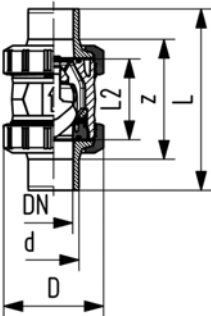

d [mm]	DN [mm]	PN	kv-value (Δp=1 bar) [l/min]	EPDM Code	FPM Code	kg
16	10	16	190	161 562 041	161 562 051	0.130
20	15	16	180	161 562 042	161 562 052	0.130
25	20	16	380	161 562 043	161 562 053	0.290
32	25	16	460	161 562 044	161 562 054	0.320
40	32	16	850	161 562 045	161 562 055	0.530
50	40	16	1080	161 562 046	161 562 056	0.810
63	50	16	1670	161 562 047	161 562 057	1.450
75	65	16	2950	161 562 048	161 562 058	3.380
90	80	16	3600	161 562 049	161 562 059	5.340
110	100	16	4150	161 562 050	161 562 060	8.540

d [mm]	D [mm]	L [mm]	L2 [mm]
16	50	114	56
20	50	124	56
25	58	144	65
32	68	154	71
40	84	174	85

table continued next page

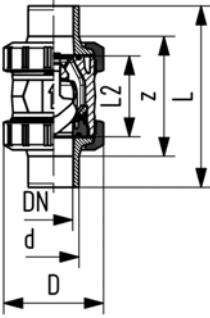

d [mm]	D [mm]	L [mm]	L2 [mm]
50	97	194	89
63	124	224	101
75	166	284	136
90	200	300	141
110	238	340	164



Check valve type 562 PVC-U With threaded sockets Rp

Model:

- Spring loaded, spring made of stainless steel (1.4310)
- Spring available in other materials, see spare parts
- Designed for easy installation and removal
- Sealing at a minimum water column of 0.5m
- Vibration free even at high flow velocity
- Flow-optimized return cone, double guided
- For horizontal or vertical installation
- Compact installation length, same as ball valve type 546
- Z-length, end connectors and union nuts **not** compatible with type 360
- New DN65-DN100

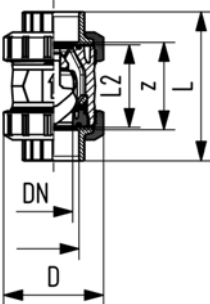

Rp [inch]	DN [mm]	PN	kv-value ($\Delta p=1$ bar) [l/min]	EPDM Code	FPM Code	kg
3/8	10	10	190	161 562 021	161 562 031	0.130
1/2	15	10	180	161 562 022	161 562 032	0.130
3/4	20	10	380	161 562 023	161 562 033	0.280
1	25	10	460	161 562 024	161 562 034	0.300
1 1/4	32	10	850	161 562 025	161 562 035	0.520
1 1/2	40	10	1080	161 562 026	161 562 036	0.790
2	50	10	1670	161 562 027	161 562 037	1.400
2 1/2	65	10	2950	161 562 028	161 562 038	3.820
3	80	10	3600	161 562 029	161 562 039	5.180
4	100	10	4150	161 562 030	161 562 040	8.180

Rp [inch]	D [mm]	L [mm]	L2 [mm]	z [mm]
3/8	50	95	56	69
1/2	50	100	56	67
3/4	58	114	65	78
1	68	127	71	85
1 1/4	84	146	85	100
1 1/2	97	152	89	106
2	124	177	101	121
2 1/2	166	233	136	144
3	200	254	141	151
4	238	301	164	174



Check valve type 562 PVC-U With fixed flanges metric

Model:

- Spring loaded, spring made of stainless steel (1.4310)
- Spring available in other materials, see spare parts
- Designed for easy installation and removal
- Sealing at a minimum water column of 0.5m
- Vibration free even at high flow velocity
- Flow-optimized return cone, double guided
- For horizontal or vertical installation
- Compact installation length, same as ball valve type 546
- Z-length, end connectors and union nuts **not** compatible with type 360
- Installation length according to EN 558-1
- Connecting dimension: ISO 7005 PN10, EN 1092 PN10, DIN 2501 PN10

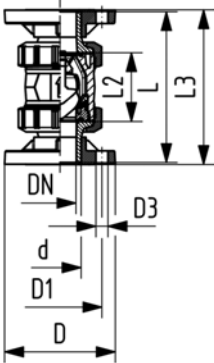

d [mm]	DN [mm]	PN	kv-value ($\Delta p=1$ bar) [l/min]	EPDM Code	FPM Code	kg
20	15	16	180	161 562 082	161 562 092	0.330
25	20	16	380	161 562 083	161 562 093	0.540
32	25	16	460	161 562 084	161 562 094	0.670
40	32	16	850	161 562 085	161 562 095	1.100
50	40	16	1080	161 562 086	161 562 096	1.490
63	50	16	1670	161 562 087	161 562 097	2.440

d [mm]	D [mm]	D1 [mm]	D3 [mm]	L [mm]	L2 [mm]	L3 [mm]
20	95	65	14	124	56	130
25	105	75	14	144	65	150
32	115	85	14	154	71	160
40	140	100	18	174	85	180
50	150	110	18	194	89	200
63	165	125	18	224	101	230

Process control valves

Ventilating and bleed valve Type 591 PVC-U With solvent cement sockets metric



Model:

- With protection cap up to DN50 made from PP-GF, DN65-100 made from POM
- Floater made of PP-H
- Designed for easy installation and removal
- Compact installation length

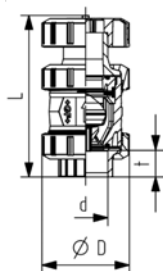

d [mm]	DN [mm]	PN	EPDM Code	FPM Code	kg	D [mm]	L [mm]	t [mm]
16	10	16	161 591 001	161 591 011	0.137	50	118	14
20	15	16	161 591 002	161 591 012	0.147	50	124	16
25	20	16	161 591 003	161 591 013	0.293	58	142	19
32	25	16	161 591 004	161 591 014	0.324	68	157	22
40	32	16	161 591 005	161 591 015	0.562	84	179	26
50	40	16	161 591 006	161 591 016	0.819	97	197	31
63	50	16	161 591 007	161 591 017	1.446	124	229	38
75	65	16	161 591 008	161 591 018	3.170	166	258	45
90	80	16	161 591 009	161 591 019	5.060	200	277	52
110	100	16	161 591 010	161 591 020	8.170	238	320	64

Ventilating and bleed valve Type 591 PVC-U With solvent cement spigots metric



Model:

- With protection cap up to DN50 made from PP-GF, DN65-100 made from POM
- Floater made of PP-H
- Designed for easy installation and removal
- Compact installation length

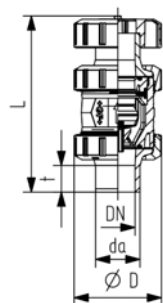

d [mm]	DN [mm]	PN	EPDM Code	FPM Code	kg	D [mm]	L [mm]	t [mm]
16	10	16	161 591 041	161 591 051	0.147	50	129	14
20	15	16	161 591 042	161 591 052	0.147	50	139	16
25	20	16	161 591 043	161 591 053	0.313	58	160	19
32	25	16	161 591 044	161 591 054	0.354	68	172	22
40	32	16	161 591 045	161 591 055	0.582	84	193	26
50	40	16	161 591 046	161 591 056	0.879	97	215	31
63	50	16	161 591 047	161 591 057	1.556	124	249	38
75	65	16	161 591 048	161 591 058	3.380	166	284	44
90	80	16	161 591 049	161 591 059	5.340	200	300	52
110	100	16	161 591 050	161 591 060	8.540	238	340	61



Ventilating and bleed valve Type 591 PVC-U With solvent cement sockets Inch BS

Model:

- With protection cap up to DN50 made from PP-GF, DN65-100 made from POM
- Floater made of PP-H
- Designed for easy installation and removal
- Compact installation length

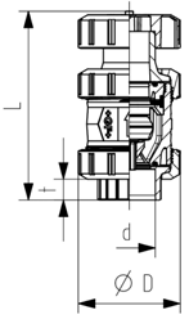

Inch	DN [mm]	PN	EPDM Code	FPM Code	kg	D [mm]	L [mm]	t [mm]
3/8	10	16	161 591 061	161 591 071	0.137	50	118	16
1/2	15	16	161 591 062	161 591 072	0.147	50	124	18
3/4	20	16	161 591 063	161 591 073	0.293	58	142	21
1	25	16	161 591 064	161 591 074	0.324	68	157	24
1 1/4	32	16	161 591 065	161 591 075	0.562	84	179	29
1 1/2	40	16	161 591 066	161 591 076	0.819	97	197	30
2	50	16	161 591 067	161 591 077	1.446	124	229	36
	65	16	161 591 008	161 591 018	3.170	166	258	45
3	80	16	161 591 069	161 591 079	5.060	200	277	51
4	100	16	161 591 070	161 591 080	8.170	238	320	64



Ventilating valve type 595 PVC-U With solvent cement sockets metric

Model:

- With protection cap up to DN50 made from PP-GF, DN65-100 made from POM
- Spring loaded, spring made of NIMONIC 90, HALAR coated
- Spring available in other materials, see spare parts
- Designed for easy installation and removal
- Compact installation length

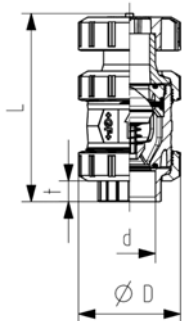

d [mm]	DN [mm]	PN	EPDM Code	FPM Code	kg	D [mm]	L [mm]	t [mm]
16	10	16	161 595 001	161 595 011	0.137	50	118	14
20	15	16	161 595 002	161 595 012	0.147	50	124	16
25	20	16	161 595 003	161 595 013	0.293	58	142	19
32	25	16	161 595 004	161 595 014	0.324	68	157	22
40	32	16	161 595 005	161 595 015	0.562	84	179	26
50	40	16	161 595 006	161 595 016	0.819	97	197	31
63	50	16	161 595 007	161 595 017	1.446	124	229	38
75	65	16	161 595 008	161 595 018	3.170	166	258	45
90	80	16	161 595 009	161 595 019	5.060	200	277	52
110	100	16	161 595 010	161 595 020	8.170	238	320	64

Ventilating valve type 595 PVC-U With solvent cement spigots metric

Model:

- With protection cap up to DN50 made from PP-GF, DN65-100 made from POM
- Spring loaded, spring made of NIMONIC 90, HALAR coated
- Spring available in other materials, see spare parts
- Designed for easy installation and removal
- Compact installation length

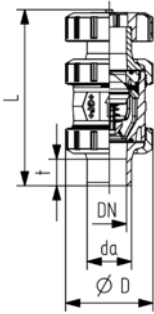

d [mm]	DN [mm]	PN	EPDM Code	FPM Code	kg	D [mm]	L [mm]	t [mm]	
16	10	16	161 595 041	161 595 051	0.147	50	129	14	
20	15	16	161 595 042	161 595 052	0.147	50	139	16	
25	20	16	161 595 043	161 595 053	0.313	58	160	19	
32	25	16	161 595 044	161 595 054	0.354	68	172	22	
40	32	16	161 595 045	161 595 055	0.582	84	193	26	
50	40	16	161 595 046	161 595 056	0.879	97	215	31	
63	50	16	161 595 047	161 595 057	1.556	124	249	38	
75	65	16	161 595 048	161 595 058	3.380	166	284	44	
90	80	16	161 595 049	161 595 059	5.340	200	300	52	
110	100	16	161 595 050	161 595 060	8.540	238	340	61	

Wafer check valves

Wafer check valve type 369 PVC-U Without spring

Model:

- Supporting eyelets for simple fitting
- Suitable for vertical and horizontal mounting

Installation instruction:

- Installation between ISO/DIN (all dimensions) and ANSI flange adaptors (all except DN32 and DN125)
- Installation with ANSI flange adaptor: for wafer check valves DN40 to DN80 you have to use ANSI flange adaptors with the next bigger dimension (example DN40 wafer check valve between DN50 ANSI flange adaptor)
- Centering by body diameter (ISO/DIN by D3, ANSI by D)
- Sealing with special flange gasket (except DN32, o-ring)
- A stabilizing zone of at least 5 times nominal diameter (DN) should be provided before and after the wafer check valve (10 times DN is recommended)
- No direct installation on pump flange or following bend allowed
- The using of PVC-U pipe PN16 is only possible up to d63
- Wafer check valves without reset spring are not recommended for pulsating flows (production of noise)

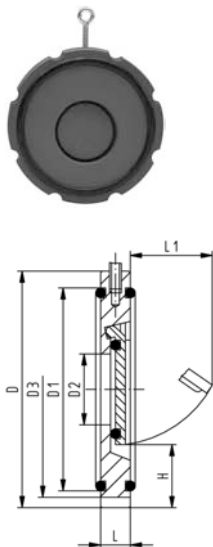

d [mm]	DN [mm]	Inch	PN	EPDM Code	FPM Code	kg	
40	32	1 ¼	6	161 369 002	161 369 022	0.108	
50	40	1 ½	6	161 369 003	161 369 023	0.202	
63	50	2	6	161 369 004	161 369 024	0.277	
75	65	2 ½	6	161 369 005	161 369 025	0.386	
90	80	3	6	161 369 006	161 369 026	0.591	
110	100	4	6	161 369 007	161 369 027	0.667	
140	125	5	6	161 369 009	161 369 029	0.856	
160	150	6	6	161 369 010	161 369 030	1.207	
225	200	8	6	161 369 011	161 369 031	2.306	
280	250	10	6	161 369 012	161 369 032	3.915	
315	300	12	6	161 369 013	161 369 033	5.300	

d [mm]	D [mm]	D1 [mm]	D2 [mm]	D3 [mm]	L [mm]	L1 [mm]	H [mm]	Opening pressure vertical [mbar]	Opening pressure horizontal [mbar]	
40	85	59	18	85	15	22	25	10		1
50	105	74	22	95	16	27	27	10		1
63	124	90	32	109	18	40	29	10		1
75	137	110	40	129	20	55	31	10		1
90	175	130	54	144	20	67	32	10		1
110	175	150	70	164	23	67	31	10		1
140	195	178	92	195	23	94	35	10		1
160	222	192	105	220	26	100	41	10		1
225	279	256	154	275	35	152	38	18		1
280	340	306	192	330	40	180	41	18		1
315	410	342	227	380	45	215	41	18		1

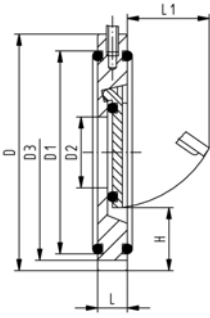

d [mm]	Minimum water column for sealing [m]
40	2.0
50	2.0
63	2.0
75	2.0
90	2.0
110	2.0
140	2.0
160	2.0
225	2.0
280	2.0
315	2.0



Wafer check valve type 369 PVC-U With V4A spring (stainless steel 316)

Model:

- Supporting eyelets for simple fitting
- Suitable for vertical and horizontal mounting

Installation instruction:

- Installation between ISO/DIN (all dimensions) and ANSI flange adaptors (all except DN32 and DN125)
- Installation with ANSI flange adaptor: for wafer check valves DN40 to DN80 you have to use ANSI flange adaptors with the next bigger dimension (example DN40 wafer check valve between DN50 ANSI flange adaptor)
- Centering by body diameter (ISO/DIN by D3, ANSI by D)
- Sealing with special flange gasket (except DN32, o-ring)
- A stabilizing zone of at least 5 times nominal diameter (DN) should be provided before and after the wafer check valve (10 times DN is recommended)
- No direct installation on pump flange or following bend allowed
- The using of PVC-U pipe PN16 is only possible up to d63

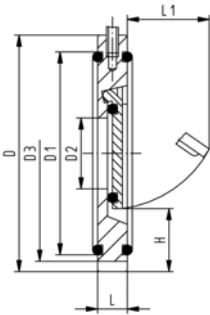

d [mm]	DN [mm]	Inch	PN	EPDM Code	FPM Code	kg
40	32	1 ¼	6	161 369 042	161 369 062	0.107
50	40	1 ½	6	161 369 043	161 369 063	0.206
63	50	2	6	161 369 044	161 369 064	0.250
75	65	2 ½	6	161 369 045	161 369 065	0.320
90	80	3	6	161 369 046	161 369 066	0.390
110	100	4	6	161 369 047	161 369 067	0.684
140	125	5	6	161 369 049	161 369 069	0.750
160	150	6	6	161 369 050	161 369 070	1.100
225	200	8	6	161 369 051	161 369 071	2.100
280	250	10	6	161 369 052	161 369 072	3.500
315	300	12	6	161 369 053	161 369 073	5.300

d [mm]	D [mm]	D1 [mm]	D2 [mm]	D3 [mm]	L [mm]	L1 [mm]	H [mm]	Opening pressure vertical [mbar]	Opening pressure horizontal [mbar]
40	85	59	18	85	15	22	25	30	20
50	105	74	22	95	16	27	27	30	20
63	124	90	32	109	18	40	29	30	20

table continued next page

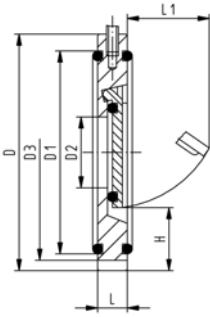

d [mm]	D [mm]	D1 [mm]	D2 [mm]	D3 [mm]	L [mm]	L1 [mm]	H [mm]	Opening pressure vertical [mbar]	Opening pressure horizontal [mbar]
75	137	110	40	129	20	55	31	30	20
90	175	125	54	144	20	67	32	30	20
110	175	150	70	164	23	67	31	30	20
140	195	178	92	195	23	94	35	30	20
160	222	192	105	220	26	100	41	30	20
225	279	256	154	275	35	152	38	38	20
280	340	306	192	330	40	180	41	38	20
315	410	342	227	380	45	215	41	38	20

d [mm]	Minimum water column for sealing [m]
40	2.0
50	2.0
63	2.0
75	2.0
90	2.0
110	2.0
140	2.0
160	2.0
225	2.0
280	2.0
315	2.0



Wafer check valve type 369 PVC-U With Hastelloy C spring

Model:

- Supporting eyelets for simple fitting
- Suitable for vertical and horizontal mounting

Installation instruction:

- Installation between ISO/DIN (all dimensions) and ANSI flange adaptors (all except DN32 and DN125)
- Installation with ANSI flange adaptor: for wafer check valves DN40 to DN80 you have to use ANSI flange adaptors with the next bigger dimension (example DN40 wafer check valve between DN50 ANSI flange adaptor)
- Centering by body diameter (ISO/DIN by D3, ANSI by D)
- Sealing with special flange gasket (except DN32, o-ring)
- A stabilizing zone of at least 5 times nominal diameter (DN) should be provided before and after the wafer check valve (10 times DN is recommended)
- No direct installation on pump flange or following bend allowed
- The using of PVC-U pipe PN16 is only possible up to d63

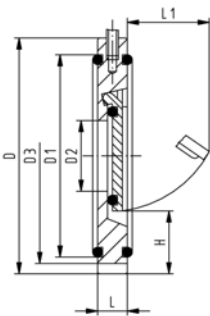

d [mm]	DN [mm]	Inch	PN	EPDM Code	FPM Code	kg
40	32	1 ¼	6	161 369 082	161 369 102	0.130
50	40	1 ½	6	161 369 083	161 369 103	0.160
63	50	2	6	161 369 084	161 369 104	0.277
75	65	2 ½	6	161 369 085	161 369 105	0.320
90	80	3	6	161 369 086	161 369 106	0.390
110	100	4	6	161 369 087	161 369 107	0.550

table continued next page

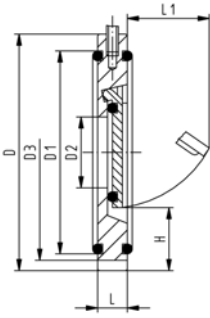

d [mm]	DN [mm]	Inch	PN	EPDM Code	FPM Code	kg	
140	125	5	6	161 369 089	161 369 109	0.750	
160	150	6	6	161 369 090	161 369 110	1.100	
225	200	8	6	161 369 091	161 369 111	2.100	
280	250	10	6	161 369 092	161 369 112	3.500	
315	300	12	6	161 369 093	161 369 113	5.300	

d [mm]	D [mm]	D1 [mm]	D2 [mm]	D3 [mm]	L [mm]	L1 [mm]	H [mm]	Opening pressure vertical [mbar]	Opening pres- sure horizontal [mbar]
40	85	59	18	85	15	22	25	30	20
50	105	74	22	95	16	27	27	30	20
63	124	90	32	109	18	40	29	30	20
75	137	110	40	129	20	55	31	30	20
90	175	125	54	144	20	67	32	30	20
110	175	150	70	164	23	67	31	30	20
140	195	178	92	195	23	94	35	30	20
160	222	192	105	220	26	100	41	30	20
225	279	256	154	275	35	152	38	38	20
280	340	306	192	330	40	180	41	38	20
315	410	342	227	380	45	215	41	38	20

d [mm]	Minimum wa- ter column for sealing [m]
40	2.0
50	2.0
63	2.0
75	2.0
90	2.0
110	2.0
140	2.0
160	2.0
225	2.0
280	2.0
315	2.0

Strainers



Line strainer type 305 PVC-U With solvent cement spigots metric

Model:

- Protects valves, pumps, etc. from becoming soiled
- Easy dismantling for cleaning the screens
- **Screen perforation need be ordered separately**
- Overall length according to EN 558
- supplied with 0.8mm screen in the UK

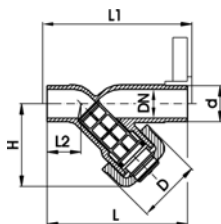

d [mm]	DN [mm]	PN	EPDM Code	FPM Code	kg	D [mm]	L [mm]	L1 [mm]	L2 [mm]	H [mm]
20	15	10	161 305 300	161 305 349	0.134	43	124	130	28	65
25	20	10	161 305 350	161 305 399	0.215	47	144	150	37	76
32	25	10	161 305 400	161 305 449	0.257	56	154	160	37	90
40	32	10	161 305 450	161 305 499	0.386	64	174	180	44	104
50	40	10	161 305 500	161 305 549	0.632	82	194	200	48	124
63	50	10	161 305 550	161 305 599	1.045	95	224	230	60	148
75	65	10	161 305 600	161 305 649	1.871	106	284	290	74	188
90	80	10	161 305 650	161 305 699	2.585	120	300	310	85	205



Line strainer type 305 PVC-U Transparent body with solvent cement spigots metric

Model:

- Protects valves, pumps, etc. from becoming soiled
- Easy dismantling for cleaning the screens
- **Screen perforation need be ordered separately**
- Overall length according to EN 558
- supplied with 0.8mm screen in the UK

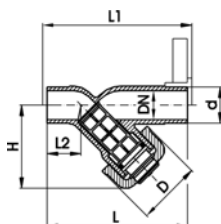

d [mm]	DN [mm]	PN	EPDM Code	FPM Code	kg	D [mm]	L [mm]	L1 [mm]	L2 [mm]	H [mm]
20	15	10	192 305 300	192 305 349	0.100	43	124	130	28	65
25	20	10	192 305 350	192 305 399	0.170	47	144	150	37	76
32	25	10	192 305 400	192 305 449	0.227	56	154	160	37	90
40	32	10	192 305 450	192 305 499	0.346	64	174	180	44	104
50	40	10	192 305 500	192 305 549	0.594	82	194	200	48	124
63	50	10	192 305 550	192 305 599	0.972	95	224	230	60	148
75	65	10	192 305 600	192 305 649	1.838	106	284	290	74	188
90	80	10	192 305 650	192 305 699	2.565	120	300	310	85	205



Line strainer type 306 PVC-U Transparent body with solvent cement spigots ASTM

Model:

- Protects valves, pumps, etc. from becoming soiled
- Easy dismantling for cleaning the screens
- With screen PVC-U, perforation \varnothing 0,8 mm

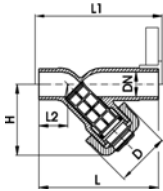

Inch	DN [mm]	PN	EPDM Code	FPM Code	kg	D [mm]	L [mm]	L1 [mm]	L2 [mm]	H [mm]
½	15	10	192 306 300	192 306 349	0.110	43	143	149	37	65
¾	20	10	192 306 350	192 306 399	0.170	47	160	166	45	76
1	25	10	192 306 400	192 306 449	0.255	56	174	180	47	90
1 ¼	32	10	192 306 450	192 306 499	0.409	64	188	194	53	104
1 ½	40	10	192 306 500	192 306 549	0.635	82	205	211	54	124
2	50	10	192 306 550	192 306 599	1.000	95	225	231	63	148
3	80	10	192 306 650	192 306 699	2.800	120	311	321	90	205



Cylindrical screen type 305 PVC-U Screen perforations 0.5 mm

- For line strainers Type 305

d [mm]	Inch	DN [mm]	kv-value ($\Delta p=1$ bar) [l/min]	Code	kg	D [mm]	L [mm]
20	½	15	35	161 305 339	0.001	14	39
25	¾	20	65	161 305 389	0.007	18	48
32	1	25	90	161 305 439	0.002	24	60
40	1 ¼	32	155	161 305 489	0.004	30	71
50	1 ½	40	225	161 305 539	0.007	38	87
63	2	50	370	161 305 589	0.009	48	106
75	2 ½	65	575	161 305 639	0.012	61	100
90	3	80	955	161 305 689	0.016	73	118



Cylindrical screen type 305 PVC-U Screen perforations 0.8 mm

- For line strainers Type 305

d [mm]	DN [mm]	kv-value ($\Delta p=1$ bar) [l/min]	Code	kg	D [mm]	L [mm]
20	15	35	161 305 338	0.005	14	39
25	20	65	161 305 388	0.007	18	48
32	25	90	161 305 438	0.003	24	60
40	32	155	161 305 488	0.004	30	71
50	40	225	161 305 538	0.006	38	87
63	50	370	161 305 588	0.003	48	106
75	65	575	161 305 638	0.012	61	100
90	80	955	161 305 688	0.015	73	118



Cylindrical screen type 305 PVC-U Screen perforations 1.4 mm

d [mm]	DN [mm]	kv-value ($\Delta p=1$ bar) [l/min]	Code	kg	D [mm]	L [mm]
20	15	35	161 305 337	0.001	14	39
25	20	65	161 305 387	0.003	18	48
32	25	90	161 305 437	0.003	24	60
40	32	155	161 305 487	0.004	30	71
50	40	225	161 305 537	0.005	38	87
63	50	370	161 305 587	0.008	48	106
75	65	575	161 305 637	0.011	61	100
90	80	955	161 305 687	0.013	73	118



Cylindrical screen type 305 PVC-U Screen perforations 2.2 mm

d [mm]	DN [mm]	kv-value ($\Delta p=1$ bar) [l/min]	Code	kg	D [mm]	L [mm]
20	15	35	161 305 336	0.005	14	39
25	20	65	161 305 386	0.003	18	48
32	25	90	161 305 436	0.003	24	60
40	32	155	161 305 486	0.003	30	71
50	40	225	161 305 536	0.005	38	87
63	50	370	161 305 586	0.008	48	106
75	65	575	161 305 636	0.009	61	100
90	80	955	161 305 686	0.013	73	118



Screen stainless steel Screen perforation 0.5 mm

Model:

- Stainless Steel A4 Quality (AISI 316)
- For line strainers Type 305

d [mm]	DN [mm]	kv-value ($\Delta p=1$ bar) [l/min]	Code	kg	D [mm]	L [mm]
20	15	35	161 486 100	0.002	14	39
25	20	60	161 486 101	0.004	18	48
32	25	85	161 486 102	0.006	24	60
40	32	130	161 486 103	0.008	30	71
50	40	200	161 486 104	0.014	38	87
63	50	330	161 486 105	0.019	48	106
75	65	460	161 486 106	0.026	61	100
90	80	665	161 486 107	0.034	73	118

Screen assemblies

Screen assembly type 050 PVC-U With solvent cement sockets metric



DN 15 - 50

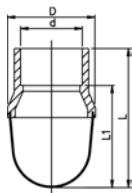

DN 15-50

d [mm]	DN [mm]	Inch	kv-value ($\Delta p=1$ bar) [l/min]	Code	kg	D [mm]	L [mm]	L1 [mm]	perforations ϕ [mm]
20	15	½	105	161 050 026	0.035	50	80	64	2
25	20	¾	228	161 050 027	0.039	50	83	64	2
32	25	1	390	161 050 028	0.046	50	86	64	2
40	32	1 ¼	563	161 050 029	0.144	90	131	105	2
50	40	1 ½	813	161 050 030	0.172	90	136	105	2
63	50	2	1590	161 050 031	0.192	90	143	105	2

Screen assembly type 050 PVC-U With solvent cement sockets metric

Model:

- ¹ Screen with 1 extension and end plate, solvent cemented
- ² Screen with 2 extensions and end plate, solvent cemented
- ³ Screen with 3 extensions and end plate, solvent cemented



DN65-100

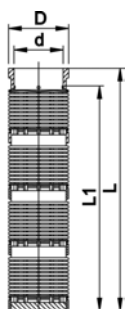

DN 65-100

d [mm]	DN [mm]	kv-value ($\Delta p=1$ bar) [l/min]	Code	kg	D [mm]	L [mm]	L1 [mm]	lamina width [mm]
¹ 75	65	9640	161 050 032	0.837	110	260	216	2.5
² 90	80	14790	161 050 033	0.944	110	345	312	2.5
³ 110	100	15213	161 050 034	1.338	125	490	460	2.5

Screen type 050 PVC-U With solvent cement sockets BS/ASTM

- For Screen Assemblies Type 050, PVC-U, DN 65-100

d [mm]	Inch	DN [mm]	Code	kg	D [mm]	L2 [mm]	lamina width [mm]
75	2 1/2	65	161 090 024	0.447	110	90	2.5
90	3	80	161 090 016	0.300	110	90	2.5
110	4	100	161 090 017	0.440	125	135	2.5

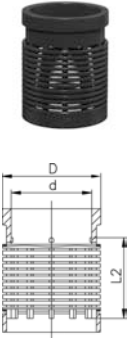

Extention type 050 PVC-U

- For Screen Assemblies Type 050, PVC-U, DN 65-100

d-d [mm]	DN-DN [mm]	Inch	Code	kg	L3 [mm]
75 - 110	65 - 100	2 1/2 - 4	161 090 019	0.249	103



Plate type 050 PVC-U

- For Screen Assemblies Type 050, PVC-U, DN 65-100

d-d [mm]	DN-DN [mm]	Inch	Code	kg	D [mm]	L [mm]
75 - 110	65 - 100	2 1/2 - 4	161 090 018	0.155	100	16

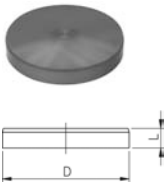

Inspection glass

Inspection glass type 001 PVC-U

Model:

- For visual inspection of the medium in the pipeline
- For horizontal or vertical installation



d [inch]	DN [mm]	PN	EPDM Code	FPM Code	z [mm]	D [mm]	D1 [mm]	L [mm]	
½	15	10	999 950 001	999 950 007					
¾	20	10	999 950 002	999 950 008					
1	25	10	999 950 003	999 950 009					
1 ¼	32	6	999 950 004	999 950 010					
1 ½	40	6	999 950 005	999 950 011					
2	50	6	999 950 006	999 950 012					

Process control valves

Pressure reducing valve type V82 PVC-U With solvent cement spigots metric

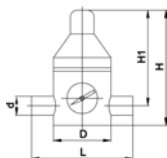

d [mm]	DN [mm]	Pressure range [bar]	EPDM Code	PTFE Code	kg
16	10	0.5 - 10	199 041 012	199 041 022	0.680
20	15	0.5 - 10	199 041 013	199 041 023	0.680
25	20	0.5 - 10	199 041 014	199 041 024	1.350
32	25	0.5 - 10	199 041 015	199 041 025	1.346
40	32	0.5 - 10	199 041 016	199 041 026	2.960
50	40	0.5 - 10	199 041 017	199 041 027	2.960
63	50	0.5 - 10	199 041 018	199 041 028	5.180
75	65	0.5 - 6	199 041 019	199 041 029	10.430
90	80	0.5 - 6	199 041 020	199 041 030	19.630
110	100	0.5 - 4	199 041 021	199 041 031	31.640

d [mm]	D [mm]	L [mm]	H [mm]	H1 [mm]
16	70	134	130	100
20	70	134	130	100
25	100	174	180	134
32	100	174	180	134
40	130	224	230	175
50	130	224	230	175
63	150	244	285	210
75	200	300	350	250
90	250	360	425	305
110	300	420	495	345

Pressure reducing valve type V782 PVC-U With solvent cement spigots metric

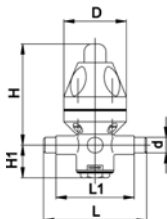

d [mm]	DN [mm]	Pressure range [bar]	EPDM Code	PTFE Code	kg
16	10	0.5 - 10	199 041 060	199 041 066	0.620
20	15	0.5 - 10	199 041 061	199 041 067	0.620
25	20	0.5 - 10	199 041 062	199 041 068	1.636
32	25	0.5 - 10	199 041 063	199 041 069	1.700
40	32	0.5 - 10	199 041 064	199 041 070	6.018
50	40	0.5 - 10	199 041 065	199 041 071	4.840

d [mm]	D [mm]	L [mm]	L1 [mm]	H [mm]	H1 [mm]
16	83	134	102	138	48
20	83	134	102	138	48
25	113	154	110	205	65
32	113	154	110	205	65
40	165	224	162	248	95
50	165	224	162	248	95

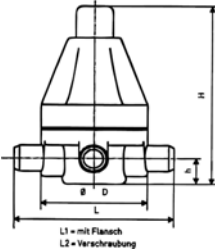

Pressure relief valve type V185 PVC-U With solvent cement spigots metric

d [mm]	DN [mm]	Pressure range [bar]	EPDM Code	PTFE Code	kg
16	10	0.5 - 10	199 041 360	199 041 330	0.400
20	15	0.5 - 10	199 041 361	199 041 331	0.400
25	20	0.5 - 10	199 041 362	199 041 332	0.494
32	25	0.5 - 10	199 041 363	199 041 333	1.310
40	32	0.5 - 10	199 041 364	199 041 334	1.200
50	40	0.5 - 10	199 041 365	199 041 335	6.400
63	50	0.5 - 10	199 041 366	199 041 336	6.500

d [mm]	D [mm]	L [mm]	H [mm]	H1 [mm]
16	83	134	137	20
20	83	134	137	20
25	83	134	137	20
32	112	174	199	27
40	112	174	199	43
50	165	224	290	43
63	165	244	290	43

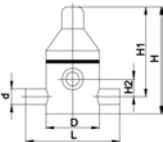

Pressure relief valve type V85 PVC-U With solvent cement spigots metric

d [mm]	DN [mm]	Pressure range [bar]	EPDM Code	PTFE Code	kg
75	65	1.0 - 6	199 041 919	199 041 984	8.200
90	80	1.0 - 6	199 041 940	199 041 985	12.887
110	100	1.0 - 4	199 041 914	199 041 986	22.700

d [mm]	D [mm]	L [mm]	H [mm]	H1 [mm]	H2 [mm]
75	180	284	295	250	70
90	200	300	400	340	95
110	250	380	475	405	110

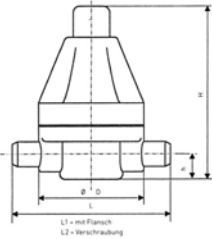

Pressure retaining valve type V186 PVC-U With solvent cement spigots metric

d [mm]	DN [mm]	Pressure range [bar]	EPDM Code	PTFE Code	kg
16	10	0.5 - 10	199 041 379	199 041 309	0.400
20	15	0.5 - 10	199 041 380	199 041 310	0.400
25	20	0.5 - 10	199 041 381	199 041 311	0.475
32	25	0.5 - 10	199 041 382	199 041 312	1.200
40	32	0.5 - 10	199 041 383	199 041 313	1.263
50	40	0.5 - 10	199 041 384	199 041 314	6.400
63	50	0.5 - 10	199 041 385	199 041 315	6.500

d [mm]	D [mm]	L [mm]	H [mm]	H1 [mm]
16	83	134	137	20
20	83	134	137	20
25	83	134	137	20
32	112	174	199	27
40	112	174	199	43
50	165	224	290	43
63	165	244	290	43

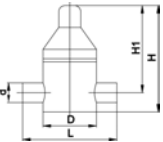

Pressure retaining valve type V86 PVC-U With solvent cement spigots metric

d [mm]	DN [mm]	Pressure range [bar]	EPDM Code	PTFE Code	kg
75	65	0.2 - 4	199 041 922	199 041 989	7.700
75	65	1.0 - 6	199 041 950	199 041 990	7.700
90	80	0.2 - 4	199 041 987	199 041 944	17.700
90	80	1.0 - 6	199 041 988	199 041 991	17.700
110	100	1.0 - 4	199 041 953	199 041 945	19.600

d [mm]	D [mm]	L [mm]	H [mm]	H1 [mm]
75	180	284	275	230
75	180	284	275	230
90	250	360	410	320
90	250	360	410	320
110	250	380	485	415

Gauge guard type Z700 PVC-U
With manometer 0-10 bar

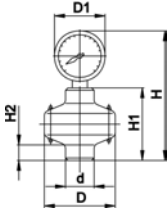

d [mm]	PTFE Code	kg	G_R	D [mm]	D1 [mm]	H [mm]	H1 [mm]	H2 [mm]
25	199 041 000	0.271	¼	72	63	129	71	15
32	199 041 001	0.633	½	100	100	210	90	22

Gauge guard type Z700 PVC-U
With manometer 0-6 bar

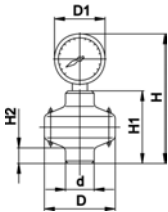

d [mm]	PTFE Code	kg	G_R	D [mm]	D1 [mm]	H [mm]	H1 [mm]	H2 [mm]
25	199 041 292	0.267	¼	72	63	129	71	15
32	199 041 293	0.657	½	100	100	210	90	22

Gauge guard type Z701 PVC-U
Without manometer

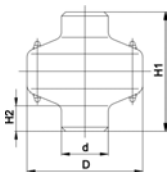

d [mm]	PTFE Code	kg	G_R	D [mm]	H1 [mm]	H2 [mm]
25	199 041 006	0.144	¼	72	71	15
32	199 041 007	0.269	½	100	90	22

Variable area flow meters

Variable area flow meters
Float in PVDF without magnet
With solvent cement sockets PVC-U BS Inch

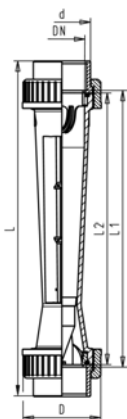

Scale range [l/h]	d [inch]	DN [mm]	Taper tube in PVC-U transp. O-rings in EPDM Code	Taper tube in Polyamid O-rings in EPDM Code
50 - 500	1	25	198 335 400	198 335 420
100 - 1000	1	25	198 335 401	198 335 421
150 - 1500	1 ¼	32	198 335 402	198 335 422
250 - 2500	1 ¼	32	198 335 403	198 335 423
200 - 2000	1 ½	40	198 335 404	198 335 424
300 - 3000	1 ½	40	198 335 405	198 335 425
600 - 6000	1 ½	40	198 335 406	198 335 426
600 - 6000	2	50	198 335 407	198 335 427
1000 - 10000	2	50	198 335 408	198 335 428
1500 - 15000	2	50	198 335 409	198 335 429
2000 - 20000	2 ½	65	198 335 410	198 335 430
3000 - 30000	2 ½	65	198 335 411	198 335 431
8000 - 60000	2 ½	65	198 335 412	198 335 432

Scale range [l/h]	d [inch]	DN [mm]	Taper tube in Polysulfone O-rings in EPDM Code	kg
50 - 500	1	25	198 335 440	0.440
100 - 1000	1	25	198 335 441	0.440
150 - 1500	1 ¼	32	198 335 442	0.620
250 - 2500	1 ¼	32	198 335 443	0.620
200 - 2000	1 ½	40	198 335 444	0.900
300 - 3000	1 ½	40	198 335 445	0.900
600 - 6000	1 ½	40	198 335 446	0.900
600 - 6000	2	50	198 335 447	1.225
1000 - 10000	2	50	198 335 448	1.225
1500 - 15000	2	50	198 335 449	1.225
2000 - 20000	2 ½	65	198 335 450	2.150
3000 - 30000	2 ½	65	198 335 451	2.150
8000 - 60000	2 ½	65	198 335 452	2.150

Scale range [l/h]	D [mm]	L [mm]	L1 [mm]	L2 [mm]	G [inch]
50 - 500	58	385	341	335	1 ½
100 - 1000	58	385	341	335	1 ½
150 - 1500	72	393	341	335	2
250 - 2500	72	393	341	335	2
200 - 2000	83	403	341	335	2 ¼
300 - 3000	83	403	341	335	2 ¼
600 - 6000	83	403	341	335	2 ¼
600 - 6000	101	417	341	335	2 ¾
1000 - 10000	101	417	341	335	2 ¾
1500 - 15000	101	417	341	335	2 ¾

table continued next page

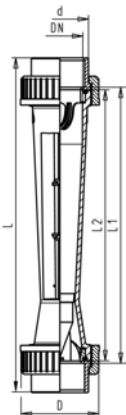

Scale range [l/h]	D [mm]	L [mm]	L1 [mm]	L2 [mm]	G [inch]
2000 - 20000	135	429	341	335	3 1/2
3000 - 30000	135	429	341	335	3 1/2
8000 - 60000	135	429	341	335	3 1/2



Variable area flow meters
Float in PVDF with magnet
With solvent cement sockets PVC-U BS Inch

Model:

- Suitable limit switches see accessories for variable area flow meters

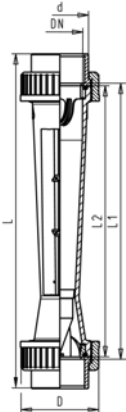

Scale range [l/h]	d [inch]	DN [mm]	Taper tube in PVC-U transp. O- rings in EPDM Code	Taper tube in Polyamid O-rings in EPDM Code
50 - 500	1	25	198 335 500	198 335 520
100 - 1000	1	25	198 335 501	198 335 521
150 - 1500	1 1/4	32	198 335 502	193 355 202
250 - 2500	1 1/4	32	198 335 503	198 335 523
200 - 2000	1 1/2	40	198 335 504	198 335 524
300 - 3000	1 1/2	40	198 335 505	198 335 525
600 - 6000	1 1/2	40	198 335 506	198 335 526
600 - 6000	2	50	198 335 507	198 335 527
1000 - 10000	2	50	198 335 508	198 335 528
1500 - 15000	2	50	198 335 509	198 335 529
2000 - 20000	2 1/2	65	198 335 510	198 335 530
3000 - 30000	2 1/2	65	198 335 511	198 335 531
8000 - 60000	2 1/2	65	198 335 512	198 335 532

Scale range [l/h]	d [inch]	DN [mm]	Taper tube in Polysulfone O- rings in EPDM Code	kg
50 - 500	1	25	198 335 540	0.440
100 - 1000	1	25	198 335 541	0.440
150 - 1500	1 1/4	32	198 335 542	0.620
250 - 2500	1 1/4	32	198 335 543	0.620
200 - 2000	1 1/2	40	198 335 544	0.900
300 - 3000	1 1/2	40	198 335 545	0.900
600 - 6000	1 1/2	40	198 335 546	0.900
600 - 6000	2	50	198 335 547	1.225
1000 - 10000	2	50	198 335 548	1.225
1500 - 15000	2	50	198 335 549	1.225

table continued next page

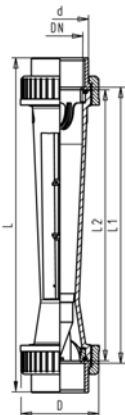

Scale range [l/h]	d [inch]	DN [mm]	Taper tube in Polysulfone O-rings in EPDM Code	kg
2000 - 20000	2 ½	65	198 335 550	2.150
3000 - 30000	2 ½	65	198 335 551	2.150
8000 - 60000	2 ½	65	198 335 552	2.150

Scale range [l/h]	D [mm]	L [mm]	L1 [mm]	L2 [mm]	G [inch]
50 - 500	58	385	341	335	1 ½
100 - 1000	58	385	341	335	1 ½
150 - 1500	72	393	341	335	2
250 - 2500	72	393	341	335	2
200 - 2000	83	403	341	335	2 ¼
300 - 3000	83	403	341	335	2 ¼
600 - 6000	83	403	341	335	2 ¼
600 - 6000	101	417	341	335	2 ¾
1000 - 10000	101	417	341	335	2 ¾
1500 - 15000	101	417	341	335	2 ¾
2000 - 20000	135	429	341	335	3 ½
3000 - 30000	135	429	341	335	3 ½
8000 - 60000	135	429	341	335	3 ½

Short Version
Float in PVDF without magnet
With solvent cement sockets PVC-U BS Inch

Model:

- Union nuts and valve ends in other materials on request

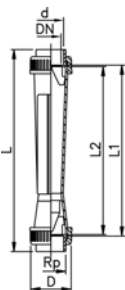

Type	d [inch]	DN [mm]	Scale range [l/h]	Taper tube in Polysulfone O-rings in EPDM Code	D [mm]	L [mm]	L1 [mm]	L2 [mm]
SK50	¾	10	2.5 - 25	198 807 000	35	199	171	165
SK51	¾	10	5 - 50	198 807 001	35	199	171	165
SK52	¾	10	10 - 100	198 807 002	35	199	171	165
SK60	½	15	8 - 80	198 807 003	43	223	191	185
SK61	½	15	15 - 150	198 807 004	43	223	191	185
SK62	½	15	20 - 200	198 807 005	43	223	191	185
SK70	1	25	15 - 150	198 807 006	60	250	206	200
SK71	1	25	30 - 300	198 807 007	60	250	206	200
SK72	1	25	50 - 500	198 807 008	60	250	206	200
SK73	1	25	100 - 1000	198 807 009	60	250	206	200

Short Version
Float in PVDF with magnet
With solvent cement sockets PVC-U BS Inch

Model:

- Suitable limit switches see accessories for variable area flow meters
- Union nuts and valve ends in other materials on request

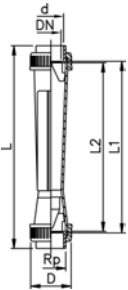

Type	d [inch]	DN [mm]	Scale range [l/h]	Taper tube in Polysulfone O- rings in EPDM Code	D [mm]	L [mm]	L1 [mm]	L2 [mm]
SK500	3/8	10	2.5 - 25	198 807 010	35	199	171	165
SK510	3/8	10	5 - 50	198 807 011	35	199	171	165
SK520	3/8	10	10 - 100	198 807 012	35	199	171	165
SK600	1/2	15	8 - 80	198 807 013	43	223	191	185
SK610	1/2	15	15 - 150	198 807 014	43	223	191	185
SK620	1/2	15	20 - 200	198 807 015	43	223	191	185
SK700	1	25	15 - 150	198 807 016	60	250	206	200
SK710	1	25	30 - 300	198 807 017	60	250	206	200
SK720	1	25	50 - 500	198 807 018	60	250	206	200
SK730	1	25	100 - 1000	198 807 019	60	250	206	200



Variable area flow meter type 335
Float in PVDF without magnet
With solvent cement sockets PVC-U metric

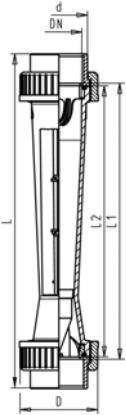

Scale range [l/h]	d [mm]	DN [mm]	Taper tube in PVC-U transp. O-rings in EPDM Code	Taper tube in Polyamid O-rings in EPDM Code
50 - 500	32	25	198 335 000	198 335 020
100 - 1000	32	25	198 335 001	198 335 021
150 - 1500	40	32	198 335 002	198 335 022
250 - 2500	40	32	198 335 003	198 335 023
200 - 2000	50	40	198 335 004	198 335 024
300 - 3000	50	40	198 335 005	198 335 025
600 - 6000	50	40	198 335 006	198 335 026
600 - 6000	63	50	198 335 007	198 335 027
1000 - 10000	63	50	198 335 008	198 335 028
1500 - 15000	63	50	198 335 009	198 335 029
2000 - 20000	75	65	198 335 010	198 335 030
3000 - 30000	75	65	198 335 011	198 335 031
8000 - 60000	75	65	198 335 012	198 335 032

Scale range [l/h]	d [mm]	DN [mm]	Taper tube in Polysulfone O-rings in EPDM Code	kg
50 - 500	32	25	198 335 040	0.464
100 - 1000	32	25	198 335 041	0.528
150 - 1500	40	32	198 335 042	0.698
250 - 2500	40	32	198 335 043	0.561
200 - 2000	50	40	198 335 044	1.057
300 - 3000	50	40	198 335 045	1.038
600 - 6000	50	40	198 335 046	0.991
600 - 6000	63	50	198 335 047	1.455
1000 - 10000	63	50	198 335 048	1.252
1500 - 15000	63	50	198 335 049	1.429
2000 - 20000	75	65	198 335 050	2.639
3000 - 30000	75	65	198 335 051	2.572
8000 - 60000	75	65	198 335 052	2.432

Scale range [l/h]	D [mm]	L [mm]	L1 [mm]	L2 [mm]	G [inch]
50 - 500	58	385	341	335	1 ½
100 - 1000	58	385	341	335	1 ½
150 - 1500	72	393	341	335	2
250 - 2500	72	393	341	335	2
200 - 2000	83	403	341	335	2 ¼
300 - 3000	83	403	341	335	2 ¼
600 - 6000	83	403	341	335	2 ¼
600 - 6000	101	417	341	335	2 ¾
1000 - 10000	101	417	341	335	2 ¾
1500 - 15000	101	417	341	335	2 ¾
2000 - 20000	135	429	341	335	3 ½
3000 - 30000	135	429	341	335	3 ½
8000 - 60000	135	429	341	335	3 ½



Variable area flow meter type 335
Float in PVDF with magnet
With solvent cement sockets PVC-U metric

Model:

- Suitable limit switches see accessories for variable area flow meters

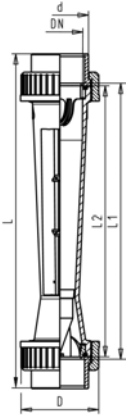

Scale range [l/h]	d [mm]	DN [mm]	Taper tube in PVC-U transp. O-Rings in EPDM Code	Taper tube in Polyamid O-rings in EPDM Code
50 - 500	32	25	198 335 100	198 335 120
100 - 1000	32	25	198 335 101	198 335 121
150 - 1500	40	32	198 335 102	198 335 122
250 - 2500	40	32	198 335 103	198 335 123
200 - 2000	50	40	198 335 104	198 335 124
300 - 3000	50	40	198 335 105	198 335 125
600 - 6000	50	40	198 335 106	198 335 126
600 - 6000	63	50	198 335 107	198 335 127
1000 - 10000	63	50	198 335 108	198 335 128
1500 - 15000	63	50	198 335 109	198 335 129
2000 - 20000	75	65	198 335 110	198 335 130
3000 - 30000	75	65	198 335 111	198 335 131
8000 - 60000	75	65	198 335 112	198 335 132

Scale range [l/h]	d [mm]	DN [mm]	Taper tube in Polysulfone O-rings in EPDM Code	kg
50 - 500	32	25	198 335 140	0.440
100 - 1000	32	25	198 335 141	0.452
150 - 1500	40	32	198 335 142	0.604
250 - 2500	40	32	198 335 143	0.585
200 - 2000	50	40	198 335 144	0.900
300 - 3000	50	40	198 335 145	1.035
600 - 6000	50	40	198 335 146	0.881
600 - 6000	63	50	198 335 147	1.225
1000 - 10000	63	50	198 335 148	1.248
1500 - 15000	63	50	198 335 149	1.409
2000 - 20000	75	65	198 335 150	2.441
3000 - 30000	75	65	198 335 151	2.377
8000 - 60000	75	65	198 335 152	2.150

Scale range [l/h]	D [mm]	L [mm]	L1 [mm]	L2 [mm]	G [inch]
50 - 500	58	385	341	335	1 ½
100 - 1000	58	385	341	335	1 ½
150 - 1500	72	393	341	335	2
250 - 2500	72	393	341	335	2
200 - 2000	83	403	341	335	2 ¼
300 - 3000	83	403	341	335	2 ¼
600 - 6000	83	403	341	335	2 ¼
600 - 6000	101	417	341	335	2 ¾
1000 - 10000	101	417	341	335	2 ¾
1500 - 15000	101	417	341	335	2 ¾

table continued next page

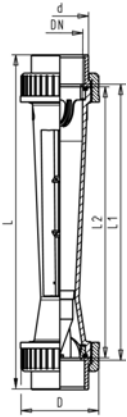

Scale range [l/h]	D [mm]	L [mm]	L1 [mm]	L2 [mm]	G [inch]
2000 - 20000	135	429	341	335	3 ½
3000 - 30000	135	429	341	335	3 ½
8000 - 60000	135	429	341	335	3 ½

Short version
Float in PVDF without magnet
With solvent cement sockets PVC-U metric

Model:

- Union nuts and valve ends in other materials on request

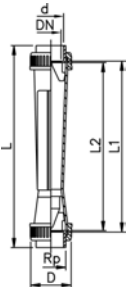

Type	d [mm]	DN [mm]	Scale range [l/h]	Taper tube in Polysulfone O- rings in EPDM Code	Taper tube in PVC-U transp. O- rings in EPDM Code	kg
SK 50	16	10	2.5 - 25	198 801 880	198 803 310	0.081
SK 51	16	10	5 - 50	198 801 881	198 803 311	0.079
SK 52	16	10	10 - 100	198 801 882	198 803 312	0.079
SK 60	20	15	8 - 80	198 801 883	198 803 313	0.127
SK 61	20	15	15 - 150	198 801 884	198 803 314	0.130
SK 62	20	15	20 - 200	198 801 885	198 803 315	0.125
SK 70	32	25	15 - 150	198 801 886	198 803 316	0.256
SK 71	32	25	30 - 300	198 801 887	198 803 317	0.254
SK 72	32	25	50 - 500	198 801 888	198 803 318	0.244
SK 73	32	25	100 - 1000	198 801 889	198 803 319	0.242

Type	D [mm]	L [mm]	L1 [mm]	L2 [mm]	Rp [inch]
SK 50	35	199	171	165	¾
SK 51	35	199	171	165	¾
SK 52	35	199	171	165	¾
SK 60	43	223	191	185	½
SK 61	43	223	191	185	½
SK 62	43	223	191	185	½
SK 70	60	250	206	200	1
SK 71	60	250	206	200	1
SK 72	60	250	206	200	1
SK 73	60	250	206	200	1

Short version
Float in PVDF with magnet
With solvent cement sockets PVC-U metric

Model:

- Union nuts and valve ends in other materials on request
- Suitable limit switches see accessories for variable area flow meters

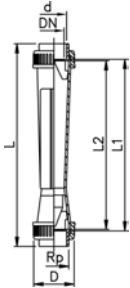

Type	d [mm]	DN [mm]	Scale range [l/h]	Taper tube in Polysulfone O- rings in EPDM Code	Taper tube in PVC-U transp. O- rings in EPDM Code	kg
SK 500	16	10	2.5 - 25	198 801 890	198 803 320	0.081
SK 510	16	10	5 - 50	198 801 891	198 803 321	0.080
SK 520	16	10	10 - 100	198 801 892	198 803 322	0.079
SK 600	20	15	8 - 80	198 801 893	198 803 323	0.129
SK 610	20	15	15 - 150	198 801 894	198 803 324	0.128
SK 620	20	15	20 - 200	198 801 895	198 803 325	0.125
SK 700	32	25	15 - 150	198 801 896	198 803 326	0.301
SK 710	32	25	30 - 300	198 801 897	198 803 327	0.255
SK 720	32	25	50 - 500	198 801 898	198 803 328	0.248
SK 730	32	25	100 - 1000	198 801 899	198 803 329	0.242

Type	D [mm]	L [mm]	L1 [mm]	L2 [mm]	Rp [inch]
SK 500	35	199	171	165	3/8
SK 510	35	199	171	165	3/8
SK 520	35	199	171	165	3/8
SK 600	43	223	191	185	1/2
SK 610	43	223	191	185	1/2
SK 620	43	223	191	185	1/2
SK 700	60	250	206	200	1
SK 710	60	250	206	200	1
SK 720	60	250	206	200	1
SK 730	60	250	206	200	1

Variable area flow meters accessories

Accessories 4-20 mA sensor For type 335 and type 350



Type	d [mm]	DN [mm]	Corresponds to water scale [l/h]	Code	kg
GK 15	32	25	50-500	198 335 962	0.150
GK 15	32	25	100-1000	198 335 963	0.150
GK 15	40	32	150-1500	198 335 964	0.150
GK 15	40	32	250-2500	198 335 965	0.150
GK 15	50	40	200-2000	198 335 966	0.150
GK 15	50	40	300-3000	198 335 967	0.150
GK 15	50	40	600-6000	198 335 968	0.150
GK 15	63	50	600-6000	198 335 969	0.150
GK 15	63	50	1000-10000	198 335 991	0.150
GK 15	63	50	1500-15000	198 335 992	0.150
GK 15	75	65	2000-20000	198 335 993	0.150
GK 15	75	65	3000-30000	198 335 994	0.150
GK 15	75	65	8000-60000	198 335 995	0.150

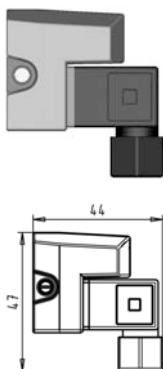

Accessories Limit contacts GK10/GK11 For type 335/350 and short version

Type	Code	kg
GK10 (min.)	198 335 960	0.035
GK11 (max.)	198 335 961	0.034

Integral Systems ProcessPro: Flow

Type 2551 Magmeter Flow Sensor & PVC-U Fitting



Magmeter flow sensor

No moving parts, bi-directional flow, and empty pipe detection

Accurate flow measurement even in dirty fluids

Complete with flow sensor and PVC-U installation tee

Linearity: $\pm 1\%$ of full range

4-20mA output

24vDC

FPM Seals

Other materials, additional relays / outputs and display versions available

*Supplied with saddle

d [mm]	d [inch]	Flow Range [l/min]	Body	Pin	Sensor Type	Code
20		0.500 - 106.000	PP	316L SS	X0	198 820 980
25		0.900 - 188.000	PP	316L SS	X0	198 820 981
32		1.000 - 294.000	PP	316L SS	X0	198 820 982
40		2.000 - 482.000	PP	316L SS	X0	198 820 983
50		4.000 - 753.000	PP	316L SS	X0	198 820 984
63		6.000 - 1177.000	PP	316L SS	X0	198 820 985
* 75	2 ½	10.000 - 1989.000	PP	316L SS	X0	198 820 986
* 90		15.000 - 3013.000	PP	316L SS	X0	198 820 987
* 110		24.000 - 4708.000	PP	316L SS	X0	198 820 988
* 160		53.000 - 10592.000	PP	316L SS	X1	198 820 989
* 225		94.000 - 18831.000	PP	316L SS	X1	198 820 990
	½	0.500 - 106.000	PP	316L SS	X0	198 820 991
	¾	0.900 - 188.000	PP	316L SS	X0	198 820 992
	1	1.000 - 294.000	PP	316L SS	X0	198 820 993
	1 ¼	2.000 - 482.000	PP	316L SS	X0	198 820 994
	1 ½	4.000 - 753.000	PP	316L SS	X0	198 820 995
	2	6.000 - 1177.000	PP	316L SS	X0	198 820 996
	3	15.000 - 3013.000	PP	316L SS	X0	198 820 998
	4	24.000 - 4708.000	PP	316L SS	X0	198 820 999
	6	53.000 - 10592.000	PP	316L SS	X1	198 821 000
	8	94.000 - 18831.000	PP	316L SS	X1	198 821 001



Type 8150 Integral Flow Sensor & PVC-U Fitting

Integral paddlewheel flow sensor

Complete with sensor, PVC-U installation tee fitting, and display

Digital display of flow and totaliser

Linearity: $\pm 1\%$ of full range

Integral battery powered

PVDF Rotor, FPM seals

Other materials available

Temp. Ratings: Max 12.5 bar @ 20°C

*Supplied with saddle



d [mm]	d [inch]	Flow Range	Body	Pin	Sensor Type	Code
20		3.0 - 63.0 L/Min	PP	Titanium	X0	198 820 950
25		6.0 - 113 L/Min	PP	Titanium	X0	198 820 951
32		9.0 - 177 L/Min	PP	Titanium	X0	198 820 952
40		14 - 289 L/Min	PP	Titanium	X0	198 820 953
50		23 - 452 L/Min	PP	Titanium	X0	198 820 954
63		35 - 706 L/Min	PP	Titanium	X0	198 820 955
* 75	2 ½	60 - 1193 L/Min	PP	Titanium	X0	198 820 956
* 90		90 - 1808 L/Min	PP	Titanium	X0	198 820 957
* 110		141 - 2825 L/Min	PP	Titanium	X0	198 820 958
* 160		318 - 6355 L/Min	PP	Titanium	X1	198 820 959
* 225		565 - 11299 L/Min	PP	Titanium	X1	198 820 960
	½	3.0 - 63.0 L/Min	PP	Titanium	X0	198 820 961
	¾	6.0 - 113 L/Min	PP	Titanium	X0	198 820 962
	1	9.0 - 177 L/Min	PP	Titanium	X0	198 820 963
	1 ¼	14 - 289 L/Min	PP	Titanium	X0	198 820 964
	1 ½	23 - 452 L/Min	PP	Titanium	X0	198 820 965
	2	35 - 706 L/Min	PP	Titanium	X0	198 820 966
*	3	90 - 1808 L/Min	PP	Titanium	X0	198 820 968
*	4	141 - 2825 L/Min	PP	Titanium	X0	198 820 969
*	6	318 - 6355 L/Min	PP	Titanium	X1	198 820 970
*	8	565 - 11299 L/Min	PP	Titanium	X1	198 820 971

Type 8550 Integral Flow Sensor & PVC-U Fitting



Integral paddlewheel flow sensor

Complete with sensor, PVC-U installation tee fitting, and transmitter

Digital display of flow and totaliser

Linearity: $\pm 1\%$ of full range

4-20mA output, 1 x Open Collector output

12-24vDC Powered

PVDF Rotor, FPM seals

Other materials, additional relays / outputs available







Temp. Ratings: Max 12.5 bar @ 20°C

*Supplied with saddle



d [mm]	d [inch]	Flow Range	Body	Pin	Sensor Type	Code	
20		1.0 - 63.0 L/Min	PP	Titanium	X0	198 820 900	
25		2.0 - 113 L/Min	PP	Titanium	X0	198 820 901	
32		3.0 - 177 L/Min	PP	Titanium	X0	198 820 902	
40		5 - 289 L/Min	PP	Titanium	X0	198 820 903	
50		8 - 452 L/Min	PP	Titanium	X0	198 820 904	
63		12 - 706 L/Min	PP	Titanium	X0	198 820 905	
* 75	2 ½	20 - 1193 L/Min	PP	Titanium	X0	198 820 906	
* 90		30 - 1808 L/Min	PP	Titanium	X0	198 820 907	
* 110		47 - 2825 L/Min	PP	Titanium	X0	198 820 908	
* 160		106 - 6355 L/Min	PP	Titanium	X1	198 820 909	
* 225		188 - 11299 L/Min	PP	Titanium	X1	198 820 910	
	½	1.0 - 63.0 L/Min	PP	Titanium	X0	198 820 911	
	¾	2.0 - 113 L/Min	PP	Titanium	X0	198 820 912	
	1	3.0 - 177 L/Min	PP	Titanium	X0	198 820 913	
	1 ¼	5 - 289 L/Min	PP	Titanium	X0	198 820 914	
	1 ½	8 - 452 L/Min	PP	Titanium	X0	198 820 915	
	2	12 - 706 L/Min	PP	Titanium	X0	198 820 916	
	3	30 - 1808 L/Min	PP	Titanium	X0	198 820 918	
*	4	47 - 2825 L/Min	PP	Titanium	X0	198 820 919	
*	6	106 - 6355 L/Min	PP	Titanium	X1	198 820 920	
*	8	188 - 11299 L/Min	PP	Titanium	X1	198 820 921	

Accessories

		Page
	Pipe Clips	204
	Solvent Cements	209
	Cleaner	210
	Brushes	211
	Tools for Pipeline Construction	212
	Backing Flanges	213
	Seals	225

Pipe Clips

670610

KLIP-IT pipe clip type 061 PP BS

Model:

- 3/8" - 2": height designed for Ball Valve Type 546 and 543
- Material: Clip and safety clip PP black, UV resistant, bolts galvanized
- **Minimum order quantity: standard packaging SP**

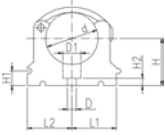

d [inch]	Code	kg	kg/m
1/4	167 061 054	0.003	0.003
3/8	167 061 055	0.007	0.007
1/2	167 061 056	0.007	0.007
3/4	167 061 057	0.008	0.008
1	167 061 058	0.009	0.009
1	167 061 059	0.012	0.012
1 1/2	167 061 060	0.022	0.022
2	167 061 061	0.030	0.030
2 1/2	167 061 012	0.057	0.057
3	167 061 013	0.092	0.092
4	167 061 114	0.114	0.114
5	167 061 016	0.224	0.224

d [inch]	D [mm]	D1 [mm]	L1 [mm]	L2 [mm]	H [mm]	H1 [mm]	H2 [mm]	H3 [mm]	SC
1/4	5	8	11	14	21	10	6	12	M5
3/8	6	10	14	17	23	10	6	16	M5
1/2	6	10	17	19	25	10	6	16	M5
3/4	6	10	19	22	28	10	6	16	M5
1	6	10	24	27	31	10	6	16	M5
1	7	14	34	34	35	10	7	22	M6
1 1/2	7	14	37	37	40	10	7	22	M6
2	9	17	45	45	52	10	10	25	M8
2 1/2	9	17	52	52	58	10	10	25	M8
3	9	17	65	65	65	10	10	28	M8
4	9	17	79	79	81	10	10	28	M8
5	9	17	98	98	110	10	10	32	M8

KLIP-IT pipe clip type 061 PP metric

Model:

- Material: Clip and safety clip PP black, UV resistant, bolts galvanized
- d16 - d63: Height designed for Ball Valve Type 546 and 543
- **Minimum order quantity: standard packagings SP**

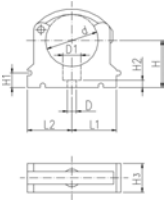

d [mm]	d [inch]	Code	kg
* 10		167 061 003	0.003
* 12		167 061 004	0.003
* 16		167 061 035	0.007
* 20		167 061 036	0.007
* 25		167 061 037	0.009
* 32		167 061 038	0.012
40		167 061 039	0.027
50		167 061 040	0.031
63		167 061 041	0.052
75	2 ½	167 061 012	0.057
90	3	167 061 013	0.092
110	4	167 061 014	0.117
125		167 061 015	0.180
140	5	167 061 016	0.224
160		167 061 017	0.242

d [mm]	D [mm]	D1 [mm]	L1 [mm]	L2 [mm]	H [mm]	H1 [mm]	H2 [mm]	H3 [mm]	SC
* 10	5	8	11	14	20	10	6	12	M4
* 12	5	8	11	14	21	10	6	12	M5
* 16	6	11	14	17	27	10	6	16	M5
* 20	6	11	17	19	27	10	6	16	M5
* 25	6	11	19	22	30	10	6	16	M5
* 32	6	11	24	27	36	10	6	16	M5
40	7	14	34	34	44	10	7	22	M6
50	7	14	37	37	51	10	7	22	M6
63	9	17	45	45	64	10	10	25	M8
75	9	17	52	52	58	10	10	25	M8
90	9	17	65	65	65	10	10	28	M8
110	9	17	79	79	75	10	10	28	M8
125	9	17	88	88	90	10	10	32	M8
140	9	17	98	98	110	10	10	32	M8
160	9	17	109	109	108	10	10	32	M8

KLIP-IT spacer type 061 PP

Model:

- For pipe clips Type 061/061H, PP black, UV resistant
- **Minimum order quantity: standard packaging SP**

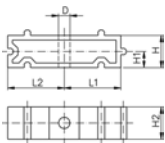

d [mm]	Inch [inch]	Code	kg	D [mm]	L1 [mm]	L2 [mm]	H [mm]	H1 [mm]	H2 [mm]	SC
10 - 12	½ - ¼	167 061 153	0.003	5	11	14	20	10	12	M4
16	¾	167 061 155	0.005	6	14	17	20	10	16	M5
20	½	167 061 156	0.005	6	17	19	20	10	16	M5
25	¾	167 061 157	0.007	6	19	22	20	10	16	M5
32	1	167 061 158	0.008	6	24	27	20	10	16	M5
40	1 ¼	167 061 159	0.015	7	34	34	20	10	22	M6

table continued next page

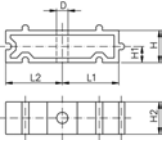

d [mm]	Inch [inch]	Code	kg	D [mm]	L1 [mm]	L2 [mm]	H [mm]	H1 [mm]	H2 [mm]	SC
50	1 ½	167 061 160	0.017	7	37	37	20	10	22	M6
63	2	167 061 161	0.024	9	45	45	20	10	25	M8
75	2 ½	167 061 162	0.027	9	52	52	20	10	25	M8
90	3	167 061 163	0.039	9	65	65	20	10	28	M8
110	4	167 061 164	0.050	9	79	79	20	10	28	M8
125	4 ½	167 061 165	0.059	9	88	88	20	10	32	M8
140	5	167 061 166	0.065	9	98	98	20	10	32	M8
160	6	167 061 167	0.071	9	109	109	20	10	32	M8

KLIP-IT pipe clip type 061 PE metric

Model:

- Material: Clip PE and safety clip PP black, bolts galvanized
- **Minimum order quantity: standard packaging SP**
- Height not designed for ball valve 546 and 543. Please use spacer 73 06 11.

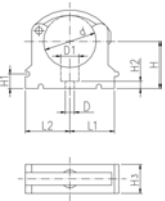

d [mm]	Code	kg	D [mm]	D1 [mm]	L1 [mm]	L2 [mm]	H [mm]	H1 [mm]	H2 [mm]	H3 [mm]	SC
* 10	173 061 003	0.003	5	8	11	14	20	10	6	12	M4
* 12	173 061 004	0.006	5	8	11	14	21	10	6	12	M5
* 16	173 061 005	0.006	6	11	14	17	23	10	6	16	M5
* 20	173 061 006	0.007	6	11	17	19	25	10	6	16	M5
* 25	173 061 007	0.009	6	11	19	22	28	10	6	16	M5
* 32	173 061 008	0.011	6	11	24	27	31	10	6	16	M5
40	173 061 009	0.026	7	14	34	34	35	10	7	22	M6
50	173 061 010	0.028	7	14	37	37	40	10	7	22	M6
63	173 061 011	0.047	9	17	45	45	52	10	10	25	M8
75	173 061 012	0.061	9	17	52	52	58	10	10	25	M8
90	173 061 013	0.098	9	17	65	65	65	10	10	28	M8
110	173 061 014	0.125	9	17	79	79	75	10	10	28	M8
125	173 061 015	0.194	9	17	88	88	90	10	10	32	M8
140	173 061 016	0.243	9	17	98	98	110	10	10	32	M8
160	173 061 017	0.254	9	17	109	109	108	10	10	32	M8

73 06 11



KLIP-IT spacer type 061 PE

Model:

- For pipe clips Type 061, PE black, UV resistant
- **Minimum order quantity: standard packaging SP**

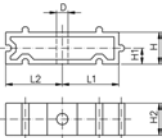

d [mm]	Inch	Code	kg	kg/m
	1/8-1/4	173 061 153	0.003	0.003
16	3/8	173 061 155	0.005	0.005
20	1/2	173 061 156	0.005	0.005
25	3/4	173 061 157	0.006	0.006
32	1	173 061 158	0.008	0.008
40	1 1/4	173 061 159	0.016	0.016
50	1 1/2	173 061 160	0.017	0.017
63	2	173 061 161	0.025	0.025
75	2 1/2	173 061 162	0.027	0.027
90	3	173 061 163	0.040	0.040
110	4	173 061 164	0.050	0.050

table continued next page

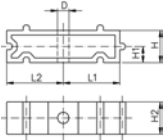

d [mm]	Inch	Code	kg	kg/m	
125	4 1/2	173 061 165	0.059	0.059	
140	5	173 061 166	0.065	0.065	
160	6	173 061 167	0.078	0.078	

d [mm]	D [mm]	L1 [mm]	L2 [mm]	H [mm]	H1 [mm]	H2 [mm]	SC
	5	11	14	20	10	12	M4
16	6	14	17	20	10	16	M5
20	6	17	19	20	10	16	M5
25	6	19	22	20	10	16	M5
32	6	24	27	20	10	16	M5
40	7	34	34	20	10	22	M6
50	7	37	37	20	10	22	M6
63	9	45	45	20	10	25	M8
75	9	52	52	20	10	25	M8
90	9	65	65	20	10	28	M8
110	9	79	79	20	10	28	M8
125	9	88	88	20	10	32	M8
140	9	98	98	20	10	32	M8
160	9	109	109	20	10	32	M8



Pipe clip type 060 PP metric

Model:

- Material: Clip and safety clip PP black, UV resistant, bolts galvanized
- Accidental opening of the safety clip is not possible
- **Minimum order quantity: standard packaging SP or gross packaging GP**
- Clip and safety clip are not assembled in the packaging.
- Pipes with flanges can be installed directly

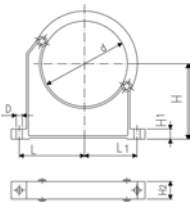

d [mm]	d [inch]	Code	kg	D [mm]	L [mm]	L1 [mm]	H [mm]	H1 [mm]	H2 [mm]	SC
90	3	167 060 038	0.147	9	89	71	105	15	33	M 8
110		167 060 039	0.160	9	94	80	115	15	33	M 8
125		167 060 040	0.249	11	116	91	130	20	35	M10
140	5	167 060 041	0.260	11	121	98	130	20	35	M10
160		167 060 042	0.296	11	131	107	148	20	35	M10
180		167 060 043	0.327	11	143	115	163	20	35	M10
200		167 060 019	0.539	13	152	120	175	25	39	M12
225		167 060 020	0.178	13	165	132	175	25	39	M12
250		167 060 021	0.657	13	183	143	200	25	39	M12
280		167 060 022	0.212	13	198	156	200	25	39	M12
315		167 060 023	0.805	13	219	172	225	25	39	M12
355		167 060 024	1.251	17	275	209	258	30	50	M16
400		167 060 025	1.031	17	300	228	288	30	50	M16



Pipe clip type 060 PP BS

Model:

- Material: Clip and safety clip PP black, UV resistant, bolts galvanized
- Accidental opening of the safety clip is not possible
- **Minimum order quantity: standard packaging SP or gross packaging GP**
- Clip and safety clip are not assembled in the packaging.

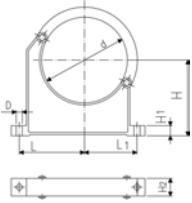

d [inch]	d [mm]	Code	kg	kg/m	D [mm]	L [mm]	L1 [mm]	H [mm]	H1 [mm]	H2 [mm]	SC
3	90	167 060 038	0.147	0.147	9	89	71	105	15	33	M 8
4		167 060 064	0.160	0.160	9	100	82	120	15	33	M 8
5	140	167 060 041	0.260	0.260	11	121	98	130	20	35	M10
6		167 060 067	0.302	0.302	11	136	111	148	25	35	M 10
8		167 060 070	0.514	0.514	13	165	132	175	25	39	M 12

Solvent Cements

99 29 80



Tangit solvent cement for PVC-U

Description	Code	kg
250g Tin	799298003.	0.250
500g Tin	799298002.	0.500

99 29 80



Dytex special solvent cement

Model:

- For PVC-U, PVC-C
- Tin à 675g
- Special solving cement, transparent
- For concentrated acids and strong oxidizing agents the use of Dytex is recommended

Code	kg
799 271 383	0.668



Tangit PVC-U express

4 times faster than standard Tangit

Wait 15 minutes per 1 bar working pressure

Ideal for repair

Pipe size up to DN100

500g tin

Code
799 270 819

99 29 80



Cap for cement

- Cap prevents the evaporation of the solvent whilst using the Tangit cement

Code	kg
799 298 028	0.030

Cleaner

99 29 80



Tangit cleaner

Model:

- For PVC-U, PVC-C, ABS
- 1 litre tin

Code	kg	
799 298 010	0.868	



Dytex solvent/cleaner

Model:

- For PVC-U, PVC-C
- Tin à 500ml

Code	kg	kg/m	
799 271 423	0.675	0.675	

Brushes



Round brush

d-d [mm]	Code	kg	kg/m	
6 - 10	799 299 001	0.004	0.004	
12 - 32	799 299 002	0.006	0.006	



Flat brush

d-d [mm]	Code	kg	kg/m	
40 - 63	799 299 003	0.015	0.015	
75 - 225	799 299 004	0.035	0.035	
250 - 400	799 299 005	0.053	0.053	

Tools for Pipeline Construction

90 30 90



Chamfering tools

- Chamfering tool (15° bevel) for plastic pipes (PVC, ABS, PB, PP, PE). Coated prism surface suitable for clean room applications. Fast and reliable adjustment to the different pipe diameters and wall thickness.

d-d [mm]	Code	kg	kg/m
16 - 200	790 309 003	1.024	1.024
63 - 400	790 309 004	2.548	2.548

90 10 90



PPC Plastic pipe cutter

- For cutting plastic pipes d10 - d160

d-d [mm]	Article	Code	kg	kg/m
10 - 63	PPC 63, s max. = 7.2mm	790 109 001	0.865	0.865
50 - 110	PPC 110, s max. = 12.7mm	790 109 002	1.624	1.624
110 - 160	PPC 160, s max. = 19.0mm	790 109 003	2.212	2.212

90 10 90



Replacement cutting wheels

- for plastic pipe cutter

d-d [mm]	Article	Code	kg	kg/m
10 - 63	SR 63 max. s=7,2 mm	790 109 011	0.004	0.004
50 - 110	SR 110/160 max. s=12,7 mm	790 109 012	0.015	0.015
110 - 160	SR 160 max. s=19,0 mm	790 109 013	0.023	0.023

90 20 20



Plastic pipe cutter

- The KS 355 is the ideal tool for simple right angle precision cutting of PVC, PE and PP pipes, Size range d 160 to 355 mm with a wall thickness up to 40 mm. Including transport box.
- Unique clamping mechanism, no additional tools like belts, chains or reduction inserts necessary

d-d [mm]	Code	kg	kg/m
160 - 355	790 202 001	28.457	28.457

Backing Flanges

24 70 14

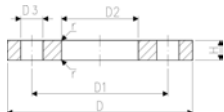

Backing Flange, Galvanised Steel for Socket Systems

Model:

- Galvanised steel, suitable for laying underground
- Connecting dimensions: BS10:1962
- Bolt circle Table D & E

AL: number of holes

* Table D

** Table E

d [mm]	DN [mm]	d [inch]	PN	Code	kg
20	15	½	16	724 701 406	0.220
25	20	¾	16	724 701 407	0.320
32	25	1	16	724 701 408	0.410
40	32	1 ¼	16	724 701 409	0.820
50	40	1 ½	16	724 701 410	1.040
63	50	2	16	724 701 411	1.220
75	65	2 ½	16	724 701 412	1.200
90	80	3	16	724 701 413	1.530
** 110	100		16	724 703 414	1.840
*	100	4	16	724 701 414	1.840
**	100	4	16	724 701 415	1.840
140	125	5	16	724 701 416	2.070
	160	6	16	724 701 417	2.330
225	200	8	6	724 701 419	2.750

d [mm]	DN [mm]	d [inch]	D [mm]	D1 [mm]	D2 [mm]	D3 [mm]	H [mm]	AL	SC
20	15	½	96	67	28	15	7	4	M12x55
25	20	¾	102	73	34	15	7	4	M12x60
32	25	1	115	83	42	15	7	4	M12x60
40	32	1 ¼	121	88	51	15	8	4	M12x70
50	40	1 ½	134	99	62	15	8	4	M12x75
63	50	2	153	115	78	18	8	4	M16x80
75	65	2 ½	165	127	92	18	8	4	M16x85
90	80	3	184	146	110	18	8	4	M16x90
** 110	100		216	178	133	18	8	8	M16x95
*	100	4	216	178	138	18	8	4	M16x95
**	100	4	216	178	138	18	8	8	M16x95
140	125	5	254	210	167	18	8	8	M16x110
	160	6	280	235	200	22	8	8	M20x120
225	200	8	337	292	250	22	8	8	M20x150

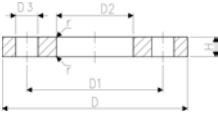

Backing Flange, Galvanised Steel for Socket Systems

Model:

- Galvanised steel, suitable for laying underground
- Connecting dimension: ISO 7005, EN 1092, BS 4504, DIN 2501
- Bolt circle PN10/16

AL: number of holes

*Bolt circle PN16

d [mm]	DN [mm]	d [inch]	PN	Code	kg
20	15	½	16	724 701 606	0.220
25	20	¾	16	724 701 607	0.320
32	25	1	16	724 701 608	0.410
40	32	1 ¼	16	724 701 609	0.820
50	40	1 ½	16	724 701 610	1.040
63	50	2	16	724 701 611	1.220
75	65	2 ½	16	724 701 612	1.440
90	80	3	16	724 701 613	1.530
110	100		16	724 700 014	1.840
	100	4	16	724 701 615	1.620
140	125	5	16	724 701 616	2.250
	150	6	16	724 701 617	2.510
* 225	200	8	6	724 701 720	3.000

d [mm]	DN [mm]	d [inch]	D [mm]	D1 [mm]	D2 [mm]	D3 [mm]	H [mm]	AL	SC
20	15	½	95	65	28	14	7	4	M12x55
25	20	¾	105	75	34	14	7	4	M12x60
32	25	1	115	85	42	14	7	4	M12x60
40	32	1 ¼	140	100	51	18	8	4	M16x70
50	40	1 ½	150	110	62	18	8	4	M16x75
63	50	2	165	125	78	18	8	4	M16x80
75	65	2 ½	185	145	92	18	8	4	M16x85
90	80	3	200	160	110	18	8	4	M16x90
110	100		220	180	133	18	8	8	M16x95
	100	4	220	180	138	18	8	8	M16x95
140	125	5	250	210	167	18	8	8	M16x110
	150	6	285	240	200	22	8	8	M20x120
* 225	200	8	340	295	250	22	8	12	M20x150

Backing Flange, Galvanised Steel for Socket Systems

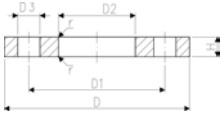

Model:

- Galvanised steel, suitable for laying underground
- Connecting dimension: ANSI/ASME B 16.5 class 150, ASTM D 4024, BS 1560, BS EN 1759
- Bolt circle Class 150

AL: number of holes

d [mm]	DN [mm]	d [inch]	PN	Code	kg
20	15	1/2	16	724 701 806	0.241
25	20	3/4	16	724 701 807	0.271
32	25	1	16	724 701 808	0.359
40	32	1 1/4	16	724 701 809	0.480
50	40	1 1/2	16	724 701 810	0.396
63	50	2	16	724 701 811	0.677
75	65	2 1/2	16	724 701 812	1.200
90	80	3	16	724 701 813	0.999
110	100		16	724 703 814	2.011
	100	4	16	724 701 815	1.890
140	125	5	16	724 701 816	2.000
	150	6	16	724 701 817	1.917
225	200	8	6	724 701 820	3.160

d [mm]	DN [mm]	d [inch]	D [mm]	D1 [mm]	D2 [mm]	D3 [mm]	H [mm]	AL	SC
20	15	1/2	89	60	28	16	7	4	M12x55
25	20	3/4	98	70	34	16	7	4	M12x60
32	25	1	108	79	42	16	7	4	M12x60
40	32	1 1/4	117	89	51	16	8	4	M12x70
50	40	1 1/2	127	98	62	16	8	4	M12x75
63	50	2	152	121	78	19	8	4	M16x80
75	65	2 1/2	178	140	92	19	8	4	M16x85
90	80	3	190	152	110	19	8	4	M16x90
110	100		229	190	133	19	8	8	M16x95
	100	4	229	190	138	19	8	8	M16x95
140	125	5	254	216	167	22	8	8	M20x120
	150	6	279	241	200	22	8	8	M20x120
225	200	8	343	298	250	22	8	8	M20x150

Backing flange PVC-U metric**Model:**

- For socket systems
- Connecting dimension: ISO 7005, EN 1092, BS 4504, DIN 2501
- Maximum medium- or ambient temperature 45 °C
- **Bolt circle PN 10**

¹ Connecting dimension: ISO 2536, bolt circle acc. DN125, suitable for flange adaptor d125/DN100

² Connecting dimension: ISO 2536, bolt circle acc. DN225, suitable for flange adaptor d250/DN250

AL: number of holes

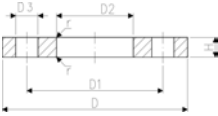

d [mm]	DN [mm]	Inch	PN	Code	kg
16	10	3/8	10	721 700 005	0.054
20	15	1/2	10	721 700 006	0.069
25	20	3/4	10	721 700 007	0.088
32	25	1	10	721 700 008	0.132
40	32	1 1/4	10	721 700 009	0.198
50	40	1 1/2	10	721 700 010	0.247
63	50	2	10	721 700 011	0.312
75	65	2 1/2	10	721 700 012	0.376
90	80	3	10	721 700 013	0.464
110	100	4	10	721 700 014	0.543
¹ 125	125	4 1/2	10	721 700 015	0.904
140	125	5	10	721 700 016	0.765
200	200	7	10	721 700 019	1.669
225	200	8	10	721 700 020	1.377
250	250	9	6	721 700 021	2.353
² 250	225	9	6	721 700 136	1.800
280	250	10	6	721 700 137	1.746
315	300	12	6	721 700 138	2.349
355	350	14	6	721 700 139	3.485
400	400	16	6	721 700 140	4.526

d [mm]	D [mm]	D1 [mm]	D2 [mm]	D3 [mm]	H [mm]	r [mm]	AL	SC
16	90	60	23	14	10	1	4	M12
20	95	65	28	14	11	1	4	M12
25	105	75	34	14	12	2	4	M12
32	115	85	42	14	14	2	4	M12
40	140	100	51	18	15	2	4	M16
50	150	110	62	18	16	2	4	M16
63	165	125	78	18	18	3	4	M16
75	185	145	92	18	19	3	4	M16
90	200	160	110	18	20	3	8	M16
110	220	180	133	18	22	3	8	M16
¹ 125	250	210	150	18	26	5	8	M16
140	250	210	167	18	26	4	8	M16
200	340	295	226	22	32	4	8	M20
225	340	295	250	22	32	4	8	M20
250	395	350	277	22	36	4	12	M20
² 250	370	325	277	22	36	4	8	M20
280	395	350	310	22	36	4	12	M20

table continued next page

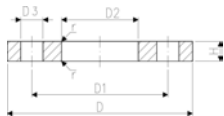

d [mm]	D [mm]	D1 [mm]	D2 [mm]	D3 [mm]	H [mm]	r [mm]	AL	SC	
315	445	400	348	22	36	4	12	M20	
355	505	460	388	22	38	5	16	M20	
400	565	515	442	26	42	5	16	M24	

21 70 22



Backing Flanges, PVC-U Inch ASTM / ANSI

Model:

- For socket systems
- For Flange Adaptors BS/ANSI
- Connecting dimension: ANSI/ASME B 16.5 class 150, ASTM D 4024, BS 1560, BS EN 1759
- **Bolt circle class 150**

* Only for use with metric flange adaptors

AL: number of holes

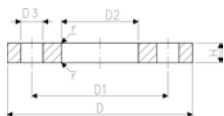

Inch	DN [mm]	d [mm]	PN	Code	kg	kg/m	
½	15		10	721 702 206	0.068	0.068	
¾	20		10	721 702 207	0.090	0.090	
1	25		10	721 702 208	0.128	0.128	
1 ¼	32		10	721 702 209	0.203	0.203	
1 ½	40		10	721 702 210	0.238	0.238	
2	50		10	721 702 211	0.302	0.302	
2 ½	65		10	721 702 212	0.369	0.369	
3	80		10	721 702 213	0.509	0.509	
4	100		10	721 702 214	0.516	0.516	
* 4	100	110	10	161 483 180	0.538	0.538	
5	125		10	721 702 216	0.737	0.737	
6	150		10	721 702 217	1.910	1.910	
8	200		10	721 702 220	1.360	1.360	

Inch	DN [mm]	d [mm]	D [mm]	D1 [mm]	D2 [mm]	D3 [mm]	H [mm]	r [mm]	AL	
½	15		95	60	28	16	11	1	4	
¾	20		105	70	34	16	12	2	4	
1	25		115	79	42	16	14	2	4	
1 ¼	32		140	89	51	16	15	2	4	
1 ½	40		150	98	62	16	16	2	4	
2	50		165	121	78	19	18	3	4	
2 ½	65		185	140	92	19	19	3	4	
3	80		200	152	110	19	20	3	4	
4	100		220	190	138	19	22	3	8	
* 4	100	110	220	190	133	19	22	3	8	
5	125		250	216	167	22	26	4	8	
6	150		285	241	200	22	28	4	8	
8	200		340	298	250	22	32	4	8	

27 70 04
27 70 05

Backing Flanges, PP-V For socket systems metric

Model:

- Modern full-plastic flange PP-GF (30 % glass-fibre reinforced)
- With V-groove which applies force evenly on collar
- With integrated bolt retainers as an assembly aid
- UV-resistant. Applicable for outside applications
- Connecting dimension: ISO 7005, EN 1092, BS 4504, DIN 2501
- **Bolt circle PN 10**

AL: number of holes

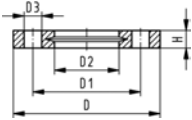

d [mm]	Inch	DN [mm]	PN	Code	LVI	kg
20		15	16	727 700 406	183 38 09	0.093
25		20	16	727 700 407	183 38 10	0.120
32		25	16	727 700 408	183 38 11	0.151
40		32	16	727 700 409	183 38 12	0.244
50		40	16	727 700 410	183 38 13	0.297
63		50	16	727 700 411	183 38 14	0.362
75		65	16	727 700 412	183 38 15	0.487
90		80	16	727 700 413	183 38 16	0.550
110		100	16	727 700 414	183 38 17	0.640
140		125	16	727 700 416	183 38 18	0.781
160	6	150	16	727 700 417	183 38 19	1.050
200		200	16	727 700 419	183 38 20	1.629
225	8	200	16	727 700 420	183 38 21	1.400
250		250	16	727 700 421	183 38 22	2.229
280		250	16	727 700 422	183 38 23	1.651
315		300	16	727 700 423	183 38 24	2.461

d [mm]	D [mm]	D1 [mm]	D2 [mm]	D3 [mm]	H [mm]	AL	SC
20	95	65.0	28	14	16	4	M12
25	105	75.0	34	14	17	4	M12
32	115	85.0	42	14	18	4	M12
40	140	100.0	51	18	20	4	M16
50	150	110.0	62	18	22	4	M16
63	165	125.0	78	18	24	4	M16
75	185	145.0	92	18	26	4	M16
90	200	160.0	110	18	27	8	M16
110	220	180.0	133	18	28	8	M16
140	250	210.0	167	18	30	8	M16
160	285	241.0	190	22	32	8	M20
200	340	296.0	226	22	34	8	M20
225	340	295.0	250	22	34	8	M20
250	395	350.0	277	22	38	12	M20
280	395	350.0	310	22	38	12	M20
315	445	400.0	348	22	42	12	M20

27 70 14
27 70 15

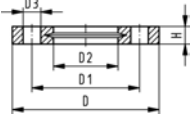

Backing Flanges, PP-V For socket systems Inch ANSI

Model:

- Modern full-plastic flange PP-GF (30 % glass-fibre reinforced)
- With V-groove which applies force evenly on collar
- With integrated bolt-fixing as an assembly aid
- UV-resistant. Applicable for outside applications
- Connecting dimension: ANSI/ASME B 16.5 class 150, ASTM D 4024, BS 1560, BS EN 1759
- **Bolt circle class 150**
- DN100 and DN150: only for use with original metric flange adaptors

1) Suitable for socket- and butt fusion systems (no pictograph on flange)

AL: number of holes

Inch	DN [mm]	PN	Code	LVI	kg	kg/m
1 1/2	15	16	727 701 406	183 38 19	0.091	0.091
3/4	20	16	727 701 407		0.120	0.120
1	25	16	727 701 408		0.147	0.147
1 1/4	32	16	727 701 409		0.246	0.246
1 1/2	40	16	727 701 410		0.299	0.299
2	50	16	727 701 411		0.361	0.361
2 1/2	65	16	727 701 412		0.492	0.492
3	80	16	727 701 413		0.605	0.605
4	100	16	727 701 414		0.704	0.704
6	150	16	727 700 417		1.050	1.050
10	250	16	727 701 422		1.838	1.838
12	300	16	727 701 423		3.482	3.482

Inch	D [mm]	D1 [mm]	D2 [mm]	D3 [mm]	H [mm]	AL	SC
1 1/2	95	60	28	16	16	4	M12
3/4	105	70	34	16	17	4	M12
1	115	79	42	16	18	4	M12
1 1/4	140	89	51	16	20	4	M16
1 1/2	150	98	62	16	22	4	M16
2	165	121	78	19	24	4	M16
2 1/2	185	140	92	19	26	4	M16
3	200	152	110	19	27	4	M16
4	229	190	133	19	28	8	M16
6	285		190	22	32	8	M20
10	406	362	310	26	38	12	M20
12	483	432	348	26	42	12	M20

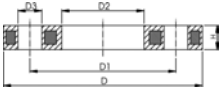

Backing flange PP-Steel For socket systems metric

Model:

- PP-GF (30% glass-fibre reinforced) with steel ring
- UV-resistant. Applicable for outside applications
- Connecting dimension: ISO 7005, EN 1092, BS 4504, DIN 2501
- **Bolt circle PN 10**

¹ Connecting dimension: ISO 2536, bolt circle acc. DN125, suitable for flange adaptor d125/DN100

² Connecting dimension: ISO 2536, bolt circle acc. DN225, suitable for flange adaptor d250/DN250

AL: number of holes

d [mm]	d [inch]	DN [mm]	PN	Code	kg
20		15	16	727 700 206	0.216
25		20	16	727 700 207	0.279
32		25	16	727 700 208	0.429
40		32	16	727 700 209	0.621
50		40	16	727 700 210	0.722
63		50	16	727 700 211	1.084
75		65	16	727 700 212	1.349
90		80	16	727 700 213	1.369
110		100	16	727 700 214	1.522
¹ 125		125	16	727 700 215	2.475
140		125	16	727 700 216	2.033
160		150	16	727 700 217	3.167
200		200	16	727 700 219	6.143
225		200	16	727 700 220	4.510
² 250		225	16	727 700 221	8.340
280		250	16	727 700 222	5.547
315		300	16	727 700 223	6.980
355		350	16	727 700 224	12.465
400		400	16	727 700 225	17.607

d [mm]	D [mm]	D1 [mm]	D2 [mm]	D3 [mm]	H [mm]	AL	SC
20	95	65	28	14	12	4	M12
25	105	75	34	14	12	4	M12
32	115	85	42	14	16	4	M12
40	140	100	51	18	16	4	M16
50	150	110	62	18	20	4	M16
63	165	125	78	18	20	4	M16
75	185	145	92	18	20	4	M16
90	200	160	110	18	20	8	M16
110	220	180	133	18	20	8	M16
¹ 125	250	210	150	18	24	8	M16
140	250	210	167	18	24	8	M16
160	285	240	190	22	24	8	M20
200	340	295	226	22	27	8	M20
225	340	295	250	22	27	8	M20
² 250	395	325	277	22	30	8	M20
280	395	350	310	22	30	12	M20

table continued next page

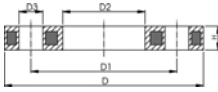

d [mm]	D [mm]	D1 [mm]	D2 [mm]	D3 [mm]	H [mm]	AL	SC
315	445	400	348	22	34	12	M20
355	515	460	388	23	40	16	M20
400	574	515	442	26	40	16	M24

27 70 12



Backing flange PP-Steel For butt fusion systems Inch ANSI

Model:

- Material: PP (30 % glass-fibre reinforced) with steel ring
- UV-resistant. Applicable for outside applications
- Connecting dimension: ANSI/ASME B 16.5 class 150, ASTM D 4024, BS 1560, BS EN 1759
- **Bolt circle class 150**

AL: number of holes

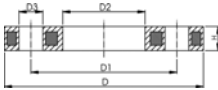
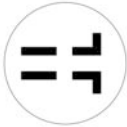

d [inch]	DN [mm]	d [mm]	PN	Code	kg	kg/m
½	15	20	16	727 701 206	0.213	0.213
¾	20	25	16	727 701 207	0.260	0.260
1	25	32	16	727 701 208	0.416	0.416
1 ¼	32	40	16	727 701 209	0.730	0.730
1 ½	40	50	16	727 701 210	0.809	0.809
2	50	63	16	727 701 211	0.866	0.866
2 ½	65	75	16	727 701 212	1.117	1.117
3	80	90	16	727 701 313	1.499	1.499
4	100	110	16	727 701 314	1.739	1.739
6	150	160	16	727 700 317	3.491	3.491
8	200	200	16	727 701 319	5.440	5.440
8	200	225	16	727 701 320	5.621	5.621

d [inch]	D1 [mm]	D2 [mm]	D3 [mm]	D [mm]	H [mm]	AL
½	60	28	16	95	12	4
¾	70	34	16	105	12	4
1	79	42	16	115	16	4
1 ¼	89	51	16	140	16	4
1 ½	98	62	16	150	18	4
2	121	78	19	165	18	4
2 ½	140	92	19	185	18	4
3	152	108	19	200	20	4
4	190	128	19	229	20	8
6	240	178	22	285	24	8
8	298	235	22	340	27	8
8	298	238	22	340	27	8

21 70 12

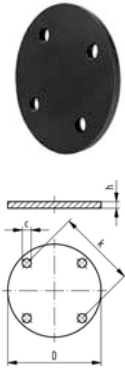

**Blanking flange PVC-U
Drilled to BS 10**

d [inch]	PN	Code	kg	kg/m	c [mm]	D [mm]	h [mm]	holes
1/2	15	721 701 206	0.080	0.080	15	95	10	4
3/4	15	721 701 207	0.110	0.110	15	105	10	4
1	15	721 701 208	0.120	0.120	15	115	10	4
1 1/4	15	721 701 209	0.190	0.190	16	140	10	4
1 1/2	15	721 701 210	0.240	0.240	16	150	10	4
2	15	721 701 211	0.370	0.370	18	165	10	4
3	15	721 701 213	0.520	0.520	18	200	12	4
4	15	721 701 214	0.730	0.730	18	220	17	8
* 5	15	721 701 215	0.730	0.730	18	220	17	4
6	15	721 701 217	1.700	1.700	22	285	22	8

21 70 11

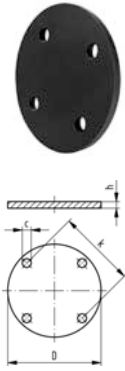

**Blanking flange PVC-U
Drilled to BS 4504 PN10/16**

d [inch]	PN	Code	kg	kg/m	c [mm]	D [mm]	h [mm]	holes
1/2	15	721 701 106	0.080	0.080	14	95	10	4
3/4	15	721 701 107	0.110	0.110	14	105	10	4
1	15	721 701 108	0.139	0.139	14	115	10	4
1 1/4	15	721 701 109	0.190	0.190	18	140	10	4
1 1/2	15	721 701 110	0.240	0.240	18	150	10	4
2	15	721 701 111	0.270	0.270	18	165	10	4
3	15	721 701 113	0.520	0.520	18	200	12	8
4	15	721 701 115	0.950	0.950	18	220	17	8
6	15	721 701 117	1.700	1.700	22	285	22	8

21 70 23

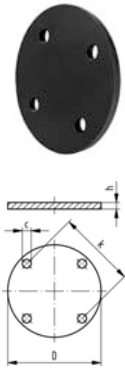

**Blanking flange PVC-U
Drilled to ANSI 16.5 B class 150**

d [inch]	PN	Code	kg	kg/m	c [mm]	D [mm]	h [mm]	holes
1/2	15	721 702 306	0.080	0.080	16	95	10	4
3/4	15	721 702 307			16	105	10	4
1	15	721 702 308	0.120	0.120	16	115	10	4
1 1/4	15	721 702 309			16	140	10	4
1 1/2	15	721 702 310	0.240	0.240	16	150	10	4
2	15	721 702 311			19	165	10	4
3	15	721 702 313	0.520	0.520	19	200	12	4
4	15	721 702 315	0.730	0.730	19	220	17	8
6	15	721 702 317	1.700	1.700	22	285	22	8

21 70 10



Blanking flange PVC-U Undrilled

d [inch]	PN	Code	kg	kg/m	D [mm]	h [mm]
1/2	15	721 701 006	0.080	0.080	95	10
3/4	15	721 701 007	0.110	0.110	105	10
1	15	721 701 008	0.120	0.120	115	10
1 1/4	15	721 701 009	0.202	0.202	140	10
1 1/2	15	721 701 010	0.233	0.233	150	10
2	15	721 701 011	0.370	0.370	165	10
3	15	721 701 013	0.521	0.521	200	12
4	15	721 701 015	0.730	0.730	220	17
6	15	721 701 017	1.700	1.700	285	22

21 70 05



Blanking flange PVC-U Joining face serrated metric

Model:

- Connecting dimension: ISO 7005 PN10, EN 1092 PN10, DIN 2501 PN10
- **d63 to d160: combined joining face (serrated and flat)**
- d250: connecting dimension: ISO 2536
- **Bolt circle PN 10**

* Combined Flange, connecting dimensions EN1092 PN 10 and ANSI B 16.5 Class 150

d20 - d110: bolt hole as long hole version

AL: number of holes

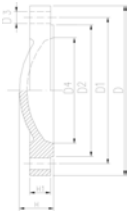

d [mm]	DN [mm]	Inch	PN	Code	kg	kg/m
* 20	15	1/2	10	721 700 506	0.075	0.075
* 25	20	3/4	10	721 700 507	0.097	0.097
* 32	25	1	10	721 700 508	0.145	0.145
* 40	32	1 1/4	10	721 700 509	0.214	0.214
* 50	40	1 1/2	10	721 700 510	0.298	0.298
* 63	50	2	10	721 700 511	0.352	0.352
* 75	65	2 1/2	10	721 700 512	0.538	0.538
* 90	80	3	10	721 700 513	0.679	0.679
* 110	100	4	10	721 700 514	0.870	0.870
* 140	125	5	10	721 700 516	1.286	1.286
* 160	150	6	10	721 700 517	1.761	1.761
225	200	8	10	721 700 520	2.731	2.731
250	250	10	10	721 700 521	3.329	3.329
280	250	10	10	721 700 522	3.769	3.769
315	300	12	6	721 700 523	4.856	4.856
355	350	14	6	721 700 524	6.972	6.972
400	400	16	6	721 700 525	9.125	9.125

d [mm]	D [mm]	D1 [mm]	D1 min. [mm]	D1 max. [mm]	D2 [mm]	D3 [mm]	D4 [mm]	H [mm]	H1 [mm]	AL
* 20	95		61.0	63.0	34	16	15	15	12	4
* 25	105		70.0	73.0	41	16	20	16	13	4
* 32	115		79.0	83.0	50	16	25	19	15	4
* 40	140		91.0	100.0	61	18	34	20	16	4
* 50	150		101.0	110.0	74	18	44	22	17	4

table continued next page

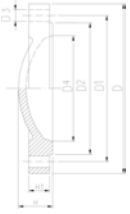

d [mm]	D [mm]	D1 [mm]	D1 min. [mm]	D1 max. [mm]	D2 [mm]	D3 [mm]	D4 [mm]	H [mm]	H1 [mm]	AL	
* 63	165		121.0	124.0	91	19	57	25	20	4	
* 75	185		140.0	145.0	106	22	69	29	21	4	
* 90	200		152.0	160.0	125	22	82	32	22	8	
* 110	220		180.0	191.0	150	24	102	36	24	8	
* 140	250	215			184	23	120	41	28	8	
* 160	285	240			212	23	152	45	30	8	
225	340	295			273	22	213	63	36	8	
250	370	325			303	22	238	63	36	8	
280	395	350			328	22	266	65	36	12	
315	445	400			378	22	299	65	36	12	
355	505	460			430	22	341	67	38	16	
400	565	515			482	26	384	71	42	16	

Seals

EPDM 48 41 00
FPM 49 41 00



O-Ring gasket

Model:

- For unions and adaptor unions
- Hardness approx. 65° Shore
- EPDM minimum temperature -40°C
- FPM minimum temperature -15°C

* for unions PVC-U, PVC-C and ABS: 21 51 01, 21 51 11, 21 53 03, 21 53 08, 21 55 04, 21 55 13, 21 55 18, 23 51 01 and 29 51 01 only

d [mm]	DN [mm]	EPDM Code	FPM Code	kg	kg/m	D [mm]	D1 [mm]	D2 [mm]
10 - 12	8	748 410 004	749 410 004	0.001	0.001	18	12	2.62
16	10	748 410 005	749 410 005	0.001	0.001	21	16	2.62
20	15	748 410 006	749 410 006	0.001	0.001	27	20	3.53
25	20	748 410 007	749 410 007	0.002	0.002	35	28	3.53
32	25	748 410 008	749 410 008	0.002	0.002	40	33	3.53
40	32	748 410 009	749 410 009	0.007	0.007	51	41	5.34
50	40	748 410 010	749 410 010	0.001	0.001	58	47	5.34
63	50	748 410 011	749 410 011	0.010	0.010	70	60	5.34
75	65	748 410 014	749 410 014	0.012	0.012	93	82	5.34
90	80	748 410 015	749 410 015	0.015	0.015	112	101	5.34
110	100	748 410 016	749 410 016	0.031	0.031	134	120	6.99

EPDM 48 40 00
FPM 49 40 00



Flat gasket

Model:

- Hardness approx. 65° Shore
- For adaptor unions

d [mm]	Inch	EPDM Code	FPM Code	kg	kg/m	D [mm]	D1 [mm]	H [mm]
12	¼	748 400 004	-	0.001	0.001	20	13	2
16	⅝	748 400 005	749 400 005	0.001	0.001	24	17	2
20	½	748 400 006	749 400 006	0.003	0.003	30	21	3
25	¾	748 400 007	749 400 007	0.004	0.004	38	27	3
32	1	748 400 008	749 400 008	0.002	0.002	44	32	3
40	1 ¼	748 400 009	749 400 009	0.003	0.003	55	42	3
50	1 ½	748 400 010	749 400 010	0.007	0.007	62	46	3
63	2	748 400 011	749 400 011	0.006	0.006	78	60	3
75	2 ½	748 400 012	749 400 012	0.009	0.009	97	75	3
90	3	748 400 013	749 400 013	0.011	0.011	109	88	3

EPDM 48 40 00
FPM 49 40 00

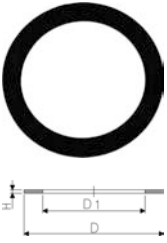

Flat Gaskets

Model:

- For Flange Adaptors 21 79 01/21 80 01
- Hardness: 70° Shore **EPDM**, 75° Shore **FPM**

d [mm]	DN [mm]	Inch	PN	EPDM Code	FPM Code	kg	kg/m
16	10	3/8	10	748 400 014		0.001	0.001
20	15	1/2	10	748 400 015	749 400 015	0.003	0.003
25	20	3/4	10	748 400 016	749 400 016	0.003	0.003
32	25	1	10	748 400 017	749 400 017	0.004	0.004
40	32	1 1/4	10	748 400 018	749 400 018	0.008	0.008
63	50	2	10	748 400 020	749 400 020	0.017	0.017
75	65	2 1/2	10	748 400 021	749 400 021	0.024	0.024
90	80	3	10	748 400 022	749 400 022	0.032	0.032
110	100	4	10	748 400 023		0.033	0.033
140	125	5	10	748 400 025	749 400 025	0.058	0.058
160	150	6	10	748 400 026	749 400 026	0.063	0.063
225	200	8	6	748 400 027	749 400 027	0.103	0.103

d [mm]	D [mm]	D1 [mm]	H [mm]
16	27	16	2
20	32	20	2
25	39	25	2
32	48	32	2
40	59	40	3
63	88	63	3
75	104	75	3
90	123	90	3
110	148	110	4
140	186	140	4
160	211	160	4
225	272	220	5



Flat gasket

Model:

- For all metric GF Flange Adaptors
- Hardness approx. 65° Shore
- Integrated fixation aids from d110
- Centering on the inner diameter of the screw crown

di FA are the suitable inner diameters of flange adaptors

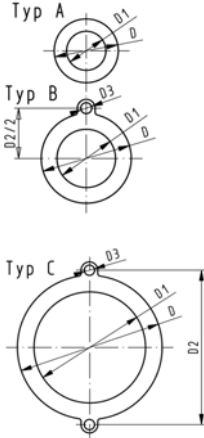

d [mm]	DN [mm]	PN	Type	EPDM Code	kg	kg/m
16	10	10	A	748 400 305	0.004	0.004
20	15	10	A	748 400 306	0.012	0.012
25	20	10	A	748 400 307	0.004	0.004
32	25	10	A	748 400 308	0.008	0.008
40	32	10	A	748 400 309	0.013	0.013
50	40	10	A	748 400 310	0.016	0.016
63	50	10	A	748 400 311	0.018	0.018
75	65	10	A	748 400 312	0.029	0.029
90	80	10	A	748 400 313	0.035	0.035
110	100	10	B	748 400 314	0.051	0.051
125	100	10	B	748 400 315	0.044	0.044
140	125	10	B	748 400 316	0.068	0.068
160 / 180	150	10	B	748 400 317	0.087	0.087
200	200	6	C	748 400 319	0.210	0.210
225	200	6	C	748 400 320	0.132	0.132
250	250	6	C	748 400 321	0.210	0.210
280	250	6	C	748 400 322	0.151	0.151
315	300	6	C	748 400 323	0.237	0.237

d [mm]	DN [mm]	D [mm]	D1 [mm]	D2 [mm]	D3 [mm]	H [mm]	di FA [mm]
16	10	46	16			2	6 - 26
20	15	51	20			2	10 - 30
25	20	61	25			2	15 - 35
32	25	71	32			2	22 - 42
40	32	82	40			3	30 - 50
50	40	92	50			3	40 - 60
63	50	107	63			3	53 - 73
75	65	127	71			3	61 - 81
90	80	142	84			3	74 - 94
110	100	162	104	180	18	4	94 - 114
125	100	162	119	180	18	4	109 - 129
140	125	192	134	210	18	4	124 - 144
160 / 180	150	218	155	241	22	4	145 - 165
200	200	273	195	295	22	5	185 - 205
225	200	273	216	295	22	5	206 - 226
250	250	328	250	350	22	5	240 - 260
280	250	328	273	350	22	5	263 - 283
315	300	378	305	400	22	5	295 - 315

EPDM 48 44 07
FPM 49 44 07

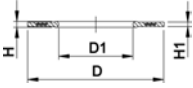

Profile flange gasket metric

Model:

- For all metric GF Flange Adaptors
- Profile Gasket with steel insert (type G-ST-P/K)
- Hardness: 70° Shore **EPDM**, 75° Shore **FPM**
- **EPDM**: approved acc. to DVGW W 270, KTW recommendation
- Centering on the inner diameter of the screw crown
- material steel insert: carbon steel

di FA are the suitable inner diameters of flange adaptors

d [mm]	DN [mm]	PN	EPDM Code	FPM Code	kg
16	10	16	748 440 705	749 440 705	0.012
20	15	16	748 440 706	749 440 706	0.013
25	20	16	748 440 707	749 440 707	0.014
32	25	16	748 440 708	749 440 708	0.019
40	32	16	748 440 709	749 440 709	0.026
50	40	16	748 440 710	749 440 710	0.039
63	50	16	748 440 711	749 440 711	0.050
75	65	16	748 440 712	749 440 712	0.082
90	80	16	748 440 713	749 440 713	0.083
110	100	16	748 440 714	749 440 714	0.127
125	100	16	748 440 715	749 440 715	0.105
140	125	16	748 440 716	749 440 716	0.173
160 / 180	150	16	748 440 717	749 440 717	0.207
200	200	16	748 440 719	749 440 719	0.263
225	200	16	748 440 720	749 440 720	0.255
250	250	16	748 440 721	749 440 721	0.482
280	250	16	748 440 722	749 440 722	0.323
315	300	16	748 440 723	749 440 723	0.549
355	350	16	748 440 724	749 440 724	0.870
400	400	16	748 440 725	749 440 725	1.088
450	500	16	748 440 726	749 440 726	0.718
500	500	16	748 440 727	749 440 727	0.718
560	600	16	748 440 728	749 440 728	0.923
630	600	16	748 440 729	749 440 729	0.923

d [mm]	DN [mm]	D [mm]	D1 [mm]	H [mm]	H1 [mm]	di FA [mm]
16	10	46	16	4	3	6 - 16
20	15	51	20	4	3	10 - 20
25	20	61	22	4	3	12 - 22
32	25	71	28	4	3	18 - 28
40	32	82	40	4	3	30 - 40
50	40	92	46	4	3	36 - 46
63	50	107	58	5	4	48 - 58
75	65	127	69	5	4	59 - 69
90	80	142	84	5	4	73 - 84
110	100	162	104	6	5	94 - 104
125	100	162	123	6	5	113 - 123
140	125	192	137	6	5	127 - 137
160 / 180	150	218	160	8	6	150 - 160
200	200	273	203	8	6	192 - 203
225	200	273	220	8	6	207 - 220

table continued next page

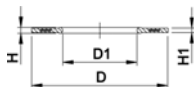

d [mm]	DN [mm]	D [mm]	D1 [mm]	H [mm]	H1 [mm]	di FA [mm]
250	250	328	252	8	6	238 - 252
280	250	328	274	8	6	264 - 274
315	300	378	306	8	6	296 - 306
355	350	438	355	10	7	340 - 355
400	400	489	400	10	7	385 - 400
450	500	594	403	10	7	393 - 403
500	500	594	447	10	7	437 - 447
560	600	695	494	10	7	484 - 494
630	600	695	555	10	7	545 - 555

48 40 10

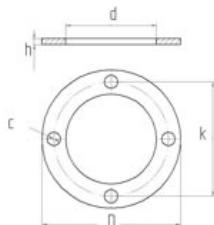

Flat Gaskets for Full Face Flanges EPDM Drilled to BS10 tables D and E

Model:

- For Flange Adaptors
- Hardness approx. 65° Shore

Inch	EPDM Code	kg	kg/m
½	748 401 006	0.031	0.055
¾	748 401 007	0.037	
1	748 401 008	0.037	
1 ¼	748 401 009	0.041	
1 ½	748 401 010	0.055	
2	748 401 011	0.056	
3	748 401 013	0.098	
4	Table E 748 401 014	0.112	
* 4	Table D 748 401 064	0.112	
6	748 401 017	0.162	

Inch	D [mm]	d [mm]	k [mm]	c [mm]	no. of holes	h [mm]
½	95	17	67	15	4	3
¾	105	22	73	15	4	3
1	115	28	83	15	4	3
1 ¼	140	36	88	15	4	3
1 ½	150	45	98	15	4	3
2	165	58	115	18	4	3
3	200	83	146	18	4	3
4	Table E 220	109	178	18	8	3
* 4	Table D 220	109	178	18	4	3
6	285	161	235	22	8	3

48 40 10

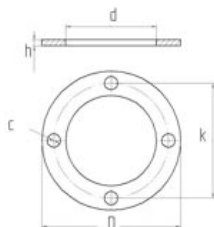

Flat Gaskets for Full Face Flanges Drilled to BS4504 PN10/16

Model:

- For Flange Adaptors
- Hardness approx. 65° Shore

Inch	EPDM Code	FPM Code	kg
½	748 401 006		0.031
¾	748 401 007		0.037
1	748 401 008		0.037

table continued next page

Inch	EPDM Code	FPM Code	kg
1 ¼	748 401 109	749 401 109	0.112
1 ½	748 401 110	749 401 110	
2	748 401 111	749 401 111	
3	748 401 113	749 401 113	
4	748 401 014	749 401 113	
6	748 401 117	749 401 117	

Inch	D [mm]	d [mm]	k [mm]	c [mm]	no. of holes	h [mm]
½	95	17	67	15	4	3
¾	105	22	73	15	4	3
1	115	28	83	15	4	3
1 ¼	140	36	100	18	4	3
1 ½	150	45	110	18	4	3
2	165	58	125	18	4	3
3	200	83	160	18	8	3
4	220	109	178	18	8	3
6	285	161	240	22	8	3

48 40 10

Flat Gaskets for Full Face Flanges Drilled to ANSI B16.5 Class 150

Model:

- For Flange Adaptors
- Hardness approx. 65° Shore

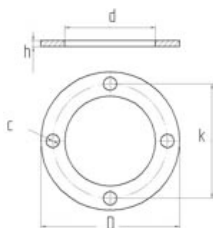

Inch	EPDM Code	FPM Code	kg	kg/m
½	748 401 206	749 401 206	0.050	0.050
¾	748 401 207	749 401 207		
1	748 401 208	749 401 208		
1 ¼	748 401 009			
1 ½	748 401 010			
2	748 401 211	749 401 211		
3	748 401 213	749 401 213	0.110	0.110
4	748 401 214	749 401 214	0.130	0.130

Inch	D [mm]	d [mm]	k [mm]	c [mm]	no. of holes	h [mm]
½	95	17	60	16	4	3
¾	105	22	70	16	4	3
1	115	28	79	16	4	3
1 ¼	140	36	88	15	4	3
1 ½	150	45	98	15	4	3
2	165	58	121	19	4	3
3	200	83	152	19	4	3
4	220	109	190	19	8	3

50 Years of application knowledge

GF CONTAIN-IT Plus PVC-U Double Containment System

Double containment is a safe and cost effective solution for the controlled conveyance of aggressive media.

Contain-IT Plus offers a patented pipe jointing technology unlike any other containment system on the market. The technology allows the separate jointing of the inner and outer pipe so the inner pipe can be joined and pressure tested before the outer is sealed so any leaks in the inner can be found and corrected. This gives a safety and installation advantage over other systems. Fittings are supplied fully contained, whereas pipe is supplied as standard GF inner and outer pipe so no special pipe is required. The pipe is used with centralisers to centre the inner pipe. The fittings offer a completely fixed joint so no further assembly is required for jointing. The inner pipe is joined using standard Tangit or Dytex (for aggressive media) solvent cement procedures, and the outer is joined using either PE electrofusion, or EPDM mechanical couplers. A range of PVC-U grey, PE black, or PVC-U clear outer pipe can be used. Depending on the combination of fittings the Contain-IT Plus system can be offered with a 16 bar inner and 16 bar outer pressure rated system. A range of termination fittings, valves, and leak detection is also available from our GF Signet range.

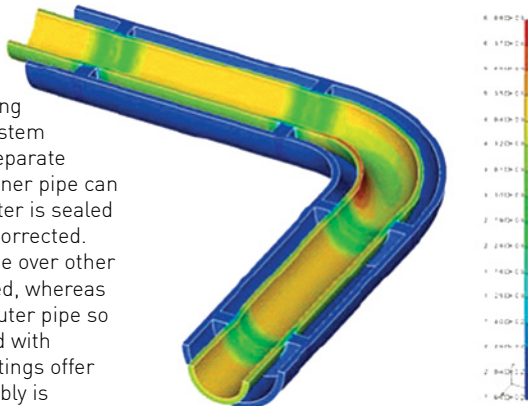

Fields of Application:

- Water treatment
- Chemical industry
- Power generation industry
- Food and beverage production









Product Range:

- Pipes
- Fittings
- Manual valves
- Actuated valves



EN/ISO – d20 – d225mm Inner PVC-U
– d50 – d315mm Outer PVC-U or PE

CONTAIN-IT

		Page
	Outer pipes and accessories	232
	ELGEF Plus electrofusion fittings	234
	Outer pipes and accessories	236
	Leak detection	238
	Adaptor fittings	239
	POLY16 Plus CLAMP SADDLES	240
	Leak detection	244
	PVC-U/PE100 Connection of inner pipe by solvent cementing	246
	Inner pipe and connection elements PVC-U	251

Outer pipes and accessories

Containment pipes PVC-U

Model:

- Material: PVC-U, Polyvinylchloride unplasticised DIN 8061
- Colour: RAL 7011 - dark-grey
- Dimension: acc. DIN 8062
- Pipe length: 5m, with plain ends

Attention:

- Pressure rating for containment pipe. For using the EPDM coupler the pressure rating for containment pipe is only 1 bar.

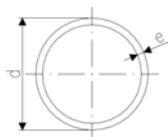

d [mm]	PN	Code	kg	e [mm]
50	16	161 017 110	0.809	3.7
63	16	161 017 111	1.290	4.7
75	10	161 017 087	1.220	3.6
90	10	161 017 088	1.750	4.3
110	10	161 017 089	2.610	5.3
125	6	161 017 065	2.130	3.7
140	6	161 017 066	2.650	4.1
160	6	161 017 067	3.440	4.7
180	6	161 017 068	4.370	5.3
200	6	161 017 069	5.370	5.9
225	6	161 017 070	6.760	6.6
280	4	161 017 047	7.110	5.5
315	4	161 017 048	9.020	6.2

Containment pipes PVC-U transparent

Model:

- Material: PVC-U, Polyvinylchloride unplasticised DIN 8061
- Colour: transparent
- Dimension: acc. DIN 8062
- Pipe length: 5m, with plain ends

Attention:

- Pressure rating for containment pipe. For using the EPDM coupler the pressure rating for containment pipe is only 1 bar.

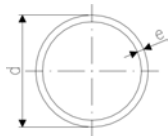

d [mm]	PN	Code	kg	e [mm]	Description
50	16	192 017 110	0.809	3.7	
63	16	192 017 111	1.290	4.7	
75	10	192 017 087	1.220	3.6	
90	10	192 017 088	1.750	4.3	
110	10	192 017 089	2.610	5.3	
125	4	192 017 040	1.480	2.5	
140	4	192 017 041	1.840	2.8	
160	6	192 017 080	3.440	4.7	
180	6	-		8.6	on request
200	4	192 017 044	3.700	4.0	
225	4	192 017 045	4.700	4.5	
280	4	192 017 047	7.600	5.5	
315	4	-		6.2	on request

93 01 71

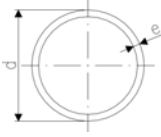

Containment pipes PE100 S5/SDR11

Model:

- Material: PE 100, Polyethylene
- Colour: RAL 9011 graphite black
- Dimension: DIN 8074
- Pipe length: 5m, with plain ends

d [mm]	PN	Code	kg	e [mm]
50	16	193 017 160	0.673	4,6
63	16	193 017 161	1.060	5,8
75	16	193 017 162	1.480	6,8

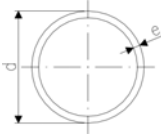

Containment pipes PE100 S8,3/SDR17,6

Model:

- Material: PE 100, Polyethylene
- Colour: RAL 9011 graphite black
- Dimension: DIN 8074
- Pipe length: 5m, with plain ends

d [mm]	PN	Code	kg	e [mm]
90	10	193 017 113	1.400	5,1
110	10	193 017 114	2.100	6,3
125	10	193 017 115	2.690	7,1
140	10	193 017 116	3.370	8,0
160	10	193 017 117	4.400	9,1
180	10	193 017 118	5.540	10,2
200	10	193 017 119	6.860	11,4
225	10	193 017 120	8.640	12,8
250	10	193 017 121	10.700	14,2
280	10	193 017 122	13.300	15,9
315	10	193 017 123	16.900	17,9

ELGEF Plus electrofusion fittings

53 91 16

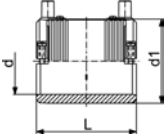

Coupler With integral pipe fixation

- PE 100 SDR 11 (ISO S5)
- 10 bar Gas / 16 bar Water
- 4 mm pin connectors
- Limited path fusion indicators
- Removable centre stop

d [mm]	Code	LVI	kg	d1 [mm]	L [mm]
50	753 911 610	183 32 76	0.131	66	88
63	753 911 611	183 32 77	0.194	81	96

53 91 16

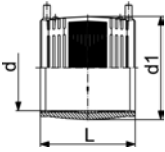

Coupler

- PE 100 SDR 11 (ISO S5)
- 10 bar Gas / 16 bar Water
- 4 mm pin connectors
- Limited path fusion indicators
- Removable centre stop up to d160

d [mm]	Code	LVI	kg	d1 [mm]	L [mm]
75	753 911 612	183 32 78	0.282	96	110
90	753 911 613	183 32 79	0.406	113	125
110	753 911 614	183 32 80	0.692	138	145
125	753 911 615	183 32 81	0.777	154	156
140	753 911 616	183 32 82	0.963	172	166

53 91 18

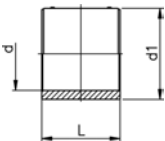

Coupler

- PE 100 SDR 17 (ISO S8)
- 5 bar Gas / 10 bar Water
- 4 mm pin connectors
- Limited path fusion indicators
- d160 with removable centre stop

d [mm]	Code	LVI	kg	d1 [mm]	L [mm]
160	753 911 817	183 32 94	1.017	186	180
180	753 911 818	183 32 95	1.450	213	192
200	753 911 819	183 32 96	1.726	233	206
225	753 911 820	183 32 97	2.545	261	225
250	753 911 821	183 32 98	4.616	304	248
280	753 911 822	183 32 99	5.606	304	252
315	753 911 823	183 33 00	8.186	382	267



Coupler EPDM

- Connection for outer pipe
- leak tight up to 1 bar
- Not to be applied when there are axial forces

d [mm]	PN	Code	kg	d1 [mm]	L [mm]
50	1	700 238 444	0.217	66	85
63	1	700 238 445	0.260	80	85
75	1	700 238 446	0.307	93	85
90	1	700 238 447	0.352	110	85
110	1	700 238 448	0.835	130	125
125	1	700 238 449	0.948	145	125
140	1	700 238 450	1.031	160	125
160	1	700 238 451	1.129	180	125
180	1	700 238 452	1.215	200	125
200	1	700 238 453	1.387	220	125
225	1	700 238 454	1.541	245	125
280	1	700 238 456	2.250	300	150
315	1	700 238 457	2.462	335	150

Outer pipes and accessories

21 91 01

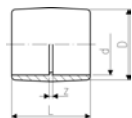

Socket equal PVC-U metric

* See comments regarding PN in Georg Fischer Piping Systems Planning Fundamentals

d [mm]	d [inch]	PN	Code	kg	z [mm]	D [mm]	L [mm]
50		16	721 910 110	0.063	3	58	65
63		16	721 910 111	0.119	3	73	79
75	2 ½	16	721 910 112	0.188	4	87	92
90		16	721 910 113	0.328	5	105	107
110		16	721 910 114	0.554	6	128	128
125		16	721 910 115	0.825	7	142	145
140	5	16	721 910 116	1.118	7	162	159
160		16	721 910 117	1.540	8	183	180
200		10	721 910 119	2.559	9	221	221
225		10	721 910 120	3.519	10	253	248
280		10	721 910 122	8.312	16	321	314
315		6	721 910 123	8.300	16	356	348

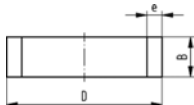

Snap ring PE

- For closing the gap in the outer pipe

d [mm]	Code	kg	e [mm]	B [mm]
50	700 238 424	0.021	4.6	30
63	700 238 425	0.030	5.8	30
75	700 238 426	0.038	6.9	30
90	700 238 427	0.040	5.1	30
110	700 238 428	0.062	6.3	30
125	700 238 429	0.079	7.1	30
140	700 238 430	0.101	8.0	30
160	700 238 431	0.129	9.1	30
180	700 238 432	0.161	10.2	30
200	700 238 433	0.204	11.4	30
225	700 238 434	0.251	12.8	30
280	700 238 436	0.396	15.9	30
315	700 238 437	0.498	17.9	30

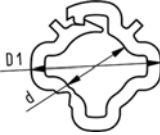

Spacer PP-H

- To center the medium pipe within the outer pipe
- To clamp upon the medium pipe

d [mm]	D1 [mm]	Code	kg	B [mm]
20	38	700 238 060	0.006	15
25	38	700 238 061	0.008	20
32	48	700 238 062	0.011	20
40	57	700 238 043	0.019	25
50	76	700 238 064	0.025	25
63	94	700 238 065	0.037	25
75	104	700 238 046	0.047	30
90	118	700 238 047	0.059	30
110	138	700 238 068	0.080	35
125	152	700 238 049	0.100	35
140	173	700 238 070	0.125	35
160	195	700 238 071	0.141	35
200	238	700 238 053	0.255	40
225	267	700 238 054	0.258	40



Foil roll PE

- To fix and seal of pre-assembled ELGEF Coupler

	Code	kg
Roll of PE-stretch foil	799 198 041	0.341

Leak detection

Branch saddle PE100

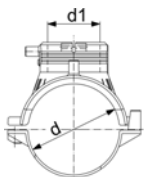

L = length / Länge

d [mm]	d1 [mm]	Code	LVI	kg	L [mm]
63	63	193 131 037	183 34 21	0.325	165
75	63	193 131 047	183 34 22	0.455	165
90	63	193 131 057	183 34 23	0.412	165
110	63	193 131 067	183 34 24	0.471	165
125	63	193 131 077	183 34 25	0.502	165
140	63	193 131 087	183 34 26	0.523	165
160	63	193 131 097	183 34 27	0.503	165
180	63	193 131 107	183 34 28	0.600	165
200	63	193 131 117	183 34 29	0.634	165
225	63	193 131 127	183 34 30	0.618	165
** 280	63	193 131 147	183 34 32	0.359	165
** 315 - 355	63	193 131 157	183 40 46	0.373	165

Adaptor fittings

21 91 07

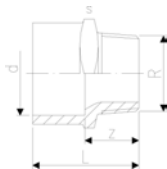

Adaptor bush equal PVC-U metric R

Model:

- With solvent cement socket metric and taper male thread R
- Do not use thread sealing pastes that are harmful to PVC-U
- Install with low mechanical stress and avoid large cyclic temperature changes

d [mm]	R [inch]	PN	d [inch]	Code	kg	z [mm]	L [mm]	s [mm]
16	3/8	16	3/8	721 910 705	0.011	20	34	27
20	1/2	16	1/2	721 910 706	0.018	24	40	32
25	3/4	16	3/4	721 910 707	0.025	25	44	36
32	1	16	1	721 910 708	0.039	28	50	46
40	1 1/4	16	1 1/4	721 910 709	0.061	31	57	55
50	1 1/2	16	1 1/2	721 910 710	0.092	32	63	65
63	2	16	2	721 910 711	0.161	38	76	80
75	2 1/2	10	2 1/2	721 910 712	0.227	42	86	90
90	3	10	3	721 910 713	0.389	46	97	110
110	4	10	4	721 910 714	0.572	53	114	130

POLY16 Plus CLAMP SADDLES

27 62 70

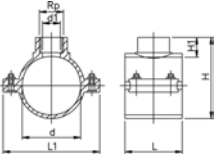

654X - Blue clamp saddles with stainless steel reinforcement ring, flat gasket and stainless steel bolts and nuts (PN16-PN10)

- water PN16-10
- suitable for PE and PVC pipes
- material: PP
- female thread: ISO 7 (parallel)
- gasket: O-ring with flat lip (NBR)
- reinforcement ring: stainless steel AISI430
- bolts and nuts : stainless steel
- colour: blue
- B= N° of bolts
- M= bolt type
- (*) with O-ring gasket

d [mm]	Rp [inch]	PN	B	M	Code	kg
* 20	1/2	16	2	M8X40	727 627 001	0.121
* 25	1/2	16	2	M8X30	727 627 011	0.110
* 25	3/4	16	2	M8X30	727 627 012	0.123
* 32	1/2	16	2	M8X30	727 627 021	0.103
* 32	3/4	16	2	M8X30	727 627 022	0.115
* 32	1	16	2	M8X40	727 627 023	0.164
40	1/2	16	2	M8X40	727 627 031	0.137
40	3/4	16	2	M8X40	727 627 032	0.148
40	1	16	2	M8X40	727 627 033	0.155
50	1/2	16	4	M8X40	727 627 041	0.200
50	3/4	16	4	M8X40	727 627 042	0.213
50	1	16	4	M8X40	727 627 043	0.221
50	1 1/4	16	4	M8X40	727 627 044	0.225
63	1/2	16	4	M8X40	727 627 051	0.216
63	3/4	16	4	M8X40	727 627 052	0.226
63	1	16	4	M8X40	727 627 053	0.232
63	1 1/4	16	4	M8X40	727 627 054	0.272
63	1 1/2	16	4	M8X40	727 627 055	0.279
75	1/2	16	4	M8X60	727 627 061	0.364
75	3/4	16	4	M8X60	727 627 062	0.376
75	1	16	4	M8X60	727 627 063	0.384
75	1 1/4	16	4	M8X60	727 627 064	0.421
75	1 1/2	16	4	M8X60	727 627 065	0.428
75	2	16	4	M8X60	727 627 066	0.437
90	1/2	16	4	M8X60	727 627 071	0.412
90	3/4	16	4	M8X60	727 627 072	0.421
90	1	16	4	M8X60	727 627 073	0.432
90	1 1/4	16	4	M8X60	727 627 074	0.472
90	1 1/2	16	4	M8X60	727 627 075	0.474
90	2	16	4	M8X60	727 627 076	0.481
110	1/2	16	6	M8X50	727 627 081	0.511
110	3/4	16	6	M8X50	727 627 082	0.523
110	1	16	6	M8X50	727 627 083	0.533
110	1 1/4	16	6	M8X50	727 627 084	0.565

table continued next page

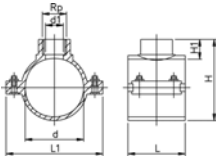

d [mm]	Rp [inch]	PN	B	M	Code	kg
110	1 1/2	16	6	M8X50	727 627 085	0.566
110	2	16	6	M8X50	727 627 086	0.570
110	3	6	6	M8X70	727 627 087	1.108
125	1/2	16	6	M8X50	727 627 091	0.578
125	3/4	16	6	M8X50	727 627 092	0.590
125	1	16	6	M8X50	727 627 093	0.592
125	1 1/4	16	6	M8X50	727 627 094	0.629
125	1 1/2	16	6	M8X50	727 627 095	0.627
125	2	16	6	M8X50	727 627 096	0.640
125	3	6	6	M8X70	727 627 097	1.009
125	4	6	6	M8X70	727 627 098	1.051
140	1/2	16	6	M8X70	727 627 101	0.830
140	3/4	16	6	M8X70	727 627 102	0.843
140	1	16	6	M8X70	727 627 103	0.849
140	1 1/4	16	6	M8X70	727 627 104	0.880
140	1 1/2	16	6	M8X70	727 627 105	0.892
140	2	16	6	M8X70	727 627 106	0.898
140	3	10	6	M8X70	727 627 107	1.132
140	4	10	6	M8X70	727 627 108	1.196
160	1/2	16	6	M8X70	727 627 111	0.899
160	3/4	16	6	M8X70	727 627 112	0.908
160	1	16	6	M8X70	727 627 113	0.917
160	1 1/4	16	6	M8X70	727 627 114	0.950
160	1 1/2	16	6	M8X70	727 627 115	0.954
160	2	16	6	M8X70	727 627 116	0.956
160	3	10	6	M8X70	727 627 117	1.185
160	4	10	6	M8X70	727 627 118	1.262
* 180	1	10	6	M10x80	727 627 123	1.980
* 180	1 1/4	10	6	M10x80	727 627 124	2.013
* 180	1 1/2	10	6	M10x80	727 627 125	2.007
* 180	2	10	6	M10x80	727 627 126	2.018
* 180	3	10	6	M10x80	727 627 127	2.043
* 180	4	10	6	M10x80	727 627 128	2.092
* 200	1 1/2	10	6	M10x80	727 627 135	1.966
* 200	2	10	6	M10x80	727 627 136	1.946
* 200	3	10	6	M10x80	727 627 137	1.980
* 200	4	10	6	M10x80	727 627 138	2.020
* 225	1 1/2	10	6	M10x80	727 627 145	2.049
* 225	2	10	6	M10x80	727 627 146	2.050
* 225	3	10	6	M10x80	727 627 147	2.150
* 225	4	10	6	M10x80	727 627 148	2.184
* 250	2	10	6	M10x80	727 627 156	2.472
* 250	3	10	6	M10x80	727 627 157	2.466
* 250	4	10	6	M10x80	727 627 158	2.478
280	2	10	6	M10x160	727 627 166	3.440
* 280	3	10	6	M10x160	727 627 167	3.543
* 280	4	10	6	M10x160	727 627 168	3.585
315	2	10	6	M10x110	727 627 176	4.156
* 315	3	10	6	M10x110	727 627 177	4.267
* 315	4	10	6	M10x110	727 627 178	4.279

table continued next page

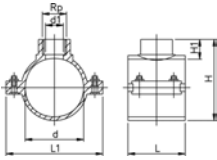

d [mm]	Rp [inch]	d1 [mm]	L [mm]	L1 [mm]	H [mm]	H1 [mm]
* 20	1/2	12	46	77	59	26
* 25	1/2	13	49	79	58	15
* 25	3/4	13	49	79	58	15
* 32	1/2	14	49	79	62	20
* 32	3/4	14	49	79	62	20
* 32	1	14	62	87	70	20
40	1/2	21	62	86	71	20
40	3/4	21	62	86	71	20
40	1	21	62	86	70	19
50	1/2	21	62	86	82	20
50	3/4	21	62	86	82	20
50	1	21	62	86	82	20
50	1 1/4	21	62	86	82	20
63	1/2	18	62	101	96	21
63	3/4	24	62	101	96	21
63	1	31	62	101	96	21
63	1 1/4	31	62	101	96	21
63	1 1/2	31	62	101	96	21
75	1/2	16	79	123	102	14
75	3/4	21	79	123	104	16
75	1	27	79	123	107	19
75	1 1/4	35	79	123	109	21
75	1 1/2	42	79	123	109	21
75	2	53	79	123	112	24
90	1/2	16	87	138	116	14
90	3/4	21	87	138	118	16
90	1	27	87	138	121	19
90	1 1/4	35	87	138	123	21
90	1 1/2	42	87	138	123	21
90	2	53	87	138	126	24
110	1/2	15	99	152	150	23
110	3/4	20	99	152	150	23
110	1	26	99	152	150	23
110	1 1/4	35	99	152	150	23
110	1 1/2	41	99	152	150	23
110	2	51	99	152	150	23
110	3	85	99	152	150	23
125	1/2	15	101	166	169	24
125	3/4	20	101	166	169	24
125	1	26	101	166	169	24
125	1 1/4	35	101	166	168	23
125	1 1/2	41	101	166	168	23
125	2	50	101	166	168	23
125	3	85	139	178	180	37
125	4	90	139	178	181	38
140	1/2	18	114	207	191	25
140	3/4	24	114	207	191	25
140	1	30	114	207	191	25
140	1 1/4	38	114	207	191	25
140	1 1/2	45	114	207	191	24
140	2	50	114	207	191	24

table continued next page

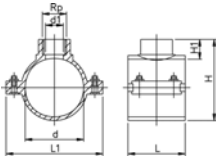

d [mm]	Rp [inch]	d1 [mm]	L [mm]	L1 [mm]	H [mm]	H1 [mm]
140	3	85	142	208	201	38
140	4	90	142	208	201	38
160	1/2	18	114	226	215	24
160	3/4	24	114	226	215	24
160	1	30	114	226	215	24
160	1 1/4	37	114	226	215	24
160	1 1/2	45	114	226	215	24
160	2	51	114	226	215	24
160	3	84	142	228	222	24
160	4	90	142	228	222	24
* 180	1	30	169	262	265	38
* 180	1 1/4	36	169	262	265	38
* 180	1 1/2	42	169	262	265	38
* 180	2	54	169	262	265	38
* 180	3	84	169	262	265	38
* 180	4	108	169	262	265	38
* 200	1 1/2	45	169	262	265	38
* 200	2	54	169	262	265	38
* 200	3	85	169	262	265	38
* 200	4	103	169	262	267	40
* 225	1 1/2	45	145	287	287	26
* 225	2	51	145	287	287	26
* 225	3	85	174	287	295	37
* 225	4	103	174	287	295	38
* 250	2	55	178	310	314	38
* 250	3	85	178	310	314	38
* 250	4	103	178	310	314	38
280	2	51	179	335	326	31
* 280	3	78	179	335	338	41
* 280	4	98	179	335	338	46
315	2	51	246	390	350	31
* 315	3	78	246	390	363	41
* 315	4	98	246	390	363	46

Leak detection

Ball valve type 546 PVC-U With solvent cement spigots metric

Model:

- For easy installation and removal
- Ball seals PTFE
- Without mounting inserts
- z-dimension, valve end and union nut are **not compatible** with type 346 (DN10/15-50) resp. type 370 (DN65-100)

Option:

- Individual configuration of the valve (see diagram)
- Multifunctional module with integrated limit switches
- Pneumatic or electric actuators from +GF+

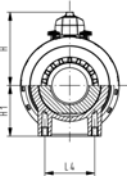
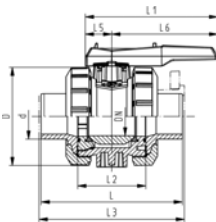
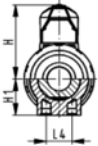
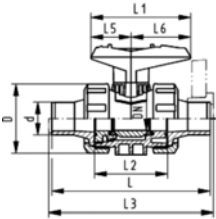

d [mm]	DN [mm]	PN	kv-value ($\Delta p=1$ bar) [l/min]	EPDM Code	kg
20	15	16	185	161 546 042	0.155

d [mm]	D [mm]	H [mm]	H1 [mm]	L [mm]	L1 [mm]	L2 [mm]	L3 [mm]	L4 [mm]	L5 [mm]	L6 [mm]
20	50	57	27	124	77	56	130	25	32	45



Monitoring pipe PVC-U transparent

d [mm]	Code	kg	L [mm]	D [mm]	
20	700 244 652	0.033	110	38	

PVC-U/PE100

Connection of inner pipe by solvent cementing

Elbow 90° PVC-U/PE100

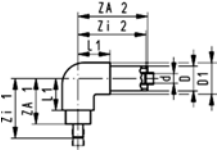

d [mm]	D [mm]	PN [bar]	PVC-U Tangit / PE Code	PVC-U Dytex / PE Code	kg
20	50	16 / 16	721 104 106	721 104 156	0.455
25	50	16 / 16	721 104 107	721 104 157	0.499
32	63	16 / 16	721 104 108	721 104 158	0.805
40	75	16 / 16	721 104 109	721 104 159	1.403
50	90	16 / 10	721 104 110	721 104 160	1.924
63	110	16 / 10	721 104 111	721 104 161	3.210
75	125	16 / 10	721 104 112	721 104 162	4.718
90	140	16 / 10	721 104 113	721 104 163	8.358
110	160	16 / 10	721 104 114	721 104 164	9.204
125	180	16 / 10	721 104 115		9.800
140	200	16 / 10	721 104 116		15.600
160	225	16 / 10	721 104 117		19.700
200	280	10 / 10	721 104 119		24.200
225	315	10 / 10	721 104 120		30.600

d [mm]	ZA 1 [mm]	ZA 2 [mm]	L1 [mm]	Zi 1 [mm]	Zi 2 [mm]	D1 [mm]
20	105	175	71	139	174	66
25	105	175	71	142	171	66
32	120	190	81	160	183	81
40	145	225	94	189	214	97
50	170	260	110	219	244	113
63	210	310	132	266	287	136
75	225	330	142	288	301	151
90	250	360	178	321	324	196
110	260	375	178	342	329	196
125	280	400	195	371	346	219
140	285	405	170	383	344	250
160	335	460	205	444	389	280
200	370	500	220	501	409	315
225	350	500	220	494	396	315

Elbow 45° PVC-U/PE100

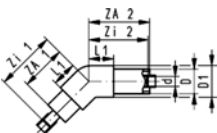

d [mm]	D [mm]	PN [bar]	PVC-U Tangit / PE Code	PVC-U Dytex / PE Code	kg
20	50	16 / 16	721 154 106	721 154 156	0.437
25	50	16 / 16	721 154 107	721 154 157	0.476
32	63	16 / 16	721 154 108	721 154 158	0.765
40	75	16 / 16	721 154 109	721 154 159	1.397
50	90	16 / 10	721 154 110	721 154 160	1.801
63	110	16 / 10	721 154 111	721 154 161	3.115
75	125	16 / 10	721 154 112	721 154 162	4.334
90	140	16 / 10	721 154 113	721 154 163	8.125
110	160	16 / 10	721 154 114	721 154 164	9.415
125	180	16 / 10	721 154 115	-	9.800

table continued next page

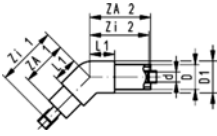

d [mm]	D [mm]	PN [bar]	PVC-U Tangit / PE Code	PVC-U Dytex / PE Code	kg
140	200	16 / 10	721 154 116	-	13.500
160	225	16 / 10	721 154 117	-	19.500
200	280	10 / 10	721 154 119	-	24.500
225	315	10 / 10	721 154 120	-	30.600

d [mm]	ZA 1 [mm]	ZA 2 [mm]	L1 [mm]	Zi 1 [mm]	Zi 2 [mm]	D1 [mm]
20	105	175	56	139	174	66
25	105	175	56	142	171	66
32	120	190	63	160	183	81
40	145	225	71	189	214	97
50	170	260	52	219	244	112
63	210	310	103	266	287	136
75	225	330	107	288	301	151
90	250	360	134	321	324	196
110	260	375	134	342	329	196
125	280	400	142	371	346	217
140	285	405	170	383	344	250
160	335	460	205	444	389	280
200	370	500	220	501	409	315
225	350	500	220	494	396	315



T90° equal PVC-U/PE100

- T 45° on request

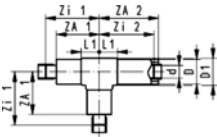

d [mm]	D [mm]	PN [bar]	PVC-U Tangit / PE Code	PVC-U Dytex / PE Code	kg
20	50	16 / 16	721 204 106	721 204 156	0.406
25	50	16 / 16	721 204 107	721 204 157	0.465
32	63	16 / 16	721 204 108	721 204 158	0.784
40	75	16 / 16	721 204 109	721 204 159	1.347
50	90	16 / 10	721 204 110	721 204 160	1.917
63	110	16 / 10	721 204 111	721 204 161	3.315
75	125	16 / 10	721 204 112	721 204 162	6.094
90	140	16 / 10	721 204 113	721 204 163	7.816
110	160	16 / 10	721 204 114	721 204 164	14.040
125	180	16 / 10	721 204 115		16.400
140	200	16 / 10	721 204 116		21.800
160	225	16 / 10	721 204 117		32.200
200	280	10 / 10	721 204 119		37.500
225	315	10 / 10	721 204 120		45.500

d [mm]	ZA 1 [mm]	ZA 2 [mm]	L1 [mm]	Zi 1 [mm]	Zi 2 [mm]	D1 [mm]
20	105	175	43	139	174	54
25	105	175	43	142	171	54
32	120	190	50	160	183	67
40	145	225	61	189	214	79
50	170	260	71	219	244	101
63	210	310	80	266	287	119
75	225	330	91	288	301	134
90	250	360	108	321	324	170
110	260	375	108	342	329	170
125	280	400	157	371	346	190

table continued next page

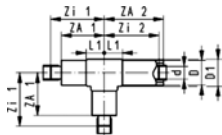

d [mm]	ZA 1 [mm]	ZA 2 [mm]	L1 [mm]	Zi 1 [mm]	Zi 2 [mm]	D1 [mm]
140	285	405	170	383	344	270
160	335	460	205	444	389	300
200	370	500	220	501	409	325
225	350	500	220	494	396	325



Termination fitting PVC-U/PE100

- Sealing in body EPDM

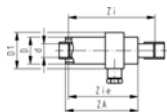

d [mm]	D [mm]	PN [bar]	PVC-U Tangit / PE Code	PVC-U Dytex / PE Code	kg
20	50	16 / 16	721 964 106	721 964 156	0.284
25	50	16 / 16	721 964 107	721 964 157	0.290
32	63	16 / 16	721 964 108	721 964 158	0.429
40	75	16 / 16	721 964 109	721 964 159	0.644
50	90	16 / 10	721 964 110	721 964 160	0.993
63	110	16 / 10	721 964 111	721 964 161	1.553
75	125	16 / 10	721 964 112	721 964 162	2.105
90	140	16 / 10	721 964 113	721 964 163	2.929
110	160	16 / 10	721 964 114	721 964 164	4.006
125	180	16 / 10	721 964 115		5.444
140	200	16 / 10	721 964 116		4.704
160	225	16 / 10	721 964 117		6.225
200	280	10 / 10	721 964 119		12.860
225	315	10 / 10	721 964 120		11.320

d [mm]	Za [mm]	Zi [mm]	Zie [mm]	D1 [mm]
20	175	208	174	70
25	175	208	171	70
32	185	218	178	80
40	205	238	194	90
50	250	283	234	110
63	270	303	247	130
75	290	324	261	140
90	310	345	274	160
110	330	366	284	170
125	345	282	291	190
140	360	397	299	210
160	390	428	319	230
200	375	415	283	280
225	430	470	326	315

21 23 91

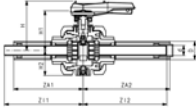

Ball valve type 546 PVC-U/PE100
Connections for solvent cementing with Tangit

Model:

- Manual operated
- Manual override with ratchet setting
- Pneumatic or electric actuator available separately
- Protective housing PVC-U PN6 / sealing according to inner pipe
- For easy installation and removal

d [mm]	D [mm]	PN [bar]	EPDM Code	FPM Code	kg
20	50	16 / 6	721 239 106	721 239 126	4.500
25	50	16 / 6	721 239 107	721 239 127	7.000
32	63	16 / 6	721 239 108	721 239 128	7.300
40	75	16 / 6	721 239 109	721 239 129	9.800
50	90	16 / 6	721 239 110	721 239 130	11.800
63	110	16 / 6	721 239 111	721 239 131	13.200

d [mm]	ZA 1 [mm]	ZA 2 [mm]	Zi 1 [mm]	Zi 2 [mm]	H [mm]	H1 [mm]	H2 [mm]
20	255	330	286	329	222	182	85
25	255	330	289	326	222	182	85
32	275	355	312	348	234	194	105
40	325	410	366	399	244	210	123
50	340	425	386	409	244	210	123
63	350	480	403	457	244	210	123

21 23 91

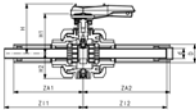

Ball valve type 546 PVC-U/PE100
Connections for solvent cementing with Dytex

Model:

- Manual operated
- Manual override with ratchet setting
- Pneumatic or electric actuator available separately
- Protective housing PVC-U PN6 / sealing according to inner pipe
- For easy installation and removal

d [mm]	D [mm]	PN [bar]	EPDM Code	FPM Code	kg
20	50	16 / 6	721 239 156	721 239 176	4.500
25	50	16 / 6	721 239 157	721 239 177	7.000
32	63	16 / 6	721 239 158	721 239 178	7.300
40	75	16 / 6	721 239 159	721 239 179	9.800
50	90	16 / 6	721 239 160	721 239 180	11.800
63	110	16 / 6	721 239 161	721 239 181	13.200

d [mm]	ZA 1 [mm]	ZA 2 [mm]	Zi 1 [mm]	Zi 2 [mm]	H [mm]	H1 [mm]	H2 [mm]
20	255	330	286	329	222	182	85
25	255	330	289	326	222	182	85
32	275	355	312	348	234	194	105
40	325	410	366	399	244	210	123
50	340	425	386	409	244	210	123
63	350	480	403	457	244	210	123

21 24 01

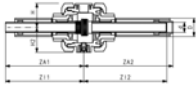

Mechanical joint PVC-U/PE100 Connections for solvent cementing with Tangit

Model:

- Protective housing PVC-U PN6 / sealing according to inner pipe
- With union PVC-U
- For easy installation and removal

d [mm]	D [mm]	PN [bar]	EPDM Code	FPM Code	kg
20	50	16 / 6	721 240 106	721 240 126	4.200
25	50	16 / 6	721 240 107	721 240 127	6.500
32	63	16 / 6	721 240 108	721 240 128	6.600
40	75	16 / 6	721 240 109	721 240 129	9.300
50	90	16 / 6	721 240 110	721 240 130	10.300
63	110	16 / 6	721 240 111	721 240 131	10.100

d [mm]	ZA 1 [mm]	ZA 2 [mm]	Zi 1 [mm]	Zi 2 [mm]	H [mm]	H2 [mm]
20	255	330	286	329	92	85
25	255	330	289	326	92	85
32	275	355	312	348	104	105
40	325	410	366	399	119	123
50	340	425	386	409	119	123
63	350	480	403	457	119	123

21 24 01

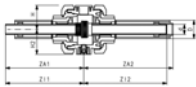

Mechanical joint PVC-U/PE100 Connections for solvent cementing with Dytex

Model:

- Protective housing PVC-U PN6 / sealing according to inner pipe
- With union PVC-U
- For easy installation and removal

d [mm]	D [mm]	PN [bar]	EPDM Code	FPM Code	kg
20	50	16 / 6	721 240 156	721 240 176	4.200
25	50	16 / 6	721 240 157	721 240 177	6.500
32	63	16 / 6	721 240 158	721 240 178	6.600
40	75	16 / 6	721 240 159	721 240 179	9.300
50	90	16 / 6	721 240 160	721 240 180	10.300
63	110	16 / 6	721 240 161	721 240 181	10.719

d [mm]	ZA 1 [mm]	ZA 2 [mm]	Zi 1 [mm]	Zi 2 [mm]	H [mm]	H2 [mm]
20	255	330	286	329	92	85
25	255	330	289	326	92	85
32	275	355	312	348	104	105
40	325	410	366	399	119	123
50	340	425	386	409	119	123
63	350	480	403	457	119	123

Inner pipe and connection elements PVC-U

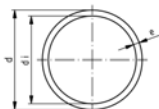

Pipe PVC-U, grey

Series S 6.3, SDR 13.6, nominal pressure PN 16

Model:

- Material: PVC-U, Polyvinylchloride unplasticised DIN 8061
- Colour: RAL 7011 - dark-grey
- Dimension: DIN EN ISO 15493, DIN 8062
- Pipe length: 5m, with plain ends

d [mm]	PN	Code	kg	e [mm]	di [mm]
20	16	161 017 106	0.137	1.5	17.0
25	16	161 017 107	0.212	1.9	21.2
32	16	161 017 108	0.342	2.4	27.2
40	16	161 017 109	0.525	3.0	34.0
50	16	161 017 110	0.809	3.7	42.6
63	16	161 017 111	1.290	4.7	53.6
75	16	161 017 112	1.820	5.6	58.2
90	16	161 017 113	2.610	6.7	76.6
110	16	161 017 114	3.856	8.1	93.8
125	16	161 017 115	4.956	9.2	106.6
140	16	161 017 116	6.215	10.3	119.4
160	16	161 017 117	8.109	11.8	136.4

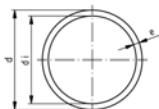

Pipe PVC-U, grey

Series S 10, SDR 21, nominal pressure PN 10

Model:

- Material: PVC-U, Polyvinylchloride unplasticised DIN 8061
- Colour: RAL 7011 - dark-grey
- Dimension: DIN EN ISO 15493, DIN 8062
- Pipe length: 5m, with plain ends
- Minimum order quantity: 1 length

d [mm]	PN	Code	e [mm]	di [mm]	Weight [kg/m]
200	10	161 017 094	9.6	180.8	8.510
225	10	161 017 095	10.8	203.4	10.800

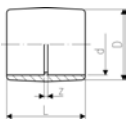

Sockets equal, PVC-U metric

d [mm]	PN	Code	kg	z [mm]	D [mm]	L [mm]
20	16	721 910 106	0.010	3	26	35
25	16	721 910 107	0.015	3	32	41
32	16	721 910 108	0.027	3	39	47
40	16	721 910 109	0.045	3	48	55
50	16	721 910 110	0.063	3	58	65
63	16	721 910 111	0.119	3	73	79
75	16	721 910 112	0.188	4	87	92
90	16	721 910 113	0.328	5	105	107
110	16	721 910 114	0.554	6	128	128
125	16	721 910 115	0.825	7	142	145
140	16	721 910 116	1.118	7	162	159

table continued next page

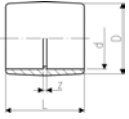

d [mm]	PN	Code	kg	z [mm]	D [mm]	L [mm]	
160	16	721 910 117	1.540	8	183	180	
200	10	721 910 119	2.559	9	221	221	
225	10	721 910 120	3.519	10	253	248	

Index

Code	Page
-	225
158 001 041	86
158 001 042	86
158 001 043	86
158 001 044	86
158 001 045	86
158 001 046	86
158 001 047	86
158 001 048	86
158 001 049	86
158 001 050	86
158 001 051	86
158 001 052	86
158 001 053	86
158 001 054	86
158 001 055	86
158 001 056	86
158 001 057	86
158 001 058	86
158 001 059	86
158 001 060	86
158 001 061	86
158 001 062	86
158 001 063	86
158 001 064	86
158 001 065	86
158 001 066	86
158 001 067	86
158 001 068	86
158 001 069	86
158 001 070	86
158 001 071	86
158 001 072	86
158 001 073	86
158 001 074	86
158 001 075	86
158 001 076	87
158 001 077	87
158 001 078	87
158 001 079	87
158 001 080	87
158 001 081	87
158 001 082	87
158 001 083	87
158 001 084	87
158 001 085	87
158 001 086	87
158 001 087	87
158 001 088	87
158 001 089	87
158 001 090	87
158 001 091	87

Code	Page
158 001 092	87
158 001 093	87
158 001 094	87
158 001 095	87
158 001 096	87
158 001 097	87
158 001 098	87
158 001 099	87
158 001 100	87
158 001 101	87
158 001 102	87
158 001 103	87
158 001 104	87
158 001 105	87
158 001 106	87
158 001 107	87
158 001 108	87
158 001 109	87
158 001 110	87
158 001 111	87
158 001 112	87
158 001 113	87
158 001 114	87
158 001 115	87
158 001 116	87
158 001 117	87
158 001 118	87
158 001 119	87
158 001 120	87
158 001 121	87
158 001 122	87
158 001 123	87
158 001 124	87
160 100 250	56
160 100 300	56
160 100 350	56
161 017 037	34
161 017 038	34
161 017 039	34
161 017 040	34
161 017 041	34
161 017 042	34
161 017 043	34
161 017 044	34
161 017 045	34
161 017 046	34
161 017 047	34
161 017 048	34
161 017 060	33
161 017 061	33
161 017 062	33
161 017 063	33

Code	Page
161 017 064	33
161 017 065	33
161 017 066	33
161 017 067	33
161 017 068	33
161 017 069	33
161 017 070	33
161 017 071	33
161 017 072	33
161 017 073	33
161 017 074	33
161 017 082	33
161 017 083	33
161 017 084	33
161 017 085	33
161 017 086	33
161 017 087	33
161 017 088	33
161 017 089	33
161 017 090	33
161 017 091	33
161 017 093	33
161 017 094	33
161 017 095	33
161 017 096	33
161 017 097	33
161 017 098	33
161 017 104	32
161 017 105	32
161 017 106	32
161 017 107	32
161 017 108	32
161 017 109	32
161 017 110	32
161 017 111	32
161 017 112	4
161 017 113	32
161 017 114	32
161 017 115	32
161 017 116	4
161 017 117	32
161 017 126	32
161 017 127	32
161 017 128	32
161 017 129	32
161 017 130	32
161 017 131	32
161 017 132	32
161 017 133	32
161 017 134	32
161 017 135	32
161 017 136	32

Index

Code	Page
161 017 137	32
161 017 138	32
161 017 139	32
161 018 036	4
161 018 038	4
161 018 039	4
161 018 042	4
161 018 045	4
161 018 059	4
161 018 060	4
161 018 061	4
161 018 063	4
161 018 064	4
161 018 080	4
161 018 082	4
161 018 083	4
161 018 084	4
161 018 085	4
161 018 086	4
161 018 087	4
161 018 088	4
161 018 089	4
161 018 255	5
161 018 256	5
161 018 257	5
161 018 258	5
161 018 259	5
161 018 260	5
161 018 261	5
161 050 026	183
161 050 027	183
161 050 028	183
161 050 029	183
161 050 030	183
161 050 031	183
161 050 032	183
161 050 033	183
161 050 034	183
161 050 226	26
161 050 227	26
161 050 228	26
161 050 229	26
161 050 230	26
161 050 231	26
161 050 245	82
161 050 246	82
161 050 247	82
161 050 248	82
161 050 249	82
161 050 250	82
161 050 251	82
161 050 345	82

Code	Page
161 050 346	82
161 050 347	82
161 050 348	82
161 050 349	82
161 050 350	82
161 050 351	82
161 090 016	184
161 090 017	184
161 090 018	184
161 090 019	184
161 090 024	184
161 108 706	26
161 108 707	26
161 110 035	84
161 110 036	84
161 110 055	84
161 110 056	84
161 110 057	84
161 110 065	84
161 110 066	84
161 110 067	84
161 110 095	84
161 110 096	84
161 110 097	84
161 110 116	84
161 110 117	84
161 110 230	85
161 110 250	85
161 110 260	85
161 110 290	85
161 110 310	85
161 111 035	84
161 111 036	84
161 111 046	84
161 111 055	84
161 111 056	84
161 111 065	84
161 111 066	84
161 111 067	84
161 111 095	84
161 111 096	84
161 111 097	84
161 111 116	84
161 111 117	84
161 117 055	27
161 117 056	27
161 117 057	27
161 117 065	27
161 117 066	27
161 117 067	27
161 117 095	27
161 117 096	27

Code	Page
161 117 097	27
161 123 250	159
161 123 300	159
161 123 350	159
161 123 400	159
161 123 450	159
161 137 055	27
161 137 056	27
161 137 057	27
161 137 065	27
161 137 066	27
161 137 067	27
161 137 095	27
161 137 096	27
161 137 097	27
161 280 026	85
161 280 027	85
161 280 113	85
161 280 114	85
161 280 115	85
161 280 116	85
161 300 250	158
161 300 299	158
161 300 300	158
161 300 349	158
161 300 350	158
161 300 399	158
161 300 400	158
161 300 449	158
161 300 450	158
161 300 499	158
161 300 500	158
161 300 549	158
161 300 550	158
161 300 599	158
161 300 600	158
161 300 649	158
161 300 650	158
161 300 699	158
161 303 005	159
161 303 006	159
161 303 007	159
161 303 008	159
161 303 009	159
161 303 010	159
161 303 011	159
161 303 012	159
161 303 013	159
161 303 030	159
161 303 031	159
161 303 032	159
161 303 033	159

Index

Code	Page
161 303 034	159
161 303 035	159
161 303 036	159
161 303 037	159
161 303 038	159
161 305 300	180
161 305 336	182
161 305 337	182
161 305 338	181
161 305 339	181
161 305 349	180
161 305 350	180
161 305 386	182
161 305 387	182
161 305 388	181
161 305 389	181
161 305 399	180
161 305 400	180
161 305 436	182
161 305 437	182
161 305 438	181
161 305 439	181
161 305 449	180
161 305 450	180
161 305 486	182
161 305 487	182
161 305 488	181
161 305 489	181
161 305 499	180
161 305 500	180
161 305 536	182
161 305 537	182
161 305 538	181
161 305 539	181
161 305 549	180
161 305 550	180
161 305 586	182
161 305 587	182
161 305 588	181
161 305 589	181
161 305 599	180
161 305 600	180
161 305 636	182
161 305 637	182
161 305 638	181
161 305 639	181
161 305 649	180
161 305 650	180
161 305 686	182
161 305 687	182
161 305 688	181
161 305 689	181

Code	Page
161 305 699	180
161 317 009	141
161 317 010	141
161 317 012	141
161 317 024	141
161 317 025	141
161 317 027	141
161 317 039	141
161 317 040	141
161 317 042	141
161 317 054	141
161 317 055	141
161 317 057	141
161 317 069	141
161 317 070	141
161 317 072	141
161 317 508	141
161 317 523	141
161 317 538	141
161 317 553	141
161 317 568	141
161 322 150	135
161 322 199	135
161 322 200	135
161 322 249	135
161 323 401	133
161 323 402	133
161 323 411	133
161 323 412	133
161 323 421	132
161 323 422	132
161 323 431	132
161 323 432	132
161 323 441	132
161 323 442	132
161 323 451	132
161 323 452	132
161 323 501	132
161 323 502	132
161 323 511	132
161 323 512	132
161 324 150	135
161 324 199	135
161 324 200	135
161 324 249	135
161 353 002	116
161 353 003	116
161 353 004	116
161 353 005	116
161 353 006	116
161 353 007	116
161 353 022	115

Code	Page
161 353 023	115
161 353 024	115
161 353 025	115
161 353 026	115
161 353 027	115
161 353 302	115
161 353 303	115
161 353 304	115
161 353 305	115
161 353 306	115
161 353 307	115
161 354 002	117
161 354 003	117
161 354 004	117
161 354 005	117
161 354 006	117
161 354 007	117
161 354 022	116
161 354 023	116
161 354 024	116
161 354 025	116
161 354 026	116
161 354 027	116
161 354 302	116
161 354 303	116
161 354 304	116
161 354 305	116
161 354 306	116
161 354 307	116
161 355 002	117
161 355 003	117
161 355 004	117
161 355 005	117
161 355 006	117
161 355 007	117
161 355 022	118
161 355 023	118
161 355 024	118
161 355 025	118
161 355 026	118
161 355 027	118
161 355 202	117
161 355 203	117
161 355 204	117
161 355 205	117
161 355 206	117
161 355 207	117
161 355 522	118
161 355 523	118
161 355 524	118
161 355 525	118
161 355 526	118

Index

Code	Page
161 355 527	118
161 360 013	162
161 360 038	162
161 360 401	161
161 360 402	161
161 360 403	161
161 360 404	161
161 360 405	161
161 360 406	161
161 360 407	161
161 360 411	161
161 360 412	161
161 360 413	161
161 360 414	161
161 360 415	161
161 360 416	161
161 360 417	161
161 360 421	163
161 360 422	163
161 360 423	163
161 360 424	163
161 360 425	163
161 360 426	163
161 360 427	163
161 360 431	163
161 360 432	163
161 360 433	163
161 360 434	163
161 360 435	163
161 360 436	163
161 360 437	163
161 360 441	162
161 360 442	162
161 360 443	162
161 360 444	162
161 360 445	162
161 360 446	162
161 360 447	162
161 360 451	162
161 360 452	162
161 360 453	162
161 360 454	162
161 360 455	162
161 360 456	162
161 360 457	162
161 360 502	163
161 360 503	163
161 360 504	163
161 360 505	163
161 360 506	163
161 360 507	163
161 360 512	163

Code	Page
161 360 513	163
161 360 514	163
161 360 515	163
161 360 516	163
161 360 517	163
161 360 521	161
161 360 522	161
161 360 523	161
161 360 524	161
161 360 525	161
161 360 526	161
161 360 527	161
161 360 531	161
161 360 532	161
161 360 533	161
161 360 534	161
161 360 535	161
161 360 536	161
161 360 537	161
161 369 002	176
161 369 003	176
161 369 004	176
161 369 005	176
161 369 006	176
161 369 007	176
161 369 009	176
161 369 010	176
161 369 011	176
161 369 012	176
161 369 013	176
161 369 022	176
161 369 023	176
161 369 024	176
161 369 025	176
161 369 026	176
161 369 027	176
161 369 029	176
161 369 030	176
161 369 031	176
161 369 032	176
161 369 033	176
161 369 042	177
161 369 043	177
161 369 044	177
161 369 045	177
161 369 046	177
161 369 047	177
161 369 049	177
161 369 050	177
161 369 051	177
161 369 052	177
161 369 053	177

Code	Page
161 369 062	177
161 369 063	177
161 369 064	177
161 369 065	177
161 369 066	177
161 369 067	177
161 369 069	177
161 369 070	177
161 369 071	177
161 369 072	177
161 369 073	177
161 369 082	178
161 369 083	178
161 369 084	178
161 369 085	178
161 369 086	178
161 369 087	178
161 369 089	179
161 369 090	179
161 369 091	179
161 369 092	179
161 369 093	179
161 369 102	178
161 369 103	178
161 369 104	178
161 369 105	178
161 369 106	178
161 369 107	178
161 369 109	179
161 369 110	179
161 369 111	179
161 369 112	179
161 369 113	179
161 375 501	113
161 375 502	113
161 375 503	113
161 375 504	113
161 375 505	113
161 375 506	113
161 375 507	113
161 375 508	112
161 375 509	113
161 375 510	113
161 375 511	113
161 375 512	113
161 375 513	113
161 375 514	113
161 375 515	113
161 375 516	113
161 375 517	113
161 375 518	112
161 375 519	113

Index

Code	Page
161 375 520	113
161 375 521	114
161 375 522	114
161 375 523	114
161 375 524	114
161 375 525	114
161 375 526	114
161 375 527	114
161 375 528	114
161 375 529	114
161 375 530	114
161 375 531	114
161 375 532	114
161 375 533	114
161 375 534	114
161 375 535	114
161 375 536	114
161 375 537	114
161 375 538	114
161 375 539	114
161 375 540	114
161 375 601	112
161 375 602	112
161 375 603	112
161 375 604	112
161 375 605	112
161 375 606	112
161 375 607	112
161 375 609	112
161 375 610	112
161 375 611	112
161 375 612	112
161 375 613	112
161 375 614	112
161 375 615	112
161 375 616	112
161 375 617	112
161 375 619	112
161 375 620	112
161 483 180	217
161 486 006	145
161 486 007	145
161 486 008	145
161 486 009	145
161 486 010	145
161 486 100	182
161 486 101	182
161 486 102	182
161 486 103	182
161 486 104	182
161 486 105	182
161 486 106	182

Code	Page
161 486 107	182
161 486 301	145
161 486 302	145
161 486 303	145
161 486 304	145
161 486 305	145
161 486 435	106
161 486 436	106
161 486 437	106
161 486 438	106
161 486 443	106
161 486 444	106
161 486 445	106
161 486 446	106
161 486 689	105
161 486 690	105
161 486 691	105
161 486 855	145
161 486 856	145
161 486 857	145
161 486 858	145
161 486 859	145
161 490 920	107
161 490 921	107
161 514 001	137
161 514 002	137
161 514 003	137
161 514 004	137
161 514 005	137
161 514 006	137
161 514 007	137
161 514 011	137
161 514 012	137
161 514 013	137
161 514 014	137
161 514 015	137
161 514 016	137
161 514 017	137
161 514 031	137
161 514 032	137
161 514 033	137
161 514 034	137
161 514 035	137
161 514 036	137
161 514 037	137
161 514 061	137
161 514 062	137
161 514 063	137
161 514 064	137
161 514 065	137
161 514 066	137
161 514 067	137

Code	Page
161 514 402	138
161 514 403	138
161 514 404	138
161 514 405	138
161 514 406	138
161 514 407	138
161 514 412	138
161 514 413	138
161 514 414	138
161 514 415	138
161 514 416	138
161 514 417	138
161 514 432	138
161 514 433	138
161 514 434	138
161 514 435	138
161 514 436	138
161 514 437	138
161 514 462	138
161 514 463	138
161 514 464	138
161 514 465	138
161 514 466	138
161 514 467	138
161 514 502	136
161 514 503	136
161 514 504	136
161 514 505	136
161 514 506	136
161 514 507	136
161 514 512	136
161 514 513	136
161 514 514	136
161 514 515	136
161 514 516	136
161 514 517	136
161 514 532	136
161 514 533	136
161 514 534	136
161 514 535	136
161 514 536	136
161 514 537	136
161 514 562	136
161 514 563	136
161 514 564	136
161 514 565	136
161 514 566	136
161 514 567	136
161 515 002	139
161 515 003	139
161 515 004	139
161 515 005	139

Index

Code	Page
161 515 006	139
161 515 007	139
161 515 012	139
161 515 013	139
161 515 014	139
161 515 015	139
161 515 016	139
161 515 017	139
161 515 032	139
161 515 033	139
161 515 034	139
161 515 035	139
161 515 036	139
161 515 037	139
161 515 062	139
161 515 063	139
161 515 064	139
161 515 065	139
161 515 066	139
161 515 067	139
161 517 002	140
161 517 003	140
161 517 004	140
161 517 005	140
161 517 006	140
161 517 007	140
161 517 012	140
161 517 013	140
161 517 014	140
161 517 015	140
161 517 016	140
161 517 017	140
161 517 032	140
161 517 033	140
161 517 034	140
161 517 035	140
161 517 036	140
161 517 037	140
161 517 062	140
161 517 063	140
161 517 064	140
161 517 065	140
161 517 066	140
161 517 067	140
161 543 001	123
161 543 002	123
161 543 003	123
161 543 004	123
161 543 005	123
161 543 006	123
161 543 007	123
161 543 011	123

Code	Page
161 543 012	123
161 543 013	123
161 543 014	123
161 543 015	123
161 543 016	123
161 543 017	123
161 543 041	124
161 543 042	124
161 543 043	124
161 543 044	124
161 543 045	124
161 543 046	124
161 543 047	124
161 543 051	124
161 543 052	124
161 543 053	124
161 543 054	124
161 543 055	124
161 543 056	124
161 543 057	124
161 543 061	125
161 543 062	125
161 543 063	125
161 543 064	125
161 543 065	125
161 543 066	125
161 543 067	125
161 543 071	125
161 543 072	125
161 543 073	125
161 543 074	125
161 543 075	125
161 543 076	125
161 543 077	125
161 543 201	127
161 543 202	127
161 543 203	127
161 543 204	127
161 543 205	127
161 543 206	127
161 543 207	127
161 543 211	127
161 543 212	127
161 543 213	127
161 543 214	127
161 543 215	127
161 543 216	127
161 543 217	127
161 543 221	129
161 543 222	129
161 543 223	129
161 543 224	129

Code	Page
161 543 225	129
161 543 226	129
161 543 227	129
161 543 231	129
161 543 232	129
161 543 233	129
161 543 234	129
161 543 235	129
161 543 236	129
161 543 237	129
161 543 241	128
161 543 242	128
161 543 243	128
161 543 244	128
161 543 245	128
161 543 246	128
161 543 247	128
161 543 251	128
161 543 252	128
161 543 253	128
161 543 254	128
161 543 255	128
161 543 256	128
161 543 257	128
161 543 261	126
161 543 262	126
161 543 263	126
161 543 264	126
161 543 265	126
161 543 266	126
161 543 267	126
161 543 271	126
161 543 272	126
161 543 273	126
161 543 274	126
161 543 275	126
161 543 276	126
161 543 277	126
161 543 401	119
161 543 402	119
161 543 403	119
161 543 404	119
161 543 405	119
161 543 406	119
161 543 407	119
161 543 411	119
161 543 412	119
161 543 413	119
161 543 414	119
161 543 415	119
161 543 416	119
161 543 417	119

Index

Code	Page
161 543 421	120
161 543 422	120
161 543 423	120
161 543 424	120
161 543 425	120
161 543 426	120
161 543 427	120
161 543 431	120
161 543 432	120
161 543 433	120
161 543 434	120
161 543 435	120
161 543 436	120
161 543 437	120
161 543 441	121
161 543 442	121
161 543 443	121
161 543 444	121
161 543 445	121
161 543 446	121
161 543 447	121
161 543 451	121
161 543 452	121
161 543 453	121
161 543 454	121
161 543 455	121
161 543 456	121
161 543 457	121
161 543 482	130
161 543 483	130
161 543 484	130
161 543 485	130
161 543 486	130
161 543 487	130
161 543 492	130
161 543 493	130
161 543 494	130
161 543 495	130
161 543 496	130
161 543 497	130
161 543 601	122
161 543 602	122
161 543 603	122
161 543 604	122
161 543 605	122
161 543 606	122
161 543 607	122
161 543 611	122
161 543 612	122
161 543 613	122
161 543 614	122
161 543 615	122

Code	Page
161 543 616	122
161 543 617	122
161 546 001	98
161 546 002	98
161 546 003	98
161 546 004	98
161 546 005	98
161 546 006	98
161 546 007	98
161 546 008	90
161 546 009	98
161 546 010	98
161 546 011	98
161 546 012	98
161 546 013	98
161 546 014	98
161 546 015	98
161 546 016	98
161 546 017	98
161 546 018	90
161 546 019	98
161 546 020	98
161 546 021	100
161 546 022	100
161 546 023	100
161 546 024	100
161 546 025	100
161 546 026	100
161 546 027	100
161 546 028	100
161 546 029	100
161 546 030	100
161 546 031	100
161 546 032	100
161 546 033	100
161 546 034	100
161 546 035	100
161 546 036	100
161 546 037	100
161 546 038	100
161 546 039	100
161 546 040	100
161 546 041	99
161 546 042	99
161 546 043	99
161 546 044	99
161 546 045	99
161 546 046	99
161 546 047	99
161 546 048	99
161 546 049	99
161 546 050	99

Code	Page
161 546 051	99
161 546 052	99
161 546 053	99
161 546 054	99
161 546 055	99
161 546 056	99
161 546 057	99
161 546 058	99
161 546 059	99
161 546 060	99
161 546 061	94
161 546 062	94
161 546 063	94
161 546 064	94
161 546 065	94
161 546 066	94
161 546 067	94
161 546 068	91
161 546 069	94
161 546 070	94
161 546 071	94
161 546 072	94
161 546 073	94
161 546 074	94
161 546 075	94
161 546 076	94
161 546 077	94
161 546 078	91
161 546 079	94
161 546 080	94
161 546 081	93
161 546 082	93
161 546 083	93
161 546 084	93
161 546 085	93
161 546 086	93
161 546 087	93
161 546 088	92
161 546 089	93
161 546 090	93
161 546 091	93
161 546 092	93
161 546 093	93
161 546 094	93
161 546 095	93
161 546 096	93
161 546 097	93
161 546 098	92
161 546 099	93
161 546 100	93
161 546 108	97
161 546 109	97

Index

Code	Page
161 546 110	97
161 546 118	97
161 546 119	97
161 546 120	97
161 546 201	90
161 546 202	90
161 546 203	90
161 546 204	90
161 546 205	90
161 546 206	90
161 546 207	90
161 546 209	90
161 546 210	90
161 546 211	90
161 546 212	90
161 546 213	90
161 546 214	90
161 546 215	90
161 546 216	90
161 546 217	90
161 546 219	90
161 546 220	90
161 546 221	92
161 546 222	92
161 546 223	92
161 546 224	92
161 546 225	92
161 546 226	92
161 546 227	92
161 546 229	92
161 546 230	92
161 546 231	92
161 546 232	92
161 546 233	92
161 546 234	92
161 546 235	92
161 546 236	92
161 546 237	92
161 546 239	92
161 546 240	92
161 546 241	91
161 546 242	91
161 546 243	91
161 546 244	91
161 546 245	91
161 546 246	91
161 546 247	91
161 546 249	91
161 546 250	91
161 546 251	91
161 546 252	91
161 546 253	91

Code	Page
161 546 254	91
161 546 255	91
161 546 256	91
161 546 257	91
161 546 259	91
161 546 260	91
161 546 301	104
161 546 302	104
161 546 303	104
161 546 304	104
161 546 305	104
161 546 306	104
161 546 307	104
161 546 308	104
161 546 309	104
161 546 310	104
161 546 311	104
161 546 312	104
161 546 313	104
161 546 314	104
161 546 315	104
161 546 316	104
161 546 317	104
161 546 318	104
161 546 319	104
161 546 320	104
161 546 341	102
161 546 342	102
161 546 343	102
161 546 344	102
161 546 345	102
161 546 346	102
161 546 347	102
161 546 348	102
161 546 349	102
161 546 350	102
161 546 351	102
161 546 352	102
161 546 353	102
161 546 354	102
161 546 355	102
161 546 356	102
161 546 357	102
161 546 358	102
161 546 359	102
161 546 360	102
161 546 361	103
161 546 362	103
161 546 363	103
161 546 364	103
161 546 365	103
161 546 366	103

Code	Page
161 546 367	103
161 546 368	103
161 546 369	103
161 546 370	103
161 546 371	103
161 546 372	103
161 546 373	103
161 546 374	103
161 546 375	103
161 546 376	103
161 546 377	103
161 546 378	103
161 546 379	103
161 546 380	103
161 546 761	95
161 546 762	95
161 546 763	95
161 546 764	95
161 546 765	95
161 546 766	95
161 546 767	95
161 546 771	95
161 546 772	95
161 546 773	95
161 546 774	95
161 546 775	95
161 546 776	95
161 546 777	95
161 546 822	96
161 546 823	96
161 546 824	96
161 546 825	96
161 546 826	96
161 546 827	96
161 546 828	96
161 546 829	96
161 546 830	96
161 546 832	96
161 546 833	96
161 546 834	96
161 546 835	96
161 546 836	96
161 546 837	96
161 546 838	96
161 546 839	96
161 546 840	96
161 561 001	166
161 561 002	166
161 561 003	166
161 561 004	166
161 561 005	166
161 561 006	166

Index

Code	Page
161 561 007	166
161 561 008	166
161 561 009	166
161 561 010	166
161 561 011	166
161 561 012	166
161 561 013	166
161 561 014	166
161 561 015	166
161 561 016	166
161 561 017	166
161 561 018	166
161 561 019	166
161 561 020	166
161 561 021	168
161 561 022	168
161 561 023	168
161 561 024	168
161 561 025	168
161 561 026	168
161 561 027	168
161 561 028	168
161 561 029	168
161 561 030	168
161 561 031	168
161 561 032	168
161 561 033	168
161 561 034	168
161 561 035	168
161 561 036	168
161 561 037	168
161 561 038	168
161 561 039	168
161 561 040	168
161 561 041	167
161 561 042	167
161 561 043	167
161 561 044	167
161 561 045	167
161 561 046	167
161 561 047	167
161 561 048	167
161 561 049	167
161 561 050	167
161 561 051	167
161 561 052	167
161 561 053	167
161 561 054	167
161 561 055	167
161 561 056	167
161 561 057	167
161 561 058	167

Code	Page
161 561 059	167
161 561 060	167
161 561 061	164
161 561 062	164
161 561 063	164
161 561 064	164
161 561 065	164
161 561 066	164
161 561 067	164
161 561 069	164
161 561 070	164
161 561 071	164
161 561 072	164
161 561 073	164
161 561 074	164
161 561 075	164
161 561 076	164
161 561 077	164
161 561 079	164
161 561 080	164
161 561 082	169
161 561 083	169
161 561 084	169
161 561 085	169
161 561 086	169
161 561 087	169
161 561 092	169
161 561 093	169
161 561 094	169
161 561 095	169
161 561 096	169
161 561 097	169
161 562 001	169
161 562 002	169
161 562 003	169
161 562 004	169
161 562 005	169
161 562 006	169
161 562 007	170
161 562 008	170
161 562 009	170
161 562 010	170
161 562 011	169
161 562 012	169
161 562 013	169
161 562 014	169
161 562 015	169
161 562 016	169
161 562 017	170
161 562 018	170
161 562 019	170
161 562 020	170

Code	Page
161 562 021	171
161 562 022	171
161 562 023	171
161 562 024	171
161 562 025	171
161 562 026	171
161 562 027	171
161 562 028	171
161 562 029	171
161 562 030	171
161 562 031	171
161 562 032	171
161 562 033	171
161 562 034	171
161 562 035	171
161 562 036	171
161 562 037	171
161 562 038	171
161 562 039	171
161 562 040	171
161 562 041	170
161 562 042	170
161 562 043	170
161 562 044	170
161 562 045	170
161 562 046	170
161 562 047	170
161 562 048	170
161 562 049	170
161 562 050	170
161 562 051	170
161 562 052	170
161 562 053	170
161 562 054	170
161 562 055	170
161 562 056	170
161 562 057	170
161 562 058	170
161 562 059	170
161 562 060	170
161 562 061	165
161 562 062	165
161 562 063	165
161 562 064	165
161 562 065	165
161 562 066	165
161 562 067	165
161 562 069	165
161 562 070	165
161 562 071	165
161 562 072	165
161 562 073	165

Index

Code	Page
161 562 074	165
161 562 075	165
161 562 076	165
161 562 077	165
161 562 079	165
161 562 080	165
161 562 082	172
161 562 083	172
161 562 084	172
161 562 085	172
161 562 086	172
161 562 087	172
161 562 092	172
161 562 093	172
161 562 094	172
161 562 095	172
161 562 096	172
161 562 097	172
161 567 002	143
161 567 003	143
161 567 004	143
161 567 005	143
161 567 006	143
161 567 007	143
161 567 008	143
161 567 009	143
161 567 010	143
161 567 022	143
161 567 023	143
161 567 024	143
161 567 025	143
161 567 026	143
161 567 027	143
161 567 028	143
161 567 029	143
161 567 030	143
161 567 042	144
161 567 043	144
161 567 044	144
161 567 045	144
161 567 046	144
161 567 047	144
161 567 048	144
161 567 049	144
161 567 050	144
161 567 051	144
161 567 052	144
161 567 062	144
161 567 063	144
161 567 064	144
161 567 065	144
161 567 066	144

Code	Page
161 567 067	144
161 567 068	144
161 567 069	144
161 567 070	144
161 567 071	144
161 567 072	144
161 567 802	142
161 567 803	142
161 567 804	142
161 567 805	142
161 567 806	142
161 567 807	142
161 567 808	142
161 567 809	142
161 567 810	142
161 567 811	142
161 567 812	142
161 567 822	142
161 567 823	142
161 567 824	142
161 567 825	142
161 567 826	142
161 567 827	142
161 567 828	142
161 567 829	142
161 567 830	142
161 567 831	142
161 567 832	142
161 568 002	146
161 568 003	146
161 568 004	146
161 568 005	146
161 568 006	146
161 568 007	146
161 568 008	146
161 568 022	146
161 568 023	146
161 568 024	146
161 568 025	146
161 568 026	146
161 568 027	146
161 568 028	146
161 568 042	147
161 568 043	147
161 568 044	147
161 568 045	147
161 568 046	147
161 568 047	147
161 568 048	147
161 568 062	147
161 568 063	147
161 568 064	147

Code	Page
161 568 065	147
161 568 066	147
161 568 067	147
161 568 068	147
161 568 102	148
161 568 103	148
161 568 104	148
161 568 105	148
161 568 106	148
161 568 107	148
161 568 108	148
161 568 122	148
161 568 123	148
161 568 124	148
161 568 125	148
161 568 126	148
161 568 127	148
161 568 128	148
161 568 142	149
161 568 143	149
161 568 144	149
161 568 145	149
161 568 146	149
161 568 147	149
161 568 148	149
161 568 162	149
161 568 163	149
161 568 164	149
161 568 165	149
161 568 166	149
161 568 167	149
161 568 168	149
161 591 001	173
161 591 002	173
161 591 003	173
161 591 004	173
161 591 005	173
161 591 006	173
161 591 007	173
161 591 008	173
161 591 009	173
161 591 010	173
161 591 011	173
161 591 012	173
161 591 013	173
161 591 014	173
161 591 015	173
161 591 016	173
161 591 017	173
161 591 018	173
161 591 019	173
161 591 020	173

Index

Code	Page
161 591 041	173
161 591 042	173
161 591 043	173
161 591 044	173
161 591 045	173
161 591 046	173
161 591 047	173
161 591 048	173
161 591 049	173
161 591 050	173
161 591 051	173
161 591 052	173
161 591 053	173
161 591 054	173
161 591 055	173
161 591 056	173
161 591 057	173
161 591 058	173
161 591 059	173
161 591 060	173
161 591 061	174
161 591 062	174
161 591 063	174
161 591 064	174
161 591 065	174
161 591 066	174
161 591 067	174
161 591 069	174
161 591 070	174
161 591 071	174
161 591 072	174
161 591 073	174
161 591 074	174
161 591 075	174
161 591 076	174
161 591 077	174
161 591 079	174
161 591 080	174
161 595 001	174
161 595 002	174
161 595 003	174
161 595 004	174
161 595 005	174
161 595 006	174
161 595 007	174
161 595 008	174
161 595 009	174
161 595 010	174
161 595 011	174
161 595 012	174
161 595 013	174
161 595 014	174

Code	Page
161 595 015	174
161 595 016	174
161 595 017	174
161 595 018	174
161 595 019	174
161 595 020	174
161 595 041	175
161 595 042	175
161 595 043	175
161 595 044	175
161 595 045	175
161 595 046	175
161 595 047	175
161 595 048	175
161 595 049	175
161 595 050	175
161 595 051	175
161 595 052	175
161 595 053	175
161 595 054	175
161 595 055	175
161 595 056	175
161 595 057	175
161 595 058	175
161 595 059	175
161 595 060	175
167 060 019	207
167 060 020	207
167 060 021	207
167 060 022	207
167 060 023	207
167 060 024	207
167 060 025	207
167 060 038	207
167 060 039	207
167 060 040	207
167 060 041	207
167 060 042	207
167 060 043	207
167 060 064	208
167 060 067	208
167 060 070	208
167 061 003	205
167 061 004	205
167 061 012	204
167 061 013	204
167 061 014	205
167 061 015	205
167 061 016	204
167 061 017	205
167 061 035	205
167 061 036	205

Code	Page
167 061 037	205
167 061 038	205
167 061 039	205
167 061 040	205
167 061 041	205
167 061 054	204
167 061 055	204
167 061 056	204
167 061 057	204
167 061 058	204
167 061 059	204
167 061 060	204
167 061 061	204
167 061 114	204
167 061 153	205
167 061 155	205
167 061 156	205
167 061 157	205
167 061 158	205
167 061 159	205
167 061 160	206
167 061 161	206
167 061 162	206
167 061 163	206
167 061 164	206
167 061 165	206
167 061 166	206
167 061 167	206
167 482 626	108
167 482 627	108
167 482 628	108
167 482 629	108
167 482 630	108
167 482 631	108
167 482 635	109
167 482 636	109
167 482 637	109
167 482 638	109
167 482 639	109
167 482 640	109
167 482 653	111
167 482 654	111
167 482 655	111
167 482 656	111
167 482 657	111
167 482 658	111
167 482 662	110
167 482 663	110
167 482 664	110
167 482 665	110
167 482 666	110
167 482 667	110

Index

Code	Page
167 482 671	110
167 482 672	110
167 482 673	110
167 482 674	110
167 482 675	110
167 482 676	110
167 482 680	108
167 482 681	108
167 482 682	108
167 482 683	108
167 482 684	108
167 482 685	108
167 484 076	105
167 484 077	105
167 484 078	105
167 484 079	105
167 484 080	105
167 484 081	105
167 484 082	105
167 484 083	105
167 484 084	105
167 484 088	105
167 484 089	105
167 484 090	105
167 484 091	105
167 484 092	105
167 484 093	105
167 484 094	105
167 484 095	105
167 484 096	105
167 484 100	105
167 484 101	105
167 484 102	105
167 484 103	105
167 484 104	105
167 484 105	105
167 484 110	107
167 484 111	107
167 484 642	131
167 484 643	131
167 484 644	131
167 484 645	131
167 484 646	131
167 484 647	131
167 484 688	131
167 484 689	131
167 484 690	131
167 484 691	131
167 484 692	131
167 484 693	131
167 484 742	131
167 484 743	131

Code	Page
167 484 744	131
167 484 745	131
167 484 746	131
167 484 747	131
167 484 788	131
167 484 789	131
167 484 790	131
167 484 791	131
167 484 792	131
167 484 793	131
167 484 945	131
167 484 946	131
167 484 947	131
167 484 948	131
173 061 003	206
173 061 004	206
173 061 005	206
173 061 006	206
173 061 007	206
173 061 008	206
173 061 009	206
173 061 010	206
173 061 011	206
173 061 012	206
173 061 013	206
173 061 014	206
173 061 015	206
173 061 016	206
173 061 017	206
173 061 153	206
173 061 155	206
173 061 156	206
173 061 157	206
173 061 158	206
173 061 159	206
173 061 160	206
173 061 161	206
173 061 162	206
173 061 163	206
173 061 164	206
173 061 165	207
173 061 166	207
173 061 167	207
192 017 036	36
192 017 037	36
192 017 038	36
192 017 039	36
192 017 040	36
192 017 041	36
192 017 042	36
192 017 044	36
192 017 045	36

Code	Page
192 017 046	36
192 017 047	36
192 017 060	36
192 017 080	36
192 017 082	35
192 017 083	35
192 017 084	35
192 017 085	35
192 017 086	35
192 017 087	36
192 017 088	36
192 017 089	36
192 017 104	35
192 017 105	35
192 017 106	35
192 017 107	35
192 017 108	35
192 017 109	35
192 017 110	35
192 017 111	35
192 305 300	180
192 305 349	180
192 305 350	180
192 305 399	180
192 305 400	180
192 305 449	180
192 305 450	180
192 305 499	180
192 305 500	180
192 305 549	180
192 305 550	180
192 305 599	180
192 305 600	180
192 305 649	180
192 305 650	180
192 305 699	180
192 306 300	181
192 306 349	181
192 306 350	181
192 306 399	181
192 306 400	181
192 306 449	181
192 306 450	181
192 306 499	181
192 306 500	181
192 306 549	181
192 306 550	181
192 306 599	181
192 306 650	181
192 306 699	181
193 017 113	233
193 017 114	233

Index

Code	Page
193 017 115	233
193 017 116	233
193 017 117	233
193 017 118	233
193 017 119	233
193 017 120	233
193 017 121	233
193 017 122	233
193 017 123	233
193 017 160	233
193 017 161	233
193 017 162	233
193 131 037	238
193 131 047	238
193 131 057	238
193 131 067	238
193 131 077	238
193 131 087	238
193 131 097	238
193 131 107	238
193 131 117	238
193 131 127	238
193 131 147	238
193 131 157	238
193 355 202	191
198 037 000	153
198 037 001	153
198 037 010	153
198 037 011	153
198 037 020	152
198 037 021	152
198 037 030	152
198 037 031	152
198 335 000	194
198 335 001	194
198 335 002	194
198 335 003	194
198 335 004	194
198 335 005	194
198 335 006	194
198 335 007	194
198 335 008	194
198 335 009	194
198 335 010	194
198 335 011	194
198 335 012	194
198 335 020	194
198 335 021	194
198 335 022	194
198 335 023	194
198 335 024	194
198 335 025	194

Code	Page
198 335 026	194
198 335 027	194
198 335 028	194
198 335 029	194
198 335 030	194
198 335 031	194
198 335 032	194
198 335 040	194
198 335 041	194
198 335 042	194
198 335 043	194
198 335 044	194
198 335 045	194
198 335 046	194
198 335 047	194
198 335 048	194
198 335 049	194
198 335 050	194
198 335 051	194
198 335 052	194
198 335 100	195
198 335 101	195
198 335 102	195
198 335 103	195
198 335 104	195
198 335 105	195
198 335 106	195
198 335 107	195
198 335 108	195
198 335 109	195
198 335 110	195
198 335 111	195
198 335 112	195
198 335 120	195
198 335 121	195
198 335 122	195
198 335 123	195
198 335 124	195
198 335 125	195
198 335 126	195
198 335 127	195
198 335 128	195
198 335 129	195
198 335 130	195
198 335 131	195
198 335 132	195
198 335 140	195
198 335 141	195
198 335 142	195
198 335 143	195
198 335 144	195
198 335 145	195

Code	Page
198 335 146	195
198 335 147	195
198 335 148	195
198 335 149	195
198 335 150	195
198 335 151	195
198 335 152	195
198 335 400	190
198 335 401	190
198 335 402	190
198 335 403	190
198 335 404	190
198 335 405	190
198 335 406	190
198 335 407	190
198 335 408	190
198 335 409	190
198 335 410	190
198 335 411	190
198 335 412	190
198 335 420	190
198 335 421	190
198 335 422	190
198 335 423	190
198 335 424	190
198 335 425	190
198 335 426	190
198 335 427	190
198 335 428	190
198 335 429	190
198 335 430	190
198 335 431	190
198 335 432	190
198 335 440	190
198 335 441	190
198 335 442	190
198 335 443	190
198 335 444	190
198 335 445	190
198 335 446	190
198 335 447	190
198 335 448	190
198 335 449	190
198 335 450	190
198 335 451	190
198 335 452	190
198 335 500	191
198 335 501	191
198 335 502	191
198 335 503	191
198 335 504	191
198 335 505	191

Index

Code	Page
198 335 506	191
198 335 507	191
198 335 508	191
198 335 509	191
198 335 510	191
198 335 511	191
198 335 512	191
198 335 520	191
198 335 521	191
198 335 523	191
198 335 524	191
198 335 525	191
198 335 526	191
198 335 527	191
198 335 528	191
198 335 529	191
198 335 530	191
198 335 531	191
198 335 532	191
198 335 540	191
198 335 541	191
198 335 542	191
198 335 543	191
198 335 544	191
198 335 545	191
198 335 546	191
198 335 547	191
198 335 548	191
198 335 549	191
198 335 550	192
198 335 551	192
198 335 552	192
198 335 960	198
198 335 961	198
198 335 962	198
198 335 963	198
198 335 964	198
198 335 965	198
198 335 966	198
198 335 967	198
198 335 968	198
198 335 969	198
198 335 991	198
198 335 992	198
198 335 993	198
198 335 994	198
198 335 995	198
198 801 880	196
198 801 881	196
198 801 882	196
198 801 883	196
198 801 884	196

Code	Page
198 801 885	196
198 801 886	196
198 801 887	196
198 801 888	196
198 801 889	196
198 801 890	197
198 801 891	197
198 801 892	197
198 801 893	197
198 801 894	197
198 801 895	197
198 801 896	197
198 801 897	197
198 801 898	197
198 801 899	197
198 803 310	196
198 803 311	196
198 803 312	196
198 803 313	196
198 803 314	196
198 803 315	196
198 803 316	196
198 803 317	196
198 803 318	196
198 803 319	196
198 803 320	197
198 803 321	197
198 803 322	197
198 803 323	197
198 803 324	197
198 803 325	197
198 803 326	197
198 803 327	197
198 803 328	197
198 803 329	197
198 807 000	192
198 807 001	192
198 807 002	192
198 807 003	192
198 807 004	192
198 807 005	192
198 807 006	192
198 807 007	192
198 807 008	192
198 807 009	192
198 807 010	193
198 807 011	193
198 807 012	193
198 807 013	193
198 807 014	193
198 807 015	193
198 807 016	193

Code	Page
198 807 017	193
198 807 018	193
198 807 019	193
198 820 900	201
198 820 901	201
198 820 902	201
198 820 903	201
198 820 904	201
198 820 905	201
198 820 906	201
198 820 907	201
198 820 908	201
198 820 909	201
198 820 910	201
198 820 911	201
198 820 912	201
198 820 913	201
198 820 914	201
198 820 915	201
198 820 916	201
198 820 918	201
198 820 919	201
198 820 920	201
198 820 921	201
198 820 950	200
198 820 951	200
198 820 952	200
198 820 953	200
198 820 954	200
198 820 955	200
198 820 956	200
198 820 957	200
198 820 958	200
198 820 959	200
198 820 960	200
198 820 961	200
198 820 962	200
198 820 963	200
198 820 964	200
198 820 965	200
198 820 966	200
198 820 968	200
198 820 969	200
198 820 970	200
198 820 971	200
198 820 980	199
198 820 981	199
198 820 982	199
198 820 983	199
198 820 984	199
198 820 985	199
198 820 986	199

Index

Code	Page
198 820 987	199
198 820 988	199
198 820 989	199
198 820 990	199
198 820 991	199
198 820 992	199
198 820 993	199
198 820 994	199
198 820 995	199
198 820 996	199
198 820 998	199
198 820 999	199
198 821 000	199
198 821 001	199
199 037 000	150
199 037 001	150
199 037 002	150
199 037 003	150
199 037 004	150
199 037 005	150
199 037 006	150
199 037 007	150
199 037 008	150
199 037 013	150
199 037 014	150
199 037 015	150
199 037 016	150
199 037 017	150
199 037 018	150
199 037 019	150
199 037 020	150
199 037 021	150
199 037 026	151
199 037 027	151
199 037 028	151
199 037 029	151
199 037 030	151
199 037 031	151
199 037 032	151
199 037 033	151
199 037 034	151
199 037 039	151
199 037 040	151
199 037 041	151
199 037 042	151
199 037 043	151
199 037 044	151
199 037 045	151
199 037 046	151
199 037 047	151
199 037 200	150
199 037 201	150

Code	Page
199 037 202	150
199 037 203	150
199 037 204	150
199 037 205	150
199 037 206	150
199 037 207	150
199 037 208	150
199 037 213	150
199 037 214	150
199 037 215	150
199 037 216	150
199 037 217	150
199 037 218	150
199 037 219	150
199 037 220	150
199 037 221	150
199 037 226	151
199 037 227	151
199 037 228	151
199 037 229	151
199 037 230	151
199 037 231	151
199 037 232	151
199 037 233	151
199 037 234	151
199 037 239	151
199 037 240	151
199 037 241	151
199 037 242	151
199 037 243	151
199 037 244	151
199 037 245	151
199 037 246	151
199 037 247	151
199 037 400	150
199 037 401	150
199 037 402	150
199 037 403	150
199 037 404	150
199 037 405	150
199 037 406	150
199 037 407	150
199 037 408	150
199 037 413	150
199 037 414	150
199 037 415	150
199 037 416	150
199 037 417	150
199 037 418	150
199 037 419	150
199 037 420	150
199 037 421	150

Code	Page
199 037 426	151
199 037 427	151
199 037 428	151
199 037 429	151
199 037 430	151
199 037 431	151
199 037 432	151
199 037 433	151
199 037 434	151
199 037 439	152
199 037 440	152
199 037 441	152
199 037 442	152
199 037 443	152
199 037 444	152
199 037 445	152
199 037 446	152
199 037 447	152
199 038 000	154
199 038 001	154
199 038 002	154
199 038 003	154
199 038 004	154
199 038 005	154
199 038 006	154
199 038 007	154
199 038 008	154
199 038 013	154
199 038 014	154
199 038 015	154
199 038 016	154
199 038 017	154
199 038 018	154
199 038 019	154
199 038 020	154
199 038 021	154
199 038 026	156
199 038 027	156
199 038 028	156
199 038 029	156
199 038 030	156
199 038 031	156
199 038 032	156
199 038 033	156
199 038 034	156
199 038 039	156
199 038 040	156
199 038 041	156
199 038 042	156
199 038 043	156
199 038 044	156
199 038 045	156

Index

Code	Page
199 038 046	156
199 038 047	156
199 038 200	154
199 038 201	154
199 038 202	154
199 038 203	154
199 038 204	154
199 038 205	154
199 038 206	155
199 038 207	155
199 038 208	155
199 038 213	154
199 038 214	154
199 038 215	154
199 038 216	154
199 038 217	154
199 038 218	154
199 038 219	155
199 038 220	155
199 038 221	155
199 038 226	156
199 038 227	156
199 038 228	156
199 038 229	156
199 038 230	156
199 038 231	156
199 038 232	156
199 038 233	156
199 038 234	156
199 038 239	156
199 038 240	156
199 038 241	156
199 038 242	156
199 038 243	156
199 038 244	156
199 038 245	156
199 038 246	156
199 038 247	156
199 038 400	155
199 038 401	155
199 038 402	155
199 038 403	155
199 038 404	155
199 038 405	155
199 038 406	155
199 038 407	155
199 038 408	155
199 038 413	155
199 038 414	155
199 038 415	155
199 038 416	155
199 038 417	155

Code	Page
199 038 418	155
199 038 419	155
199 038 420	155
199 038 421	155
199 038 426	156
199 038 427	156
199 038 428	156
199 038 429	156
199 038 430	156
199 038 431	156
199 038 432	156
199 038 433	156
199 038 434	156
199 038 439	156
199 038 440	156
199 038 441	156
199 038 442	157
199 038 443	157
199 038 444	157
199 038 445	157
199 038 446	157
199 038 447	157
199 041 000	189
199 041 001	189
199 041 006	189
199 041 007	189
199 041 012	186
199 041 013	186
199 041 014	186
199 041 015	186
199 041 016	186
199 041 017	186
199 041 018	186
199 041 019	186
199 041 020	186
199 041 021	186
199 041 022	186
199 041 023	186
199 041 024	186
199 041 025	186
199 041 026	186
199 041 027	186
199 041 028	186
199 041 029	186
199 041 030	186
199 041 031	186
199 041 060	186
199 041 061	186
199 041 062	186
199 041 063	186
199 041 064	186
199 041 065	186

Code	Page
199 041 066	186
199 041 067	186
199 041 068	186
199 041 069	186
199 041 070	186
199 041 071	186
199 041 292	189
199 041 293	189
199 041 309	188
199 041 310	188
199 041 311	188
199 041 312	188
199 041 313	188
199 041 314	188
199 041 315	188
199 041 330	187
199 041 331	187
199 041 332	187
199 041 333	187
199 041 334	187
199 041 335	187
199 041 336	187
199 041 360	187
199 041 361	187
199 041 362	187
199 041 363	187
199 041 364	187
199 041 365	187
199 041 366	187
199 041 379	188
199 041 380	188
199 041 381	188
199 041 382	188
199 041 383	188
199 041 384	188
199 041 385	188
199 041 914	187
199 041 919	187
199 041 922	188
199 041 940	187
199 041 944	188
199 041 945	188
199 041 950	188
199 041 953	188
199 041 984	187
199 041 985	187
199 041 986	187
199 041 987	188
199 041 988	188
199 041 989	188
199 041 990	188
199 041 991	188

Index

Code	Page	Code	Page	Code	Page
324 110 000	34	325 063 001	38	700 238 451	235
324 125 000	34	325 063 002	39	700 238 452	235
324 140 000	34	325 063 003	37	700 238 453	235
324 160 000	34	325 075 000	38	700 238 454	235
324 160 001	34	325 075 001	38	700 238 456	235
324 180 000	34	325 075 002	37	700 238 457	235
324 180 001	34	325 090 000	38	700 244 652	245
324 200 000	34	325 090 001	38	720 600 236	77
324 200 001	35	325 090 002	37	720 600 237	77
324 210 000	35	325 110 000	37	720 600 238	77
324 225 000	34	325 110 001	38	720 600 239	77
324 225 001	35	325 110 002	38	720 600 240	77
324 250 000	34	325 110 003	37	720 600 241	77
324 250 002	35	325 140 000	38	720 600 242	77
324 260 000	35	325 160 000	37	720 600 243	77
324 280 000	34	325 160 001	38	720 600 246	78
324 280 001	35	325 225 000	38	720 600 247	78
324 315 000	34	325 315 000	37	720 600 248	78
324 315 001	35	700 238 043	237	720 600 249	78
324 355 000	34	700 238 046	237	720 600 250	78
324 355 001	35	700 238 047	237	720 600 251	78
324 400 000	34	700 238 049	237	720 600 252	78
324 400 001	35	700 238 053	237	720 600 253	78
324 450 000	34	700 238 054	237	720 600 257	78
324 450 001	35	700 238 060	237	720 600 258	78
324 500 000	34	700 238 061	237	720 600 268	78
324 500 001	35	700 238 062	237	720 690 005	80
324 600 000	35	700 238 064	237	720 690 006	80
325 010 000	39	700 238 065	237	720 690 007	80
325 012 000	38	700 238 068	237	720 690 008	80
325 016 000	37	700 238 070	237	720 690 009	80
325 016 001	38	700 238 071	237	720 690 010	80
325 016 002	39	700 238 424	236	720 690 011	80
325 020 000	37	700 238 425	236	720 690 012	80
325 020 001	38	700 238 426	236	720 690 405	80
325 020 002	39	700 238 427	236	720 910 206	55
325 025 000	37	700 238 428	236	720 910 207	55
325 025 001	39	700 238 429	236	720 910 208	55
325 025 002	38	700 238 430	236	720 910 209	55
325 032 000	38	700 238 431	236	720 910 210	55
325 032 001	38	700 238 432	236	720 910 211	55
325 032 002	39	700 238 433	236	720 910 706	55
325 032 003	37	700 238 434	236	720 910 707	55
325 040 000	38	700 238 436	236	720 910 708	55
325 040 001	38	700 238 437	236	720 910 709	55
325 040 002	39	700 238 444	235	720 910 710	55
325 040 003	37	700 238 445	235	720 910 711	55
325 050 000	38	700 238 446	235	721 000 106	40
325 050 001	38	700 238 447	235	721 000 107	40
325 050 002	39	700 238 448	235	721 000 108	40
325 050 003	37	700 238 449	235	721 000 109	40
325 063 000	38	700 238 450	235	721 000 110	40

Index

Code	Page
721 000 111	40
721 000 112	6
721 000 113	40
721 000 114	40
721 000 116	6
721 000 117	40
721 001 106	6
721 001 107	6
721 001 108	6
721 001 109	6
721 001 110	6
721 001 111	6
721 001 113	6
721 001 115	6
721 001 117	6
721 010 120	40
721 010 122	40
721 010 123	40
721 010 125	40
721 011 120	6
721 100 101	40
721 100 102	40
721 100 103	40
721 100 104	40
721 100 105	40
721 100 106	40
721 100 107	40
721 100 108	40
721 100 109	40
721 100 110	40
721 100 111	40
721 100 112	6
721 100 113	40
721 100 114	40
721 100 115	41
721 100 116	6
721 100 117	41
721 100 119	41
721 100 120	41
721 100 121	41
721 100 204	50
721 100 205	50
721 100 206	50
721 100 207	50
721 100 208	50
721 100 209	50
721 100 210	50
721 100 211	50
721 100 212	50
721 100 213	50
721 100 214	50
721 100 306	41

Code	Page
721 100 307	41
721 100 308	41
721 100 309	41
721 100 310	41
721 100 311	41
721 101 105	6
721 101 106	6
721 101 107	6
721 101 108	6
721 101 109	6
721 101 110	6
721 101 111	6
721 101 113	6
721 101 115	6
721 101 117	6
721 101 206	13
721 101 207	13
721 101 208	13
721 101 605	57
721 101 606	57
721 101 607	57
721 101 608	57
721 101 609	57
721 101 610	57
721 101 611	57
721 104 106	246
721 104 107	246
721 104 108	246
721 104 109	246
721 104 110	246
721 104 111	246
721 104 112	246
721 104 113	246
721 104 114	246
721 104 115	246
721 104 116	246
721 104 117	246
721 104 119	246
721 104 120	246
721 104 156	246
721 104 157	246
721 104 158	246
721 104 159	246
721 104 160	246
721 104 161	246
721 104 162	246
721 104 163	246
721 104 164	246
721 150 105	41
721 150 106	41
721 150 107	41
721 150 108	41

Code	Page
721 150 109	41
721 150 110	41
721 150 111	41
721 150 112	7
721 150 113	41
721 150 114	41
721 150 115	41
721 150 116	7
721 150 117	41
721 150 119	41
721 150 120	41
721 150 121	41
721 150 122	41
721 150 123	41
721 150 125	41
721 150 306	42
721 150 307	42
721 150 308	42
721 150 309	42
721 150 310	42
721 150 311	42
721 151 105	7
721 151 106	7
721 151 107	7
721 151 108	7
721 151 109	7
721 151 110	7
721 151 111	7
721 151 113	7
721 151 115	7
721 151 117	7
721 151 120	7
721 154 106	246
721 154 107	246
721 154 108	246
721 154 109	246
721 154 110	246
721 154 111	246
721 154 112	246
721 154 113	246
721 154 114	246
721 154 115	246
721 154 116	247
721 154 117	247
721 154 119	247
721 154 120	247
721 154 156	246
721 154 157	246
721 154 158	246
721 154 159	246
721 154 160	246
721 154 161	246

Index

Code	Page
721 154 162	246
721 154 163	246
721 154 164	246
721 200 009	43
721 200 010	43
721 200 011	43
721 200 101	42
721 200 102	42
721 200 103	42
721 200 104	42
721 200 105	42
721 200 106	42
721 200 107	42
721 200 108	42
721 200 109	42
721 200 110	42
721 200 111	42
721 200 112	7
721 200 113	42
721 200 114	42
721 200 115	42
721 200 116	7
721 200 117	42
721 200 119	42
721 200 120	42
721 200 121	42
721 200 122	42
721 200 123	42
721 200 125	42
721 200 132	43
721 200 134	43
721 200 135	43
721 200 136	43
721 200 137	43
721 200 138	43
721 200 139	43
721 200 140	43
721 200 141	43
721 200 142	43
721 200 144	43
721 200 145	43
721 200 146	43
721 200 147	43
721 200 148	43
721 200 149	8
721 200 150	44
721 200 151	43
721 200 152	44
721 200 153	44
721 200 154	44
721 200 155	43
721 200 156	44

Code	Page
721 200 157	44
721 200 159	44
721 200 161	43
721 200 162	44
721 200 164	43
721 200 165	44
721 200 167	44
721 200 169	44
721 200 170	43
721 200 172	44
721 200 174	43
721 200 176	44
721 200 178	43
721 200 180	44
721 200 181	43
721 200 182	43
721 200 183	43
721 200 184	43
721 200 204	50
721 200 205	50
721 200 206	50
721 200 207	50
721 200 208	50
721 200 209	50
721 200 210	50
721 200 211	50
721 200 212	50
721 200 213	50
721 200 214	50
721 200 306	43
721 200 307	43
721 200 308	43
721 200 309	43
721 200 310	43
721 200 311	43
721 201 009	8
721 201 010	8
721 201 011	8
721 201 105	7
721 201 106	7
721 201 107	7
721 201 108	7
721 201 109	7
721 201 110	7
721 201 111	7
721 201 113	7
721 201 115	7
721 201 117	7
721 201 120	7
721 201 134	8
721 201 137	8
721 201 138	8

Code	Page
721 201 141	8
721 201 147	8
721 201 151	8
721 201 164	8
721 201 170	8
721 201 178	8
721 201 205	13
721 201 206	13
721 201 207	13
721 201 208	13
721 201 605	57
721 201 606	57
721 201 607	57
721 201 608	57
721 201 609	57
721 201 610	57
721 201 611	57
721 204 106	247
721 204 107	247
721 204 108	247
721 204 109	247
721 204 110	247
721 204 111	247
721 204 112	247
721 204 113	247
721 204 114	247
721 204 115	247
721 204 116	247
721 204 117	247
721 204 119	247
721 204 120	247
721 204 156	247
721 204 157	247
721 204 158	247
721 204 159	247
721 204 160	247
721 204 161	247
721 204 162	247
721 204 163	247
721 204 164	247
721 239 106	249
721 239 107	249
721 239 108	249
721 239 109	249
721 239 110	249
721 239 111	249
721 239 126	249
721 239 127	249
721 239 128	249
721 239 129	249
721 239 130	249
721 239 131	249

Index

Code	Page
721 239 156	249
721 239 157	249
721 239 158	249
721 239 159	249
721 239 160	249
721 239 161	249
721 239 176	249
721 239 177	249
721 239 178	249
721 239 179	249
721 239 180	249
721 239 181	249
721 240 106	250
721 240 107	250
721 240 108	250
721 240 109	250
721 240 110	250
721 240 111	250
721 240 126	250
721 240 127	250
721 240 128	250
721 240 129	250
721 240 130	250
721 240 131	250
721 240 156	250
721 240 157	250
721 240 158	250
721 240 159	250
721 240 160	250
721 240 161	250
721 240 176	250
721 240 177	250
721 240 178	250
721 240 179	250
721 240 180	250
721 240 181	250
721 250 103	44
721 250 104	44
721 250 105	44
721 250 106	44
721 250 107	44
721 250 108	44
721 250 109	44
721 250 110	44
721 250 111	44
721 250 112	8
721 250 113	44
721 250 114	44
721 250 115	44
721 250 116	8
721 250 117	44
721 250 119	44

Code	Page
721 250 120	44
721 250 121	44
721 251 106	8
721 251 107	8
721 251 108	8
721 251 109	8
721 251 110	8
721 251 111	8
721 251 113	8
721 251 115	8
721 300 103	45
721 300 104	45
721 300 105	45
721 300 106	45
721 300 107	45
721 300 108	45
721 300 109	45
721 300 110	45
721 300 111	45
721 300 112	9
721 300 113	45
721 300 114	45
721 301 107	9
721 301 108	9
721 301 109	9
721 301 110	9
721 301 111	9
721 500 103	73
721 500 104	73
721 500 105	73
721 500 106	73
721 500 107	73
721 500 108	73
721 500 109	73
721 500 110	73
721 500 111	73
721 500 162	73
721 500 163	73
721 500 164	73
721 500 405	74
721 500 406	74
721 500 407	74
721 500 408	74
721 500 409	74
721 500 410	74
721 500 411	74
721 510 003	65
721 510 004	65
721 510 005	65
721 510 006	65
721 510 007	65
721 510 008	65

Code	Page
721 510 009	65
721 510 010	65
721 510 011	65
721 510 012	65
721 510 014	65
721 510 028	65
721 510 029	65
721 510 030	65
721 510 031	65
721 510 032	65
721 510 033	65
721 510 034	65
721 510 035	65
721 510 036	65
721 510 037	65
721 510 039	65
721 510 103	64
721 510 104	64
721 510 105	64
721 510 106	64
721 510 107	64
721 510 108	64
721 510 109	64
721 510 110	64
721 510 111	64
721 510 112	22
721 510 114	64
721 510 128	64
721 510 129	64
721 510 130	64
721 510 131	64
721 510 132	64
721 510 133	64
721 510 134	64
721 510 135	64
721 510 136	64
721 510 137	22
721 510 139	64
721 510 204	67
721 510 205	67
721 510 206	67
721 510 207	67
721 510 208	67
721 510 209	68
721 510 210	68
721 510 211	68
721 510 213	65
721 510 238	65
721 510 305	65
721 510 306	65
721 510 307	65
721 510 308	65

Index

Code	Page
721 510 309	65
721 510 310	65
721 510 311	65
721 510 313	64
721 510 330	65
721 510 331	65
721 510 332	65
721 510 333	65
721 510 334	65
721 510 335	65
721 510 336	65
721 510 338	64
721 510 405	68
721 510 406	68
721 510 407	68
721 510 408	68
721 510 409	68
721 510 410	68
721 510 411	68
721 510 604	66
721 510 605	66
721 510 606	66
721 510 607	66
721 510 608	66
721 510 609	66
721 510 610	66
721 510 611	66
721 511 105	22
721 511 106	22
721 511 107	22
721 511 108	22
721 511 109	22
721 511 110	22
721 511 111	22
721 511 130	22
721 511 131	22
721 511 132	22
721 511 133	22
721 511 134	22
721 511 135	22
721 511 136	22
721 511 205	23
721 511 206	23
721 511 207	23
721 511 208	23
721 511 209	23
721 511 210	23
721 511 211	23
721 513 105	25
721 513 106	25
721 513 107	25
721 513 108	25

Code	Page
721 513 109	25
721 513 110	25
721 513 111	25
721 514 105	67
721 514 106	67
721 514 107	67
721 514 108	67
721 514 109	67
721 514 110	67
721 514 111	67
721 514 205	68
721 514 206	68
721 514 207	68
721 514 208	68
721 514 209	68
721 514 210	68
721 514 211	68
721 530 306	70
721 530 307	70
721 530 308	70
721 530 309	70
721 530 310	70
721 530 311	70
721 530 312	23
721 530 313	70
721 530 806	71
721 530 807	71
721 530 808	71
721 530 809	71
721 530 810	71
721 530 811	71
721 530 812	24
721 530 813	71
721 531 306	23
721 531 307	23
721 531 308	23
721 531 309	23
721 531 310	23
721 531 311	23
721 531 313	23
721 531 806	24
721 531 807	24
721 531 808	24
721 531 809	24
721 531 810	24
721 531 811	24
721 531 813	24
721 540 205	69
721 540 206	69
721 540 207	69
721 540 208	69
721 540 209	69

Code	Page
721 540 210	69
721 540 211	69
721 540 230	69
721 540 231	69
721 540 232	69
721 540 233	69
721 540 234	69
721 540 235	69
721 540 236	69
721 540 705	69
721 540 706	69
721 540 707	69
721 540 708	69
721 540 709	69
721 540 710	69
721 540 711	69
721 540 730	69
721 540 731	69
721 540 732	69
721 540 733	69
721 540 734	69
721 540 735	69
721 540 736	69
721 545 505	70
721 545 506	70
721 545 507	70
721 545 508	70
721 545 509	70
721 545 510	70
721 545 511	70
721 545 530	70
721 545 531	70
721 545 532	70
721 545 533	70
721 545 534	70
721 545 535	70
721 545 536	70
721 550 305	72
721 550 306	72
721 550 307	72
721 550 506	71
721 550 507	71
721 550 508	71
721 550 509	71
721 550 510	71
721 550 511	71
721 550 512	24
721 550 513	71
721 550 906	72
721 550 907	72
721 550 908	72
721 550 909	72

Index

Code	Page
721 550 910	72
721 550 911	72
721 550 912	25
721 550 913	72
721 550 957	72
721 550 958	72
721 550 967	72
721 550 968	72
721 551 405	17
721 551 406	17
721 551 506	24
721 551 507	24
721 551 508	24
721 551 509	24
721 551 510	24
721 551 511	24
721 551 513	24
721 551 906	25
721 551 907	25
721 551 908	25
721 551 909	25
721 551 910	25
721 551 911	25
721 551 913	25
721 600 004	75
721 600 005	75
721 600 006	75
721 600 007	75
721 600 008	75
721 600 009	75
721 600 010	75
721 600 011	75
721 600 012	75
721 600 013	75
721 600 014	75
721 600 112	73
721 600 113	73
721 600 305	74
721 600 306	74
721 600 307	74
721 600 654	75
721 600 655	75
721 600 656	75
721 600 657	75
721 600 658	75
721 600 659	75
721 600 660	75
721 600 661	75
721 601 105	73
721 601 106	73
721 601 107	73
721 601 108	73

Code	Page
721 601 109	73
721 601 110	73
721 601 111	73
721 601 113	73
721 602 005	74
721 602 006	74
721 602 007	74
721 602 008	74
721 602 009	74
721 602 010	74
721 602 011	74
721 602 012	74
721 602 013	74
721 602 014	74
721 602 655	75
721 602 656	75
721 602 657	75
721 602 658	75
721 602 659	75
721 602 660	75
721 602 661	75
721 700 005	216
721 700 006	216
721 700 007	216
721 700 008	216
721 700 009	216
721 700 010	216
721 700 011	216
721 700 012	216
721 700 013	216
721 700 014	216
721 700 015	216
721 700 016	216
721 700 019	216
721 700 020	216
721 700 021	216
721 700 136	216
721 700 137	216
721 700 138	216
721 700 139	216
721 700 140	216
721 700 506	223
721 700 507	223
721 700 508	223
721 700 509	223
721 700 510	223
721 700 511	223
721 700 512	223
721 700 513	223
721 700 514	223
721 700 516	223
721 700 517	223

Code	Page
721 700 520	223
721 700 521	223
721 700 522	223
721 700 523	223
721 700 524	223
721 700 525	223
721 701 006	223
721 701 007	223
721 701 008	223
721 701 009	223
721 701 010	223
721 701 011	223
721 701 013	223
721 701 015	223
721 701 017	223
721 701 106	222
721 701 107	222
721 701 108	222
721 701 109	222
721 701 110	222
721 701 111	222
721 701 113	222
721 701 115	222
721 701 117	222
721 701 206	222
721 701 207	222
721 701 208	222
721 701 209	222
721 701 210	222
721 701 211	222
721 701 213	222
721 701 214	222
721 701 215	222
721 701 217	222
721 702 206	217
721 702 207	217
721 702 208	217
721 702 209	217
721 702 210	217
721 702 211	217
721 702 212	217
721 702 213	217
721 702 214	217
721 702 216	217
721 702 217	217
721 702 220	217
721 702 306	222
721 702 307	222
721 702 308	222
721 702 309	222
721 702 310	222
721 702 311	222

Index

Code	Page
721 702 313	222
721 702 315	222
721 702 317	222
721 730 006	21
721 730 007	21
721 730 008	21
721 730 009	21
721 730 010	21
721 730 011	21
721 730 013	21
721 730 014	21
721 730 017	21
721 730 109	20
721 730 110	20
721 730 111	20
721 730 113	20
721 730 117	20
721 731 106	19
721 731 107	19
721 731 108	19
721 731 109	19
721 731 110	19
721 731 111	19
721 731 113	19
721 731 114	19
721 731 117	19
721 732 106	20
721 732 107	20
721 732 108	20
721 732 111	20
721 732 113	20
721 732 114	20
721 740 106	62
721 740 107	62
721 740 108	62
721 740 109	63
721 740 110	63
721 740 111	63
721 740 112	63
721 740 113	63
721 740 114	63
721 740 116	63
721 740 117	63
721 790 111	61
721 790 112	19
721 790 113	61
721 790 114	61
721 790 115	61
721 790 116	19
721 790 117	61
721 790 119	61
721 790 120	61

Code	Page
721 790 121	61
721 790 122	61
721 790 123	61
721 790 124	61
721 790 125	61
721 791 106	19
721 791 107	19
721 791 108	19
721 791 109	19
721 791 110	19
721 791 111	19
721 791 113	19
721 791 115	19
721 791 117	19
721 791 120	19
721 791 122	19
721 791 123	19
721 800 105	61
721 800 106	61
721 800 107	61
721 800 108	61
721 800 109	61
721 800 110	61
721 810 105	62
721 810 106	62
721 810 107	62
721 810 108	62
721 810 109	62
721 810 110	62
721 810 111	62
721 810 112	62
721 810 113	62
721 810 114	62
721 810 115	62
721 810 116	62
721 810 117	62
721 810 119	62
721 810 120	62
721 810 121	62
721 810 122	62
721 810 123	62
721 840 103	79
721 840 104	79
721 840 105	79
721 840 106	79
721 840 107	79
721 840 108	79
721 840 109	79
721 840 110	79
721 840 111	79
721 840 112	79
721 840 114	79

Code	Page
721 840 123	79
721 840 604	79
721 840 605	79
721 840 606	79
721 840 607	79
721 840 608	79
721 840 609	79
721 840 610	79
721 840 611	79
721 841 105	79
721 841 106	79
721 841 107	79
721 841 108	79
721 841 109	79
721 841 110	79
721 841 111	79
721 890 004	80
721 890 005	80
721 890 006	80
721 890 007	80
721 890 008	80
721 890 009	80
721 890 010	80
721 890 011	80
721 890 012	80
721 890 013	80
721 890 014	80
721 890 023	80
721 900 181	47
721 900 300	47
721 900 301	47
721 900 302	47
721 900 303	47
721 900 304	48
721 900 305	48
721 900 306	48
721 900 307	48
721 900 308	48
721 900 309	48
721 900 310	48
721 900 311	48
721 900 312	48
721 900 313	48
721 900 315	48
721 900 319	48
721 900 320	48
721 900 321	48
721 900 322	48
721 900 325	47
721 900 326	47
721 900 329	47
721 900 331	47

Index

Code	Page
721 900 334	47
721 900 337	47
721 900 341	47
721 900 342	47
721 900 346	47
721 900 347	47
721 900 348	47
721 900 352	47
721 900 353	47
721 900 354	47
721 900 355	47
721 900 358	47
721 900 359	47
721 900 360	47
721 900 364	47
721 900 365	47
721 900 370	47
721 900 371	47
721 900 372	47
721 900 376	47
721 900 377	47
721 900 378	47
721 900 379	47
721 900 380	47
721 900 381	47
721 900 384	47
721 900 385	47
721 900 386	47
721 900 388	47
721 900 390	47
721 900 391	47
721 900 392	47
721 900 393	47
721 900 394	47
721 900 396	47
721 900 397	47
721 900 398	47
721 900 399	47
721 900 406	52
721 900 407	52
721 900 408	52
721 900 409	52
721 900 410	52
721 900 411	52
721 900 905	46
721 900 906	46
721 900 907	46
721 900 908	46
721 900 909	46
721 900 910	46
721 900 911	46
721 900 912	10

Code	Page
721 900 913	46
721 900 914	46
721 900 915	46
721 900 916	10
721 900 917	46
721 900 919	46
721 900 920	46
721 901 334	10
721 901 337	10
721 901 338	10
721 901 341	10
721 901 342	10
721 901 343	10
721 901 346	10
721 901 347	10
721 901 348	10
721 901 349	10
721 901 352	10
721 901 353	10
721 901 354	10
721 901 355	10
721 901 358	10
721 901 359	10
721 901 360	10
721 901 361	10
721 901 364	10
721 901 370	10
721 901 371	10
721 901 372	10
721 901 374	10
721 901 381	10
721 901 384	10
721 901 388	10
721 901 396	10
721 901 406	13
721 901 407	13
721 901 408	13
721 901 409	13
721 901 410	13
721 901 411	13
721 901 534	15
721 901 537	15
721 901 541	15
721 901 542	15
721 901 905	9
721 901 906	9
721 901 907	9
721 901 908	9
721 901 909	9
721 901 910	9
721 901 911	10
721 901 913	10

Code	Page
721 901 914	10
721 910 101	45
721 910 102	45
721 910 103	45
721 910 104	45
721 910 105	45
721 910 106	45
721 910 107	45
721 910 108	45
721 910 109	45
721 910 110	45
721 910 111	45
721 910 112	9
721 910 113	45
721 910 114	45
721 910 115	45
721 910 116	9
721 910 117	45
721 910 119	45
721 910 120	45
721 910 121	45
721 910 122	45
721 910 123	45
721 910 124	45
721 910 125	45
721 910 204	51
721 910 205	51
721 910 206	51
721 910 207	51
721 910 208	51
721 910 209	51
721 910 210	51
721 910 211	51
721 910 323	48
721 910 325	48
721 910 326	48
721 910 334	48
721 910 337	48
721 910 341	48
721 910 346	48
721 910 352	48
721 910 358	48
721 910 364	48
721 910 370	48
721 910 385	48
721 910 404	52
721 910 434	52
721 910 437	52
721 910 441	52
721 910 446	52
721 910 452	52
721 910 458	52

Index

Code	Page
721 910 555	52
721 910 556	52
721 910 557	52
721 910 558	52
721 910 559	52
721 910 560	52
721 910 561	52
721 910 604	57
721 910 605	57
721 910 606	57
721 910 607	57
721 910 608	57
721 910 609	58
721 910 610	58
721 910 611	58
721 910 705	53
721 910 706	53
721 910 707	53
721 910 708	53
721 910 709	53
721 910 710	53
721 910 711	53
721 910 712	14
721 910 713	53
721 910 714	53
721 910 834	58
721 910 837	58
721 910 841	58
721 910 842	58
721 910 846	58
721 910 852	58
721 910 858	58
721 910 903	48
721 910 905	48
721 910 906	48
721 910 908	48
721 910 909	48
721 910 910	48
721 910 911	48
721 910 912	48
721 910 913	48
721 910 914	48
721 910 915	48
721 910 916	48
721 910 917	49
721 910 918	49
721 910 919	49
721 910 920	49
721 910 921	49
721 910 922	49
721 910 923	49
721 910 924	49

Code	Page
721 910 925	49
721 910 926	49
721 910 927	49
721 910 928	49
721 910 929	49
721 911 005	16
721 911 006	16
721 911 007	16
721 911 008	16
721 911 009	16
721 911 010	16
721 911 011	16
721 911 105	9
721 911 106	9
721 911 107	9
721 911 108	9
721 911 109	9
721 911 110	9
721 911 111	9
721 911 113	9
721 911 115	9
721 911 117	9
721 911 120	9
721 911 386	11
721 911 389	11
721 911 434	14
721 911 505	59
721 911 506	59
721 911 507	59
721 911 508	59
721 911 509	59
721 911 510	59
721 911 511	59
721 911 513	59
721 911 515	59
721 911 555	15
721 911 556	15
721 911 557	15
721 911 558	15
721 911 705	14
721 911 706	14
721 911 707	14
721 911 708	14
721 911 709	14
721 911 710	14
721 911 711	14
721 911 737	15
721 911 741	15
721 911 746	15
721 911 752	15
721 911 758	15
721 911 905	58

Code	Page
721 911 906	58
721 911 907	58
721 911 908	58
721 911 909	58
721 911 910	58
721 911 911	58
721 913 105	17
721 913 106	17
721 913 107	17
721 913 108	17
721 913 109	17
721 913 110	17
721 913 111	17
721 913 113	17
721 913 115	17
721 913 505	53
721 913 506	53
721 913 507	53
721 913 508	53
721 913 905	16
721 913 906	16
721 913 907	16
721 913 908	16
721 913 909	16
721 913 910	16
721 913 911	16
721 913 913	16
721 913 915	16
721 914 206	51
721 914 207	51
721 914 208	51
721 914 209	51
721 914 210	51
721 914 211	51
721 914 212	51
721 914 213	51
721 914 214	51
721 916 012	51
721 916 013	51
721 916 014	51
721 916 204	55
721 916 206	55
721 940 106	54
721 940 107	54
721 940 108	54
721 940 606	54
721 940 607	54
721 940 608	54
721 950 106	54
721 950 107	54
721 950 108	54
721 950 606	54

Index

Code	Page
721 950 607	54
721 950 608	54
721 960 104	49
721 960 105	49
721 960 106	49
721 960 107	49
721 960 108	49
721 960 109	49
721 960 110	49
721 960 111	49
721 960 112	12
721 960 113	49
721 960 114	49
721 960 116	12
721 960 117	49
721 960 119	49
721 960 120	49
721 960 122	49
721 960 123	49
721 960 303	56
721 960 304	56
721 960 305	56
721 960 306	56
721 960 403	56
721 960 404	56
721 960 405	56
721 960 406	56
721 960 407	56
721 960 408	56
721 960 409	56
721 960 410	56
721 960 411	56
721 960 603	59
721 960 604	59
721 960 605	59
721 960 606	59
721 960 607	59
721 960 608	59
721 960 609	59
721 960 610	59
721 960 611	59
721 960 704	17
721 960 705	17
721 960 706	17
721 960 707	17
721 960 708	17
721 960 709	17
721 960 905	59
721 960 906	59
721 960 907	59
721 960 908	59
721 960 909	59

Code	Page
721 960 910	59
721 960 911	59
721 961 105	12
721 961 106	12
721 961 107	12
721 961 108	12
721 961 109	12
721 961 110	12
721 961 111	12
721 961 113	12
721 961 404	17
721 961 706	18
721 961 707	18
721 961 708	18
721 961 905	60
721 961 906	60
721 961 907	60
721 961 908	60
721 961 909	60
721 961 910	60
721 961 911	60
721 962 115	12
721 964 106	248
721 964 107	248
721 964 108	248
721 964 109	248
721 964 110	248
721 964 111	248
721 964 112	248
721 964 113	248
721 964 114	248
721 964 115	248
721 964 116	248
721 964 117	248
721 964 119	248
721 964 120	248
721 964 156	248
721 964 157	248
721 964 158	248
721 964 159	248
721 964 160	248
721 964 161	248
721 964 162	248
721 964 163	248
721 964 164	248
724 600 206	78
724 600 207	78
724 600 208	78
724 600 209	78
724 600 210	78
724 600 211	78
724 600 212	78

Code	Page
724 600 213	78
724 600 655	76
724 600 656	76
724 600 657	76
724 600 658	76
724 600 659	76
724 600 660	76
724 600 661	76
724 600 705	77
724 600 706	77
724 600 707	77
724 600 708	77
724 600 709	77
724 600 710	77
724 600 711	77
724 600 806	78
724 600 807	78
724 600 808	78
724 600 809	78
724 600 810	78
724 600 811	78
724 600 812	78
724 600 813	78
724 605 505	77
724 605 506	77
724 605 507	77
724 605 508	77
724 605 509	77
724 605 510	77
724 605 511	77
724 690 105	80
724 690 106	80
724 690 107	80
724 690 108	80
724 690 109	80
724 690 110	80
724 690 111	80
724 700 014	214
724 701 406	213
724 701 407	213
724 701 408	213
724 701 409	213
724 701 410	213
724 701 411	213
724 701 412	213
724 701 413	213
724 701 414	213
724 701 415	213
724 701 416	213
724 701 417	213
724 701 419	213
724 701 606	214

Index

Code	Page
724 701 607	214
724 701 608	214
724 701 609	214
724 701 610	214
724 701 611	214
724 701 612	214
724 701 613	214
724 701 615	214
724 701 616	214
724 701 617	214
724 701 720	214
724 701 806	215
724 701 807	215
724 701 808	215
724 701 809	215
724 701 810	215
724 701 811	215
724 701 812	215
724 701 813	215
724 701 815	215
724 701 816	215
724 701 817	215
724 701 820	215
724 703 414	213
724 703 814	215
727 627 001	240
727 627 011	240
727 627 012	240
727 627 021	240
727 627 022	240
727 627 023	240
727 627 031	240
727 627 032	240
727 627 033	240
727 627 041	240
727 627 042	240
727 627 043	240
727 627 044	240
727 627 051	240
727 627 052	240
727 627 053	240
727 627 054	240
727 627 055	240
727 627 061	240
727 627 062	240
727 627 063	240
727 627 064	240
727 627 065	240
727 627 066	240
727 627 071	240
727 627 072	240
727 627 073	240

Code	Page
727 627 074	240
727 627 075	240
727 627 076	240
727 627 081	240
727 627 082	240
727 627 083	240
727 627 084	240
727 627 085	241
727 627 086	241
727 627 087	241
727 627 091	241
727 627 092	241
727 627 093	241
727 627 094	241
727 627 095	241
727 627 096	241
727 627 097	241
727 627 098	241
727 627 101	241
727 627 102	241
727 627 103	241
727 627 104	241
727 627 105	241
727 627 106	241
727 627 107	241
727 627 108	241
727 627 111	241
727 627 112	241
727 627 113	241
727 627 114	241
727 627 115	241
727 627 116	241
727 627 117	241
727 627 118	241
727 627 123	241
727 627 124	241
727 627 125	241
727 627 126	241
727 627 127	241
727 627 128	241
727 627 135	241
727 627 136	241
727 627 137	241
727 627 138	241
727 627 145	241
727 627 146	241
727 627 147	241
727 627 148	241
727 627 156	241
727 627 157	241
727 627 158	241
727 627 166	241

Code	Page
727 627 167	241
727 627 168	241
727 627 176	241
727 627 177	241
727 627 178	241
727 700 206	220
727 700 207	220
727 700 208	220
727 700 209	220
727 700 210	220
727 700 211	220
727 700 212	220
727 700 213	220
727 700 214	220
727 700 215	220
727 700 216	220
727 700 217	220
727 700 219	220
727 700 220	220
727 700 221	220
727 700 222	220
727 700 223	220
727 700 224	220
727 700 225	220
727 700 317	221
727 700 406	218
727 700 407	218
727 700 408	218
727 700 409	218
727 700 410	218
727 700 411	218
727 700 412	218
727 700 413	218
727 700 414	218
727 700 416	218
727 700 417	218
727 700 419	218
727 700 420	218
727 700 421	218
727 700 422	218
727 700 423	218
727 701 206	221
727 701 207	221
727 701 208	221
727 701 209	221
727 701 210	221
727 701 211	221
727 701 212	221
727 701 313	221
727 701 314	221
727 701 319	221
727 701 320	221

Index

Code	Page
727 701 406	219
727 701 407	219
727 701 408	219
727 701 409	219
727 701 410	219
727 701 411	219
727 701 412	219
727 701 413	219
727 701 414	219
727 701 422	219
727 701 423	219
734 600 106	76
734 600 107	76
734 600 108	76
734 600 109	76
734 600 110	76
734 600 111	76
748 400 004	225
748 400 005	225
748 400 006	225
748 400 007	225
748 400 008	225
748 400 009	225
748 400 010	225
748 400 011	225
748 400 012	225
748 400 013	225
748 400 014	226
748 400 015	226
748 400 016	226
748 400 017	226
748 400 018	226
748 400 020	226
748 400 021	226
748 400 022	226
748 400 023	226
748 400 025	226
748 400 026	226
748 400 027	226
748 400 305	227
748 400 306	227
748 400 307	227
748 400 308	227
748 400 309	227
748 400 310	227
748 400 311	227
748 400 312	227
748 400 313	227
748 400 314	227
748 400 315	227
748 400 316	227
748 400 317	227

Code	Page
748 400 319	227
748 400 320	227
748 400 321	227
748 400 322	227
748 400 323	227
748 401 006	229
748 401 007	229
748 401 008	229
748 401 009	229
748 401 010	229
748 401 011	229
748 401 013	229
748 401 014	229
748 401 017	229
748 401 064	229
748 401 109	230
748 401 110	230
748 401 111	230
748 401 113	230
748 401 117	230
748 401 206	230
748 401 207	230
748 401 208	230
748 401 211	230
748 401 213	230
748 401 214	230
748 410 004	81
748 410 005	81
748 410 006	81
748 410 007	81
748 410 008	81
748 410 009	81
748 410 010	81
748 410 011	81
748 410 014	81
748 410 015	81
748 410 016	81
748 410 248	81
748 440 705	228
748 440 706	228
748 440 707	228
748 440 708	228
748 440 709	228
748 440 710	228
748 440 711	228
748 440 712	228
748 440 713	228
748 440 714	228
748 440 715	228
748 440 716	228
748 440 717	228
748 440 719	228

Code	Page
748 440 720	228
748 440 721	228
748 440 722	228
748 440 723	228
748 440 724	228
748 440 725	228
748 440 726	228
748 440 727	228
748 440 728	228
748 440 729	228
749 400 005	225
749 400 006	225
749 400 007	225
749 400 008	225
749 400 009	225
749 400 010	225
749 400 011	225
749 400 012	225
749 400 013	225
749 400 015	226
749 400 016	226
749 400 017	226
749 400 018	226
749 400 020	226
749 400 021	226
749 400 022	226
749 400 025	226
749 400 026	226
749 400 027	226
749 401 109	230
749 401 110	230
749 401 111	230
749 401 113	230
749 401 117	230
749 401 206	230
749 401 207	230
749 401 208	230
749 401 211	230
749 401 213	230
749 401 214	230
749 410 004	81
749 410 005	81
749 410 006	81
749 410 007	81
749 410 008	81
749 410 009	81
749 410 010	81
749 410 011	81
749 410 014	81
749 410 015	81
749 410 016	81
749 410 248	81

Index

Code	Page	Code	Page	Code	Page
749 440 705	228	790 109 002	212	8008160AB	5
749 440 706	228	790 109 003	212	801100	7
749 440 707	228	790 109 011	212	801120	7
749 440 708	228	790 109 012	212	801140N	7
749 440 709	228	790 109 013	212	801160N	7
749 440 710	228	790 202 001	212	801338	8
749 440 711	228	790 309 003	212	801420	8
749 440 712	228	790 309 004	212	801532	8
749 440 713	228	799 198 041	237	801585	8
749 440 714	228	799 270 819	209	806080	6
749 440 715	228	799 271 383	209	806100	6
749 440 716	228	799 271 423	210	806120	7
749 440 717	228	799 298 010	210	806140N	7
749 440 719	228	799 298 028	209	806160N	7
749 440 720	228	799 299 001	211	817100	7
749 440 721	228	799 299 002	211	817120	7
749 440 722	228	799 299 003	211	817140N	7
749 440 723	228	799 299 004	211	817160N	7
749 440 724	228	799 299 005	211	829100	9
749 440 725	228	799298002.	209	829101	11
749 440 726	228	799298003.	209	829120	9
749 440 727	228	800 000 182	101	829130	11
749 440 728	228	800 000 183	101	829131	11
749 440 729	228	800 000 184	101	829140N	9
752 910 105	46	800 000 185	101	829160N	9
752 910 106	46	800 000 186	101	829168	11
752 910 107	46	800 000 187	101	829209FB	11
752 910 108	46	800 000 192	101	829210	11
752 910 109	46	800 000 193	101	829211	11
752 910 110	46	800 000 194	101	829212	11
752 910 111	46	800 000 195	101	829247FB	11
753 508 616	76	800 000 196	101	829248FB	11
753 508 617	76	800 000 197	101	829249	11
753 508 618	76	800 015 100	134	829250	11
753 508 619	76	800 015 101	134	829251	11
753 508 620	76	800 017 580	134	829337FB	11
753 508 621	76	800 026 279	134	829338	11
753 911 610	234	800 026 280	134	829420FB	11
753 911 611	234	800 026 281	134	829422	11
753 911 612	234	8008005AB	5	829532	11
753 911 613	234	8008007AB	5	829582FB	11
753 911 614	234	8008010AB	5	829585	11
753 911 615	234	8008012AB	5	829623N	11
753 911 616	234	8008015AB	5	829626FB	11
753 911 817	234	8008020AB	5	829626N	11
753 911 818	234	8008030AB	5	829628FB	11
753 911 819	234	8008040AB	5	829628N	11
753 911 820	234	8008060AB	5	829668FB	11
753 911 821	234	8008080AB	5	829668N	11
753 911 822	234	8008100AB	5	829670FB	11
753 911 823	234	8008120AB	5	829670N	11
790 109 001	212	8008140AB	5	829702N	11

Index

Code	Page
829704N	11
829738N	11
829740N	11
835005	16
835007	16
835010	16
835012	16
835015	16
835020	16
835030	16
835040	16
836005	14
836007	14
836010	14
836012	14
836015	14
836020	14
836030	14
836040	14
837420	10
837530	10
837532	10
837626FB	10
837628	10
837668FB	10
837670	10
837702N	10
837704N	10
837738N	10
837740N	10
847060	12
847080	12
847100	12
847120	12
847140	12
847160	12
854005	21
854007	21
854010	21
854012	21
854015	21
854020	21
854030	21
854040	21
854060	21
854080	21
854100	21
854120	21
854140N	21
854160N	21
870060	8
870080	8

Code	Page
875100N	8
875120N	8
875140N	8
875160N	8
999 950 001	185
999 950 002	185
999 950 003	185
999 950 004	185
999 950 005	185
999 950 006	185
999 950 007	185
999 950 008	185
999 950 009	185
999 950 010	185
999 950 011	185
999 950 012	185

Stockist



George Fischer Sales Limited
Paradise Way, Coventry CV2 2ST
Tel. 024 7653 5535, Fax. 024 7653 0450
email uk.ps@georgefischer.com
website www.georgefischer.co.uk